

INSTRUCTIONS FOR USE

Carevo



WARNING

To avoid injury, always read this Instructions for Use and accompanied documents before using the product.



Mandatory to read the Instructions for Use

Design Policy and Copyright

® and ™ are trademarks belonging to the Arjo group of companies. © Arjo 2019.

As our policy is one of continuous improvement, we reserve the right to modify designs without prior notice. The content of this publication may not be copied either whole or in part without the consent of Arjo.

Contents

Foreword	4
Intended Use	5
Safety Instructions	6
Preparations	7
Carevo Shower Trolley Models	8
Carevo Shower Trolley Directions	9
Parts Designation	10
Product Description / Functions	12
Control Panel	12
Button Functions	12
Castor Brakes	12
Straight Steering Device	12
Emergency Stop Button	13
Safety Stop Function	13
Ergo-access Area	13
Flexi Zone	13
Comfort Handles	14
Side Supports	14
Adjustable Back Support	15
Attach/Remove Mattress	15
Drainage Plug	16
Drainage	16
Head Pillow	17
Shower Handle Holder	17
Battery	17
Transfer from the Bed	18
Transfer to the Bed	21
Transfer from the Sling Lift.....	24
Transfer to the Sling Lift	26
Shower the Patient.....	28
Home Care Use	32
Cleaning and Disinfection Instructions	34
Battery Instructions	38
Care and Preventive Maintenance	39
Alarms and Sounds	42
Troubleshooting	43
Technical Specifications	44
Dimensions	46
Labels	48
List of Standards and Certificates	50
Electromagnetic compatibility	52
Parts and Accessories	54

Foreword

Thank You for Purchasing Arjo Equipment.

Your *Carevo*[™] shower trolley is a part of a series of quality products designed especially for hospitals, nursing homes and other health care use.

Please contact us if you have any questions about the operation or maintenance of your Arjo equipment.

Please Read these Instructions for Use Thoroughly!

Please read this *Instructions for Use (IFU)* in its entirety before using your *Carevo* shower trolley. Information in this *IFU* is crucial to the proper operation and maintenance of the equipment. It will help protect your product and make sure that the equipment performs to your satisfaction. The information in this *IFU* is important for your safety and must be read and understood to help prevent possible injury.

Unauthorized modifications on any Arjo equipment may affect its safety. Arjo will not be held responsible for any accidents, incidents or lack of performance that occur as a result of any unauthorized modification to its products.

Report Unexpected Operations or Events

Contact your local Arjo representative if any unexpected operations or events occur. The contact information appear on the last page of this *IFU*.

Serious incident

If a serious incident occurs in relation to this medical device, affecting the user, or the patient then the user or patient should report the serious incident to the medical device manufacturer or the distributor. In the European Union, the user should also report the serious incident to the Competent Authority in the member state where they are located.

Service and Support

A service routine must be performed on your *Carevo* shower trolley every year by qualified personnel to make sure the safety and operating procedures of your product. See section *Care and Preventive Maintenance on page 39*.

If you require further information, please contact Arjo for comprehensive support and service programs to

maximize the long-term safety, reliability and value of the product.

Contact your local Arjo representative for replacement parts. See contact information on the last page of this *IFU*.

Complementary Information

If a DVD accompanies this *IFU*, please note that the DVD does not replace the information in this *IFU*. The *IFU* contains additional important safety instructions.

Definitions in this IFU:

WARNING

Means:

Safety warning. Failure to understand and obey this warning may result in injury to you or to others.

CAUTION

Means:

Failure to follow these instructions may cause damage to all or parts of the system.

NOTE

Means:

This is important information for the correct use of this system or equipment.

TIPS

Means:

This is information that will ease a certain task in the work flow.



Means:

The name and address of the manufacturer.

Intended Use

This equipment must be used in line with its intended use and in accordance with the safety instructions.

If there is anything you are not sure about, contact your Arjo representative.

This equipment is intended for assisted hygiene care, especially dressing/undressing and showering of patients in care environments like senior/assisted living, group home, special care, nursing homes, hospitals and home care.

The *Carevo* shower trolley equipment must be used by appropriately trained caregivers with adequate knowledge of the care environment, its common practices and procedures, and in accordance with the guidelines in the Instructions for Use.

The patient transfer to and from the *Carevo* shower trolley can be performed with a ceiling lift, mobile passive lift or by lateral transfer to and from a bed, using an appropriate sliding aid.

The *Carevo* shower trolley should only be used for the purpose specified in these *Instructions for Use (IFU)*. Any other use is prohibited.

Patient Assessment

We recommend that facilities establish regular assessment routines. Caregivers should assess each patient according to the following criteria prior to use:

- The product is intended mainly for patients who are passive and totally dependent. To remain in a safe laying position on the *Carevo* shower trolley, the patient must have limited physical capacity to move or be able to understand and respond to instructions to remain in such a position. If the patient does not meet this description, an alternative equipment/system shall be used.
- Prior to transfers and other patient handling, assessment of the patient and environment shall be performed so that staffing is in accordance with the need for the specific task.
- The patient weight shall not exceed 182 kg (400 lbs.)
- The product is intended for patients taller than 120 cm (3 feet 11 inches)

Lifetime of the Equipment

The expected lifetime of this equipment is ten (10) years but depending on the storage of the battery, the use frequency and the charging intervals, the service life of the battery is 2-5 years.

The lifetime and service life are stated providing that the preventive maintenance are being carried out in accordance with the instructions for care and maintenance in the *Instructions for use (IFU)*.

Depending on level of wear some equipment parts such as castors and mattress may need to be replaced during the equipment lifetime according to information in the Instructions for Use (IFU).

Safety Instructions

WARNING

To avoid injury, make sure that the patient is not left unattended at any time.

WARNING

To avoid the patient from falling out of the device, make sure that all side supports are in a locked position.

WARNING

To avoid the device from tipping and the patient from falling, do not use the equipment on floor with recessed drains, holes or slopes exceeding a ratio of 1:50 (1.15°).

WARNING

To avoid falling during transfer, always make sure that the brakes are applied on all equipment being used.

WARNING

To avoid the device from tipping and the patient from falling, do not sit on the head or foot end of the device.

WARNING

To avoid explosion or fire, never use the equipment in oxygen rich environment, in presence of heat source or flammable anaesthetic gases.

CAUTION

To avoid equipment damage only lift one end (head end or foot end) of the *Carevo* shower trolley at a time. Never lift the foot end and the head end at the same time.

CAUTION

To avoid equipment damage, never use sharp objects in the presence of the *Carevo* shower trolley. It can cause punctures on the mattress.

Preparations

Actions Before the First Use

(11 Steps)

- 1 Visually inspect the *Carevo* shower trolley for transport damage.
- 2 The package should be recycled according to local regulations.
- 3 Check that all parts of the product are supplied. Compare with section *Parts Designation on page 10*. If any part is missing or damaged - do not use the product!
- 4 Read the *IFU*.
- 5 Unpack the battery charger. For charging and charger installation instructions see *NEA 8000 Battery Charger IFU*.
- 6 Charge the battery for 24 hours.
- 7 Perform a functionality test on the *Carevo* shower trolley. See section *Care and Preventive Maintenance on page 39*.
- 8 Disinfect the product. See section *Care and Preventive Maintenance on page 39*.
- 9 Prepare an area that is dry, with good ventilation and out of direct sunlight for storage of the *Carevo* shower trolley.
- 10 Choose a designated area where the *IFU* should be kept, accessible at all times.
- 11 Make sure to have a rescue plan ready in case of a patient emergency.

Actions Before Every Use

(5 Steps)

- 1 Check that all parts are in place. Compare with section *Parts Designation on page 10*.
- 2 Carry out a thorough inspection for damage, including mattress punctures.
- 3 If any part is missing or damaged - do NOT use the product!
- 4

<p>WARNING</p> <p>To prevent cross-contamination always follow the disinfection instructions in this IFU.</p>

- 5 Make sure that the battery is fully charged. See the *NEA 8000 Battery Charger IFU*.

NOTE

If you have any questions, please contact your local Arjo representative for support and service. See contact information on the last page of this IFU.

Carevo Shower Trolley Models

Carevo shower trolley without adjustable back support (standard)

BAC1101-01 (Europe and North America)

BAC1102-01 (Japan)

BAC1103-01 (Australia)

Length: 2000 mm (78 3/4" inches)

Carevo shower trolley with an adjustable back support

BAC1111-01 (Europe and North America)

BAC1112-01 (Japan)

BAC1113-01 (Australia)

Length: 2000 mm (78 3/4" inches)

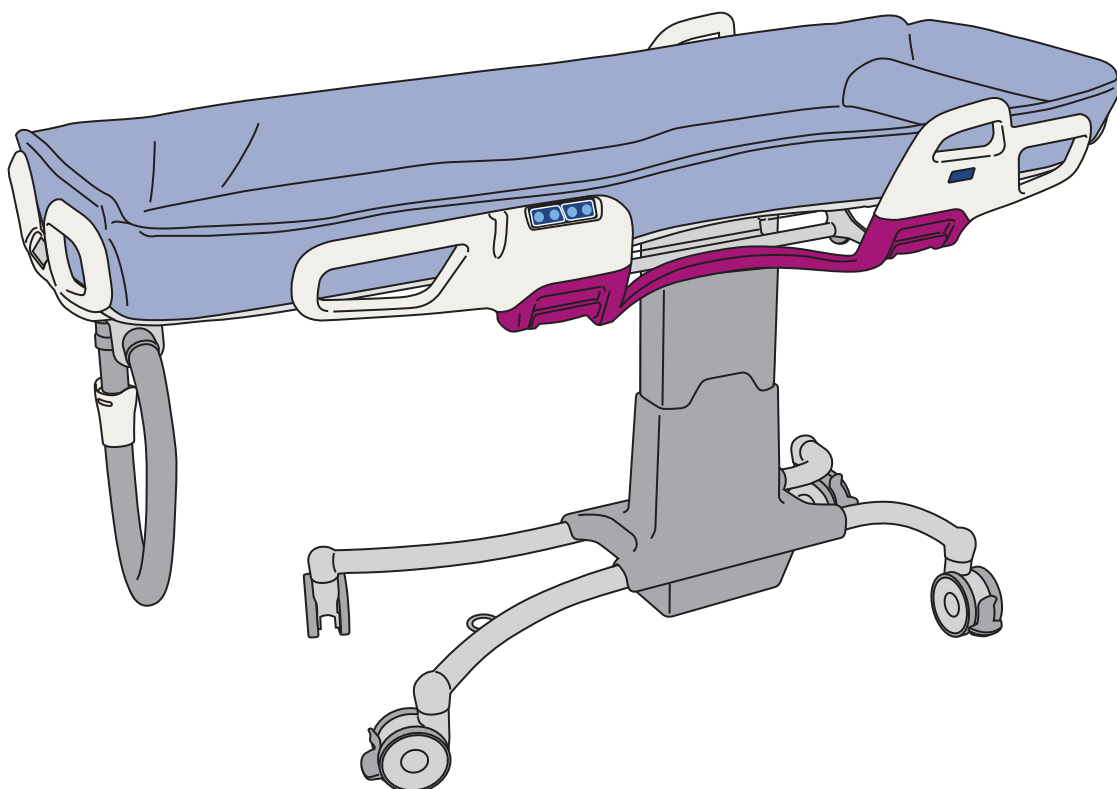

Carevo Shower Trolley Directions

Fig. 1

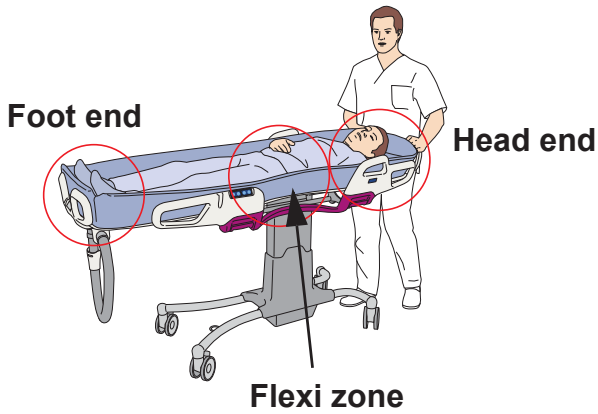

Position the patient in the *Carevo* shower trolley with the patient's head towards the head end and feet towards the foot end. Make sure the patient's hips are centrally positioned over the flexi zone. (See Fig. 1)

NOTE

The *Carevo* shower trolley is designed with a slight tilt down towards the drain.

Fig. 2

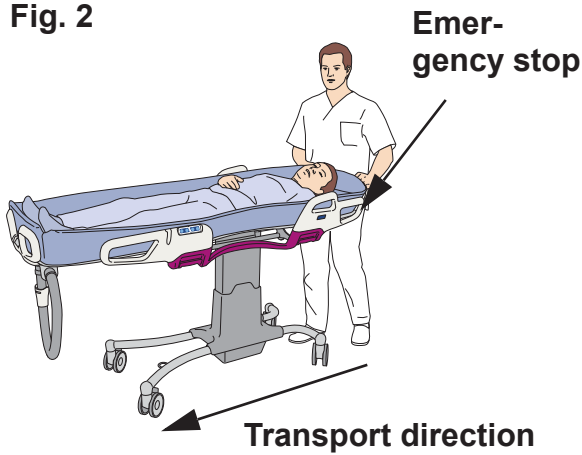

The caregiver needs to be positioned at the head end of the *Carevo* shower trolley during transport. In case of an emergency the caregiver will be close to the emergency stop button. (See Fig. 2)

Parts Designation

The Carevo shower trolley includes the following parts:

- 1 Mattress
- 2 Control panels (one on each side support and head panel)
- 3 Head pillow
- 4 Opening handles
- 5 Castor brake lever (located all four castors)
- 6 Lower drainage
- 7 Drainage connection
- 8 Upper drainage
- 9 Lower drainage outlet
- 10 Mattress guide holes (one on each support plate)
- 11 Support plates
(one for the head end and one for the foot end)
- 12 Shower handle holder
- 13 Flexi zone
- 14 Comfort handles
- 15 Head panel
- 16 Side support (one on each side of the *Carevo* shower trolley)
- 17 Pillar
- 18 Castor base
- 19 Drainage hose holders
- 20 Foot panel
- 21 Mattress guides
- 22 Drainage plug
- 23 Emergency stop button
- 24 Battery
- 25 Battery compartment
- 26 Straight steering lever (green lever on two castors)



Entire Product
Applied part: Type BF
Protection against electric shock in accordance
with IEC 60601-1.

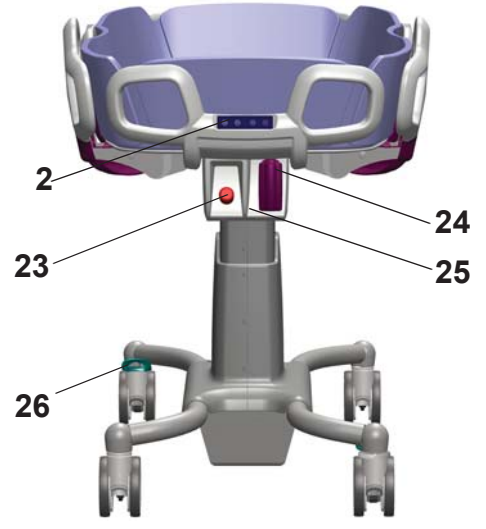
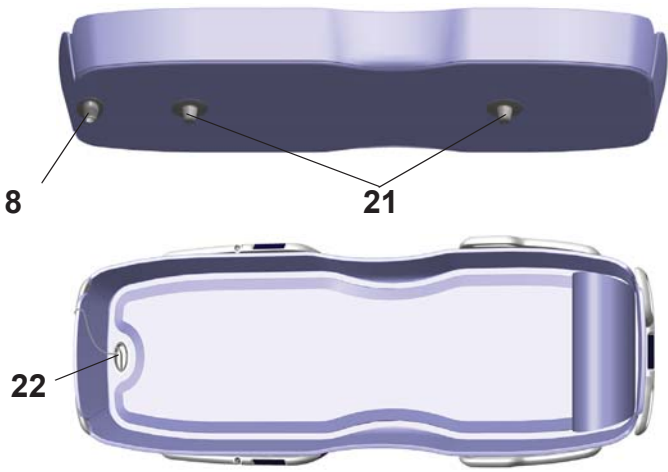
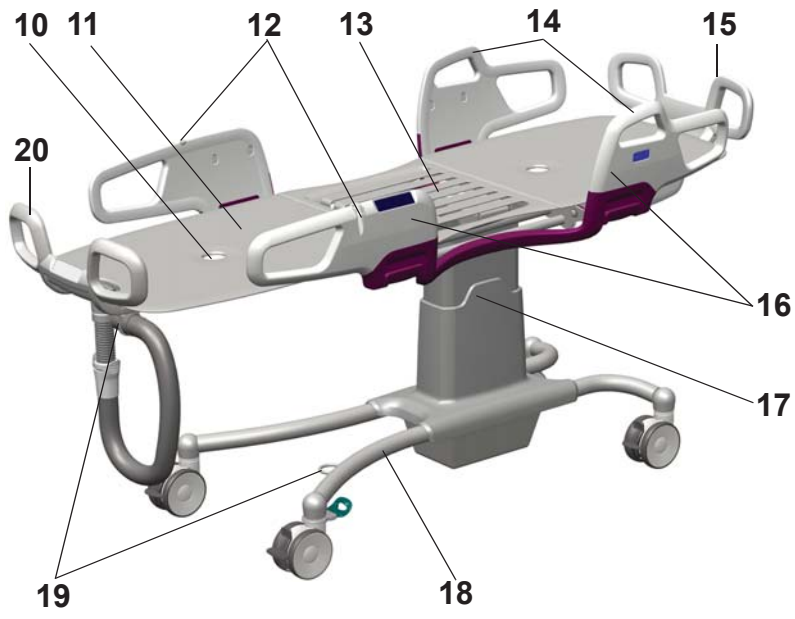
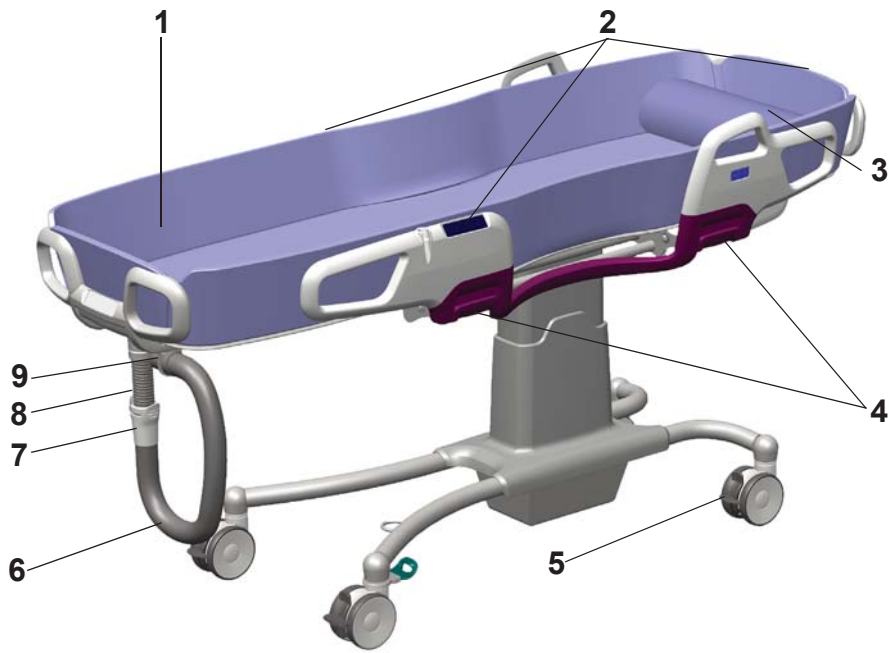

Product Description / Functions

Fig. 1

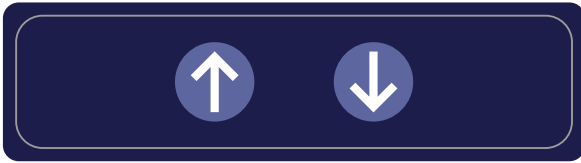

Control Panel

The control panel is located on each side support and on the head panel. There are two types of control panels depending on the *Carevo* shower trolley model. The models are:

- the *Carevo* shower trolley model without adjustable back support (See Fig. 1)
- the *Carevo* shower trolley model with adjustable back support (See Fig. 2)

Fig. 2



Button Functions



Press to raise the *Carevo* shower trolley.



Press to lower the *Carevo* shower trolley.



Press to raise the adjustable back support.



Press to lower the adjustable back support.

Fig. 3

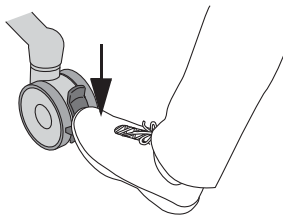

Castor Brakes

The castor brakes are located on all four castors.

Apply the brakes:

Press down on the gray castor brake lever. (See Fig. 3)

Release the brakes:

Slightly kick up the gray castor brake lever. (See Fig. 4)

Fig. 4

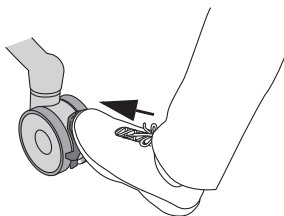
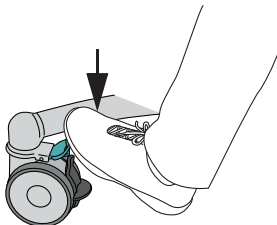

Fig. 5



Straight Steering Device

Most often used when one caregiver is transporting the *Carevo* shower trolley. For easier manoeuvring in corridors and around corners, use the straight steering device. The straight steering devices are green and located on two castors diagonally from each other.

Apply the straight steering lever furthest away from where the caregiver is standing. Do not apply both straight steering levers, since it will make the *Carevo* shower trolley hard to manoeuvre.

Apply straight steering: press down on the green straight steering lever. (See Fig. 5)

Release the straight steering: slightly kick up the green straight steering lever. (See Fig. 6)

Fig. 6

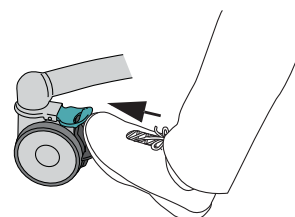
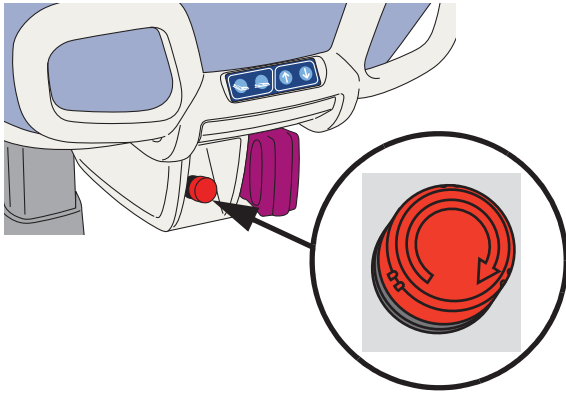

Fig. 1



Emergency Stop Button

The emergency stop button is not intended to interrupt operation during normal use. If, for any reason the *Carevo* shower trolley does not respond to the control panel, push the emergency stop button to stop any movement. (See Fig. 1) Contact qualified personnel if that happens.

If the emergency button is pushed in by accident, turn the emergency stop button clockwise to reset it. The emergency stop button will pop back out by itself.

Fig. 2

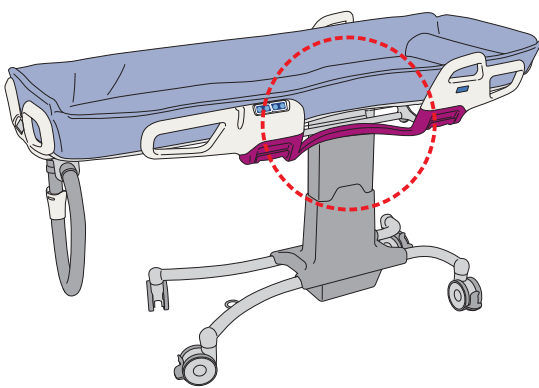

Safety Stop Function

If the *Carevo* shower trolley is stopped by an object during lowering, the safety stop function will automatically be activated. Raise the *Carevo* shower trolley and move it away from the object and continue lowering.

Ergo-access Area

The ergo-access area is located in the middle of each side support. (See Fig. 2)

It is designed for the caregiver to be able to:

- stand in a more ergonomic posture and
- be able to reach the patient better.

TIPS

Use the ergo-access area to better reach the patient. Remember to move around the *Carevo* shower trolley to avoid twisting and leaning forward when standing in the ergo-access area.

Fig. 3

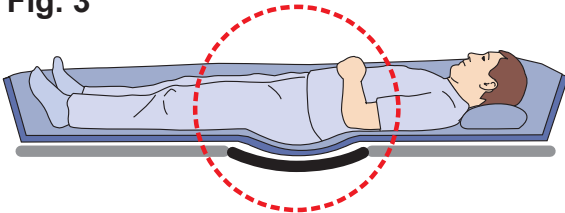

Flexi Zone

The flexi zone is constructed as a suspension area to distribute pressure on the patient's lower back, coccyx and hips. (See Fig. 3)

For an optimal comfort level, position the patient's buttocks centrally in the flexi zone.

The mattress has a graphic outline with an illustrated human figure on each side. Position the patient's buttocks within the graphic outline on the mattress. (See Fig. 4)

Bend the patient's knee to better see if the patient's buttocks are positioned correctly within the graphic outline. Align the patient's hip crease with the illustrated human figures. (See Fig. 5)

Fig. 4

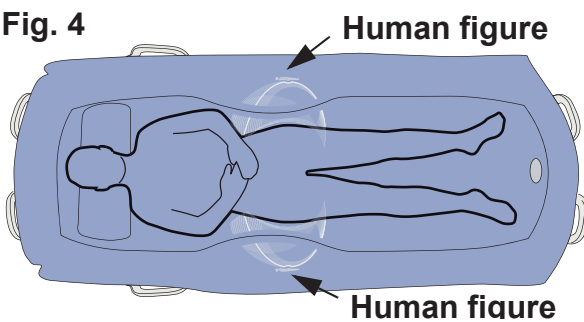

Fig. 5

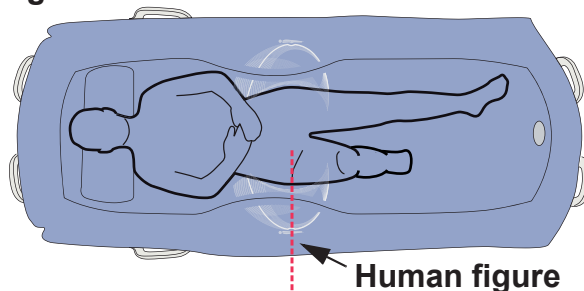
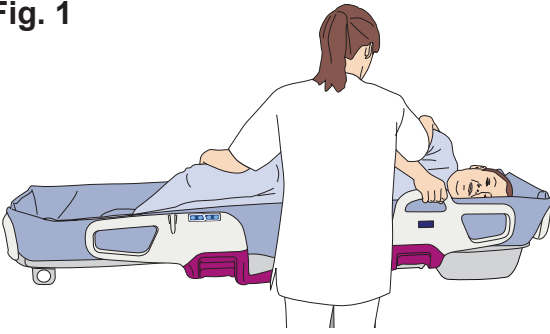

Fig. 1



Comfort Handles

There are two comfort handles located on the *Carevo* shower trolley, one on each side support. The patient can use the comfort handle as support when laying on the side. Holding on to the comfort handle can add a sense of security for the patient as well as a feeling of being able to help out. (See Fig. 1)

Side Supports

The two side supports are there to secure the patient.

WARNING

To avoid the patient from falling out of the device make sure that all side supports are in a locked position.

The side support has three positions

(See Fig. 2)

- A Inner position,
- B Outer position
- C Down folded position

Fig. 2

View from head/foot end

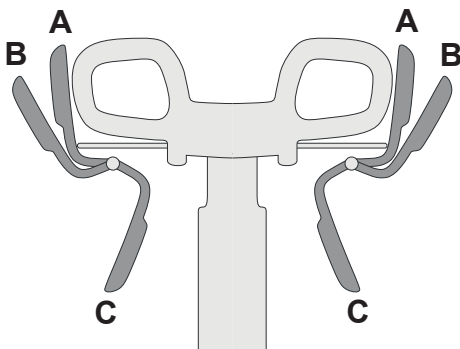
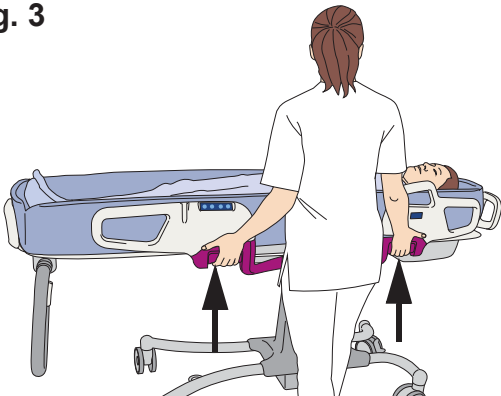

Fig. 3



Fold down the side support

Lift both opening handles up on the side support and let the side support fall towards you. (See Fig. 3)

Fig. 4

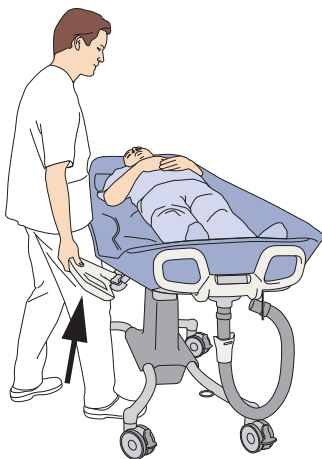

Fold up the side support from down folded position

Pull the side support up. Depending on the speed of the side support being pulled, it can lock in either the outer or inner position. For the outer position, pull up more slowly. (See Fig. 4)

Change between inner position and outer position

Lift the opening handles and raise/lower the side support to the selected position until it locks and clicks into place.

TIPS

Before rolling a patient, adjust the side support to the outer position for more space.

Fig. 1

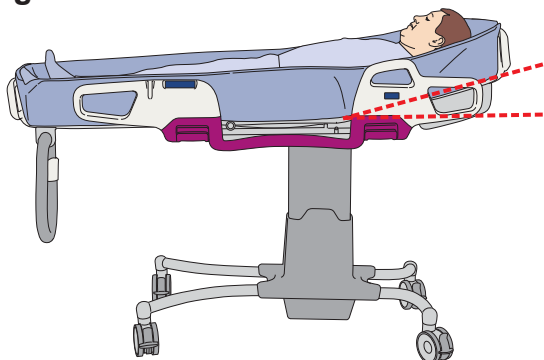

Adjustable Back Support

Some *Carevo* shower trolley models (*BAC1111-01*, *BAC1112-01* and *BAC1113-01*) are equipped with an electrical adjustable back support. Use the control panels to operate the adjustable back support. (See Fig. 1)



Press to raise the adjustable back support.



Press to lower the adjustable back support.

Fig. 2

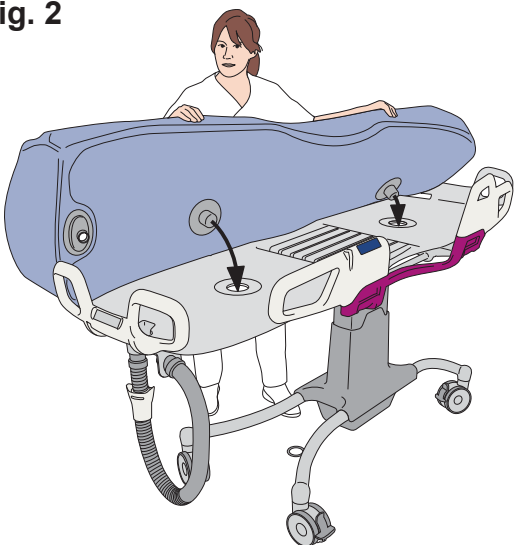

CAUTION

To avoid the *Carevo* shower trolley adjustable back support from electrical overheating during constant use of lowering/raising, make sure to lower/raise the back support for a maximum of 2 minutes. Then wait for 6 minutes before lowering/raising the back support again.

Attach/Remove Mattress

Attach

Find the position of the drainage outlet and let the mattress guides fall into the mattress guide holes located on the support plates. (See Fig. 2)

Fig. 3

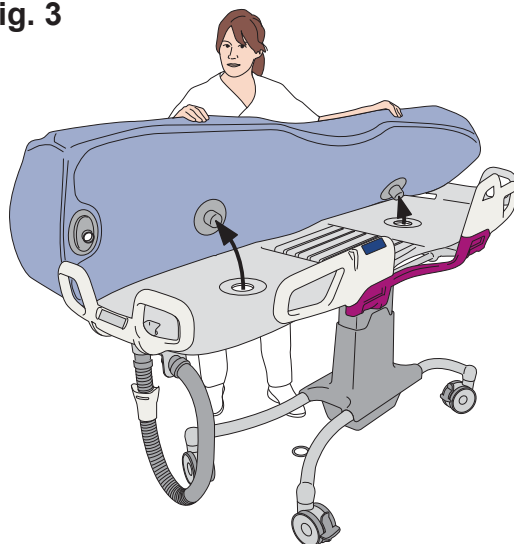

Remove

- 1 Remove the drainage plug from the mattress.
- 2 Pull the mattress up and away from the support plates. (See Fig. 3)

Fig. 1

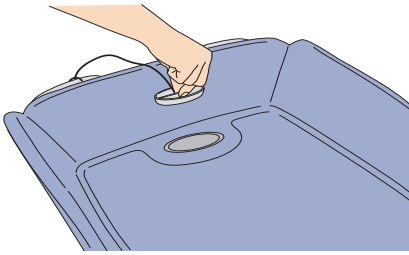

Drainage Plug

Place the drainage plug in the mattress drainage for shallow bathing. Remove the drainage plug during showering.

(See Fig. 1)

The drainage plug is attached to the foot panel by a string. When not in use let it hang freely.

Fig. 2

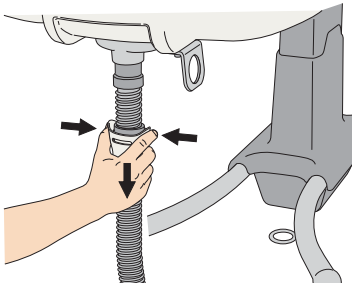

Drainage

The *Carevo* shower trolley upper drainage and a lower drainage is located under the foot panel.

Remove the lower drainage:

Grab and squeeze the sides of the lower drainage connector and pull it down. **(See Fig. 2)**

Fig. 3

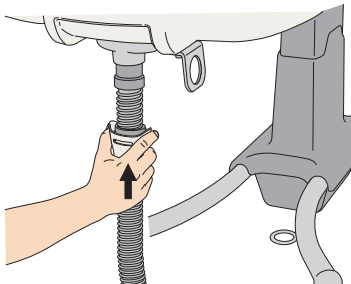

Attach the lower drainage:

Push the lower drainage with the drainage connector up to the upper drainage until it clicks into place. **(See Fig. 3)**

Fig. 4

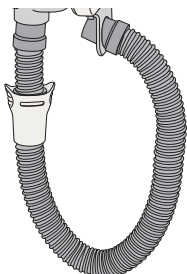

Position of drainage hose during transport/storage:

Connect the lower drainage outlet to the drainage hose holder located on the foot panel. **(See Fig. 4)**

Fig. 5

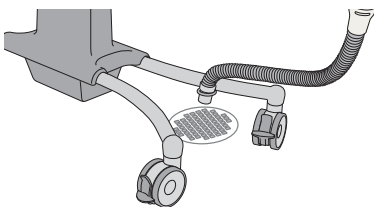

Position of drainage hose during a shower:

Connect the lower drainage outlet to the drainage hose holder on the castor base and position it over the floor drain, **(See Fig. 5)**
or:

Completely remove the lower drainage and position the upper drainage over a toilet or a flush sink. **(See Fig. 6)**

Fig. 6

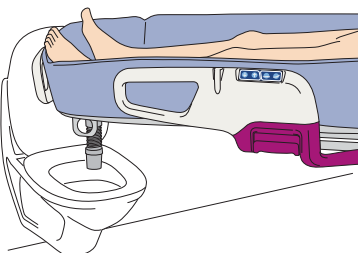
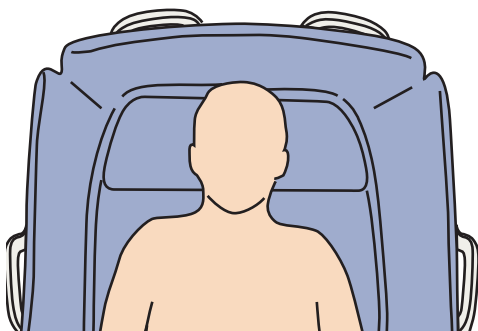

Fig. 1



Head Pillow

The head pillow is shaped to fit into the head end of the mattress. Position it according to the illustration. (See Fig. 1)
The head pillow provides warmth and comfort for the patient.

Fig. 2

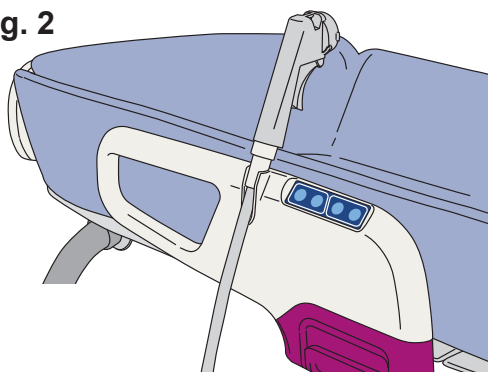

Shower Handle Holder

The shower handle holder is located on each side support. Attach the shower handle to the shower handle holder when needed. (See Fig. 2)

- For the caregiver, the attachment will provide a better reach of the shower handle during the shower routine.
- For the patient, the attached shower handle can be used to sprinkle water over the patient, to keep him/her warm.

Fig. 3

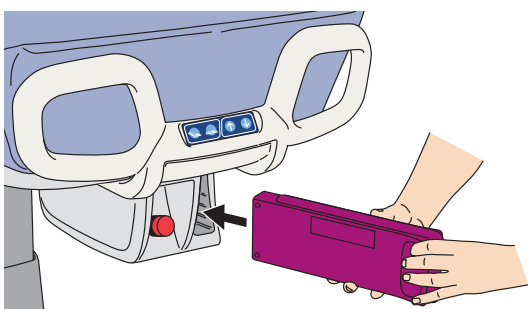

Battery

The battery is located under the head panel. The *Carevo* shower trolley uses the NEA0100-083 battery. (See Fig. 3)

The rounded ridge of the battery needs to be upward when inserting it into the *Carevo* shower trolley battery compartment. (See Fig. 4)

Remove the battery by pulling it straight out.

Fig. 4

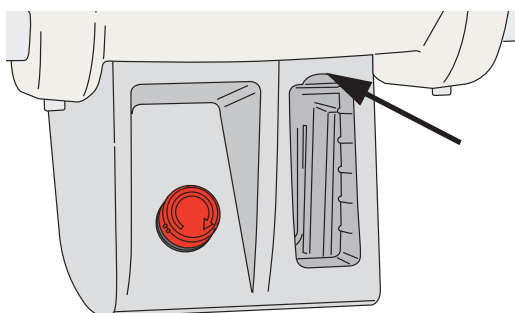

Low charge warning

A buzzer sound will go off when the battery reaches a low charge. The battery should then be recharged as soon as possible.

For charger and charger installation instructions, see *NEA 8000 Battery Charger IFU*.

Transfer from the Bed

Fig. 1

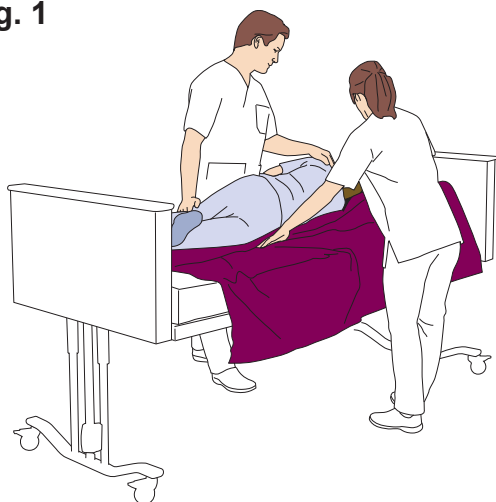

Fig. 2

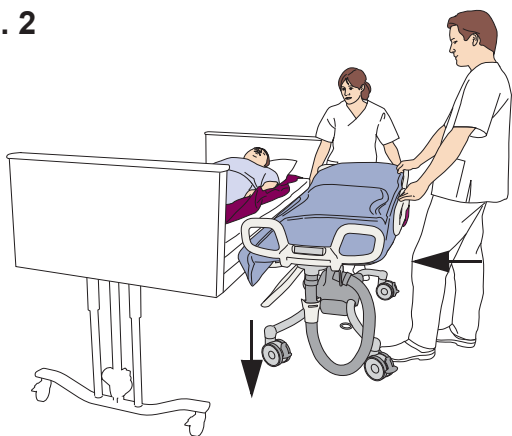
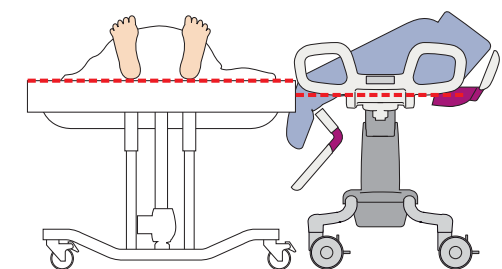

Fig. 3



Lateral Transfer

(21 Steps)

(For lateral transfers always use a sliding aid. For sliding aid instructions, see respective sliding aid *IFU*.)

- 1 Fold down the *Carevo* shower trolley side support on the transfer side and lower the adjustable back support, if available.
- 2 Apply the brakes on the bed.
- 3 Adjust the bed to an ergonomic height.
- 4 Place the sliding aid (tube/sheet) under the patient. (Use local technique) (See Fig. 1)
- 5 Place a pillow under the patient's head.
- 6 Fold down the bed rail on the transfer side.
- 7 Position the *Carevo* shower trolley next to the bed's transfer side.
- 8 Fold down the *Carevo* shower trolley mattress on the transfer side. Press down and fixate the *Carevo* shower trolley mattress corners between the head/foot panel and support plate. (See Fig. 2)
- 9 Adjust the *Carevo* shower trolley height so that its slightly lower than the bed. (See Fig. 3)

NOTE

If there is a gap between the bed and the *Carevo* shower trolley, place a sliding board in between the two to bridge the gap.

10 **WARNING**

To avoid the device in use from tipping, do not raise or lower other equipment close to it and be aware of stationary object when lowering.

Push the *Carevo* shower trolley against the bed.

Continue with the steps on the next page.

Fig. 4

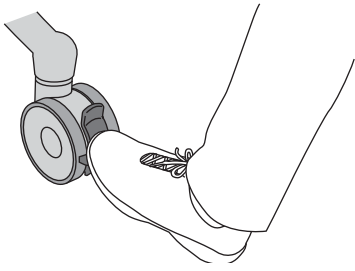

11 **WARNING**

To avoid falling during a transfer always make sure that the brakes are applied on all equipment being used.

Apply all four castor brakes on the *Carevo* shower trolley. (See Fig. 4)

Fig. 5



12 **WARNING**

To avoid the device in use from tipping, do not raise or lower other equipment close to it and be aware of stationary object when lowering.

Transfer the patient with the sliding aid (tube /sheet) from bed to the *Carevo* shower trolley. Make sure to keep an eye on the patient's head during the transfer. Examples of transfer with a sliding aids are:

- Tube (See Fig. 5)
- Sliding sheet (See Fig. 6)

Fig. 6

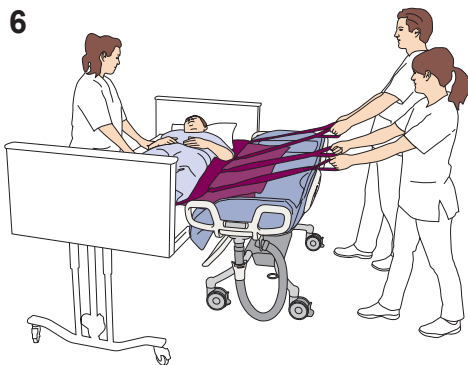

NOTE

The number of caregivers and their positions during the transfer depends on the sliding aid being used and the patient assessment.

- 13 If the mattress accidentally gets bumped out of position, it will create bumps under the mattress. This can be uncomfortable for the patient to lie on. Make sure the mattress is in its right position.

Fig. 7

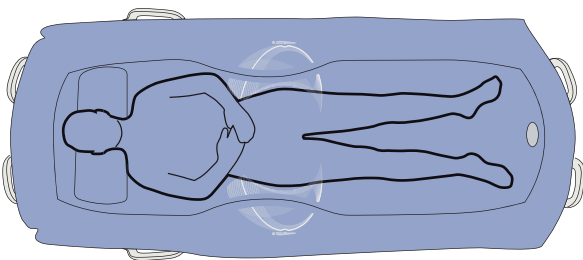

14 **WARNING**

To make sure that the patient cannot slip out through the side support, make sure that the mattress sides are up and not folded underneath the patient.

Fig. 8

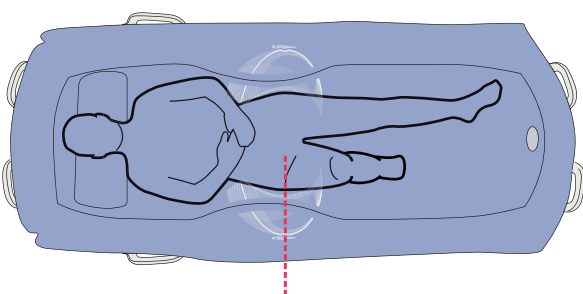

For better comfort, position the patient correctly on the flexi zone. Make sure the patient's buttocks are within the graphic outline on the mattress. (See Fig. 7)

The patient's hip creases should be aligned with the illustrated human figure. Use the sliding aid to adjust the patient's position. (See Fig. 8)

Continue with the steps on the next page.

Fig. 9



15 Replace the bed pillow with the *Carevo* shower trolley head pillow.

16 Remove the sliding aid from under the patient's body. (Use local technique) (See Fig. 9)

17 Release the castor brakes on the *Carevo* shower trolley. (See Fig. 10)

18 **WARNING**
To avoid entrapment make sure to keep the patient's hair, arms and feet close to the body and use designated grab supports during any movement.

Fig. 10

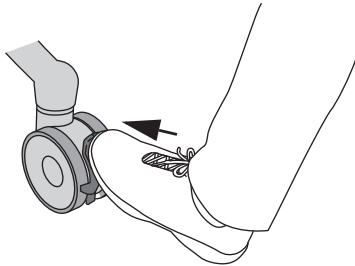
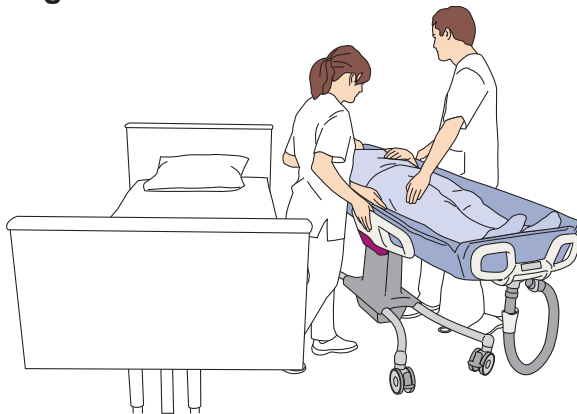

Fig. 11



WARNING
To avoid the patient from falling out of the device make sure that all side supports are in a locked position.

Carefully move the *Carevo* shower trolley away from the bed enough to fold up the side support on the *Carevo* shower trolley. (See Fig. 11)

Fig. 12

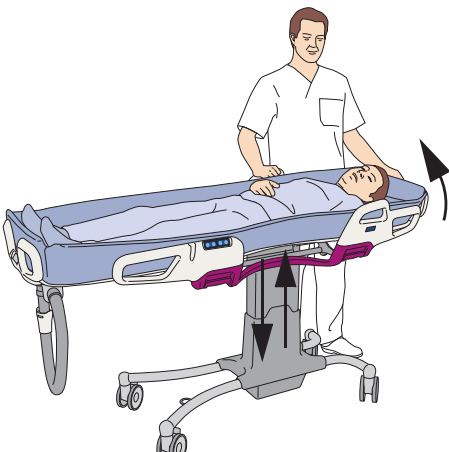

19 Adjust the *Carevo* shower trolley to an ergonomic height. (See Fig. 12)

20 Raise the *Carevo* shower trolley adjustable back support, if available. (See Fig. 12)

21 Transport the patient to the bath room.

Transfer to the Bed

Fig. 1

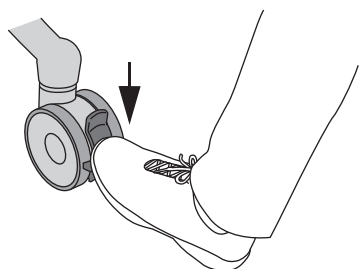

Fig. 2



Fig. 3

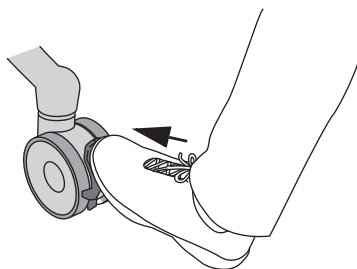
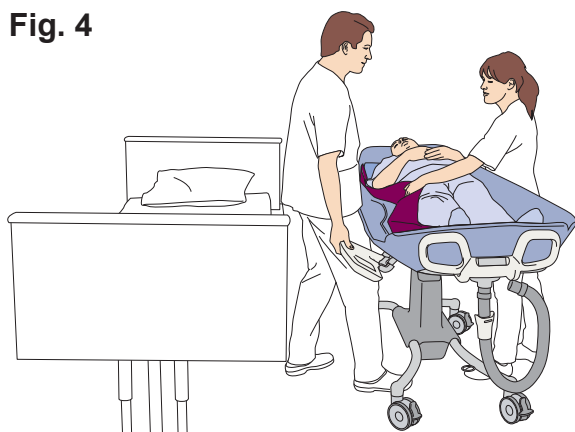

Fig. 4



Lateral Transfer

(20 Steps)

(For lateral transfers always use a sliding aid. For sliding aid instructions, see respective sliding aid *IFU*.)

- 1 Apply the brakes on the bed.
- 2 Adjust the bed to an ergonomic height.
- 3 Fold down the bed rail on the transfer side.
- 4 Apply all four castor brakes on the *Carevo* shower trolley. (See Fig. 1)
- 5 Lower the adjustable back support on the *Carevo* shower trolley, if available.
- 6 Place the sliding aid under the patient. (Use local technique) (See Fig. 2)
- 7 Release the castor brakes on the *Carevo* shower trolley. (See Fig. 3)
- 8 Position the *Carevo* shower trolley close to the bed with enough space to later fold down the *Carevo* shower trolley side support on the transfer side.
- 9 Adjust the *Carevo* shower trolley height so that it is slightly higher than the bed.

10 **WARNING**

To avoid entrapment make sure to keep the patient's hair, arms and feet close to the body and use designated grab supports during any movement.

Position the *Carevo* shower trolley close to the bed and fold down the *Carevo* shower trolley side support on the transfer side. (See Fig. 4)

Continue with the steps on the next page.

Fig. 5

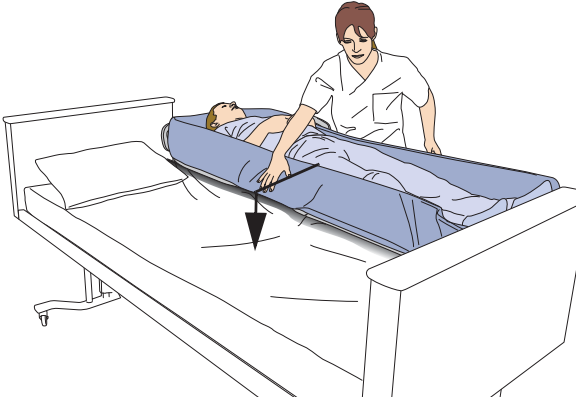

11 Immediately place the *Carevo* shower trolley so that it is overlapping the bed. (See Fig. 5)

12 **WARNING**

To avoid the device in use from tipping, do not raise or lower other equipment close to it and be aware of stationary object when lowering.

Lower the *Carevo* shower trolley on the bed for an even transfer. (See Fig. 5)

Fig. 6

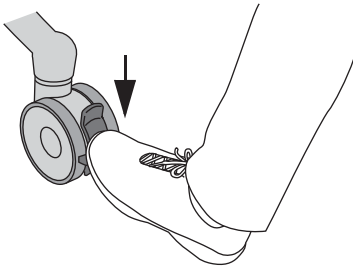

13 **WARNING**

To avoid falling during a transfer always make sure that the brakes are applied on all equipment being used.

Apply all four castor brakes on the *Carevo* shower trolley. (See Fig. 6)

Fig. 7

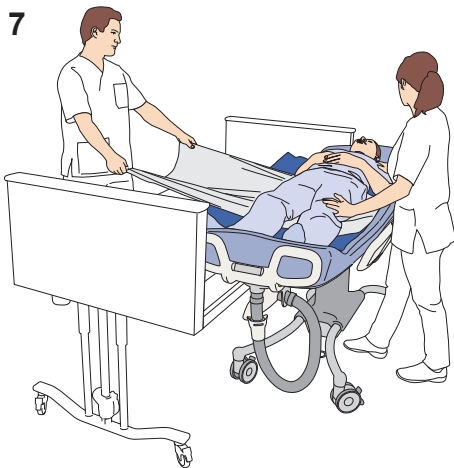

14 Make sure the *Carevo* shower trolley mattress is on top of the bed.

15 Transfer the patient with the sliding aid (tube/sheet) from the *Carevo* shower trolley to bed. Make sure to keep an eye on the patient's head during the transfer.

Examples of transfer with a sliding aids are:

- Tube (See Fig. 7)
- Sliding sheet (See Fig. 8)

Fig. 8

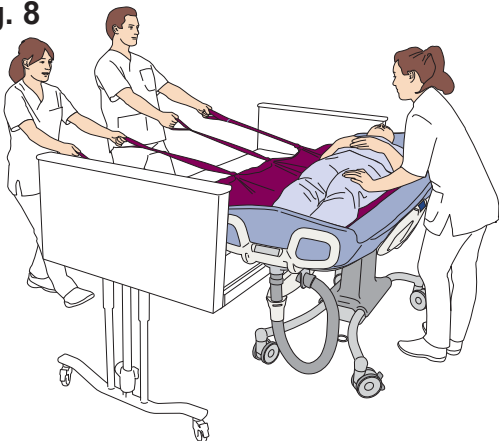

NOTE

The number of caregivers and their positions during the transfer depends on the sliding aid being used and patient assessment.

Continue with the steps on the next page.

Fig. 9

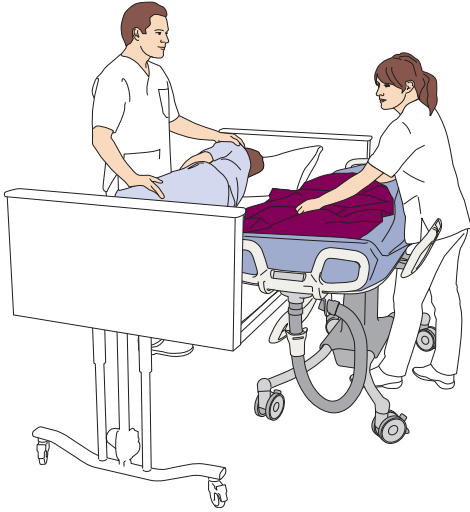

16 Make sure to replace the *Carevo* shower trolley head pillow with a bed pillow under the patient's head.

17 Remove the sliding aid under the patient. (Use local technique) (See Fig. 9)

18 Release the castor brakes on the *Carevo* shower trolley. (See Fig. 10)

19 Move the *Carevo* shower trolley away from the bed.

20 Disinfect the *Carevo* shower trolley. See section *Cleaning and Disinfection Instructions* on page 34. (See Fig. 11)

Fig. 10

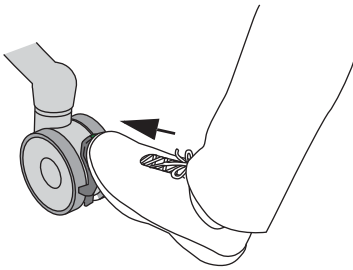

Fig. 11



Transfer from the Sling Lift

Fig. 1

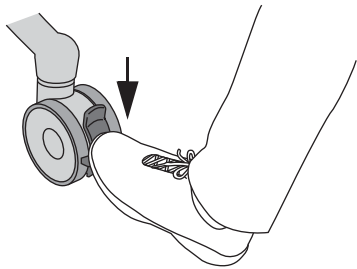
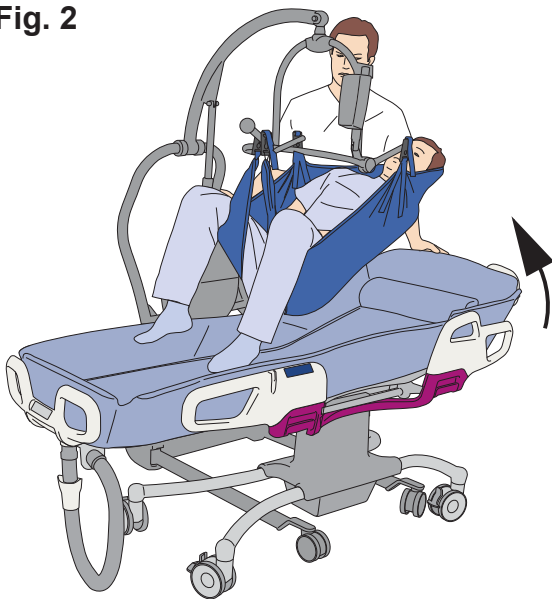

Fig. 2



Follow these 15 Steps

(For sling and lift instructions, see respective sling and lift *IFU*.)

- 1 Lower the *Carevo* shower trolley to lowest height.
- 2 Apply the castor brakes on the *Carevo* shower trolley. (See Fig. 1)
- 3 Make sure both the *Carevo* shower trolley side supports are folded up.
- 4 Raise the *Carevo* shower trolley adjustable back support, if available, to a more seated position for comfort and easier detachment of the sling. (See Fig. 2)
- 5 Place the head pillow in the *Carevo* shower trolley. (See Fig. 2)

6 **WARNING**

To avoid entrapment, make sure to keep the patient's hair, arms and feet close to the body and use designated grab supports during any movement.

WARNING

To avoid the patient from falling out of the device make sure that all side supports are in a locked position.

Lower the patient in the sling onto the *Carevo* shower trolley. Use the space under the *Carevo* shower trolley castor base for better positioning of the lift legs. (See Fig. 2)

NOTE

If the lift height is not enough to pass over the *Carevo* shower trolley, then fold down the side support on one side. Make sure to fold the side support back up afterwards.

Continue with the steps on the next page.

Fig. 3

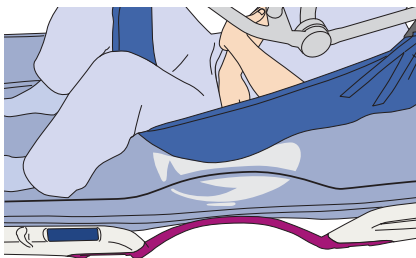

Fig. 4

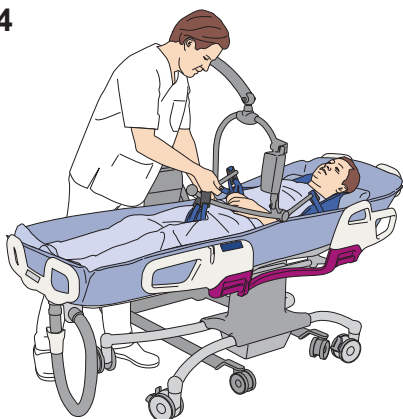

Fig. 5

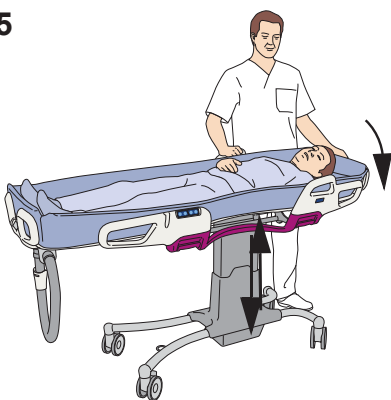
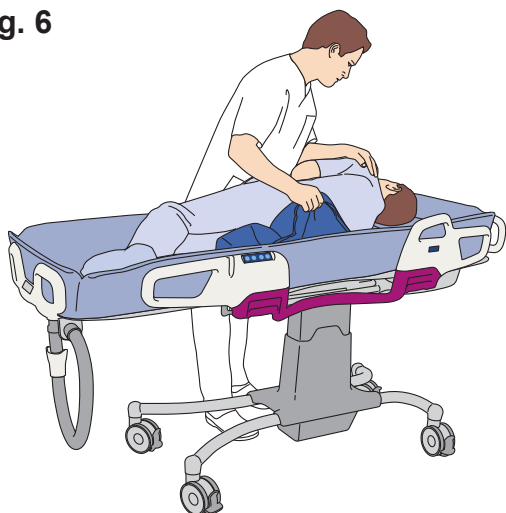

Fig. 6



7

WARNING

To make sure that the patient cannot slip out through the side support, make sure that the mattress sides are up and not folded underneath the patient.

For better comfort, position the patient correctly on the flexi zone. Make sure the patient's buttocks are within the graphic outline on the mattress. The patient's hip crease should be aligned with the illustrated human figure. (See Fig. 3)

8 Detach the sling from the spreader bar. (See Fig. 4)

9 Move the lift away from the *Carevo* shower trolley.

10 Adjust the *Carevo* shower trolley to an ergonomic height. (See Fig. 5)

11 Lower the *Carevo* shower trolley adjustable back support, if available. (See Fig. 5)

12 Remove the sling from underneath the patient. (Use local technique) (See Fig. 6)

13 Release the castor brakes on the *Carevo* shower trolley.

14 Raise the *Carevo* shower trolley adjustable back support, if available.

15 Transport the patient to the bath room.

Transfer to the Sling Lift

Fig. 1

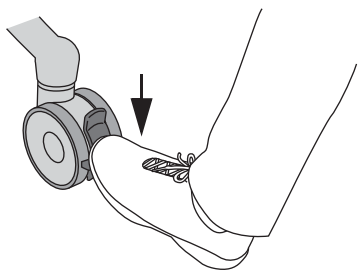

Follow these 10 Steps

(For sling and lift instructions, see respective sling and lift *IFU*.)

1 Apply all four castor brakes on the *Carevo* shower trolley. (See Fig. 1)

Fig. 2

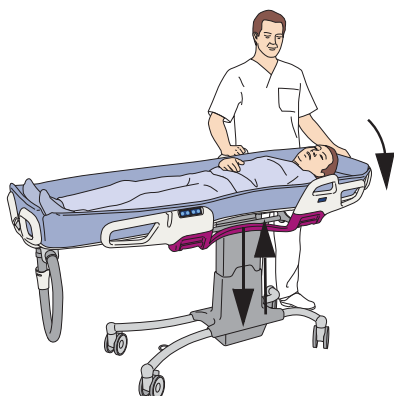

2 Adjust the *Carevo* shower trolley to an ergonomic height. (See Fig. 2)

3 Lower the *Carevo* shower trolley adjustable back support, if available. (See Fig. 2)

Fig. 3

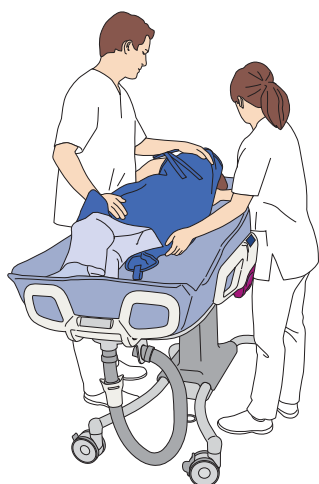

4 Apply the sling on the patient. (Use local technique). (See Fig. 3)

5 Lower the *Carevo* shower trolley to lowest height.

6 Raise the *Carevo* shower trolley adjustable back support, if available, for comfort and easier attachment of sling.

7 Position the lift's spreader bar over the *Carevo* shower trolley.

Fig. 4

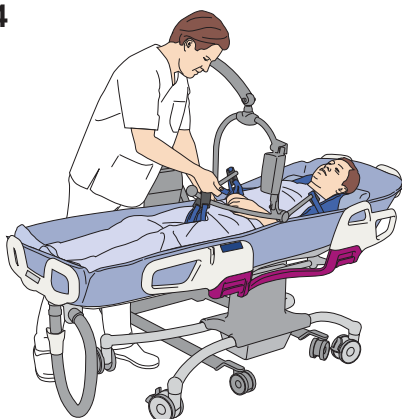

8 Attach the sling to the spreader bar. (See Fig. 4)

Continue with the steps on the next page.

Fig. 5

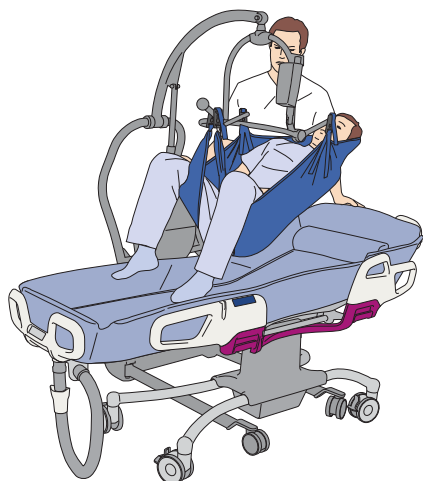

9 **WARNING**

To avoid entrapment make sure to keep the patient's hair, arms and feet close to the body and use designated grab supports during any movement.

WARNING

To avoid the patient from falling out of the device make sure that all side supports are in a locked position.

Lift the patient out of the *Carevo* shower trolley.
(See Fig. 5)

NOTE

If the height of the lift is not enough to go over the *Carevo* shower trolley, then fold down the side support on one side.

10 Disinfect the *Carevo* shower trolley. See section *Cleaning and Disinfection Instructions* on page 34. (See Fig. 6)

Fig. 6

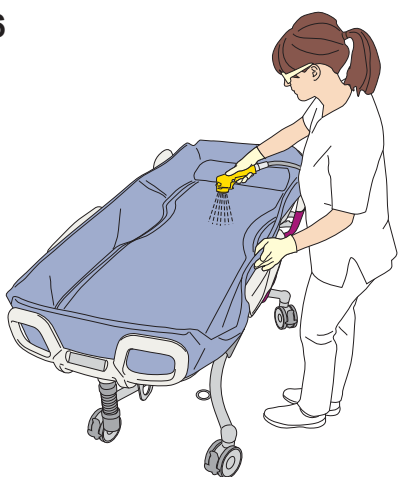

Shower the Patient

Fig. 1

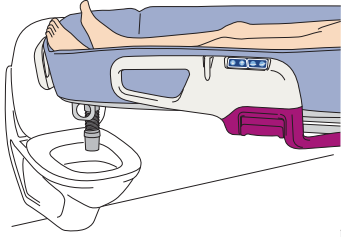

Follow these 13 Steps

For shower panel instructions, see respective shower panel *IFU*.

- 1 Position the *Carevo* shower trolley drainage over the toilet/flush sink or floor drain.

Toilet /Flush sink: Remove the *Carevo* shower trolley lower drainage and position the upper drainage over the toilet/flush sink. (See Fig. 1)

Floor Drain: Place the *Carevo* shower trolley lower drainage outlet in the drainage hose holder located on the castor base. Position the *Carevo* shower trolley so that the lower drainage outlet is right above the floor drain. (See Fig. 2)

- 2 Apply all four castor brakes on the *Carevo* shower trolley. (See Fig. 3)

- 3 Adjust the *Carevo* shower trolley to an ergonomic height.

- 4 Undress the patient. Use the adjustable back support, if available, for better assistance.

- 5 Set the water temperature.

6 **WARNING**

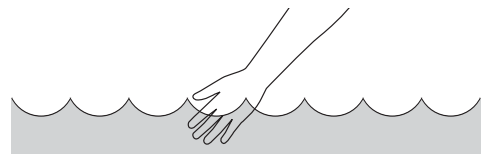

To prevent scalding, always check the water temperature with your naked hand before directing the water on the patient.

Do not use gloves as it may insulate to the extent that the water temperature can be misjudged. Point the flow of the water away from the patient.

First, grab the shower handle and direct it away from the patient. Then turn the water on. (See Fig. 4)

Fig. 2

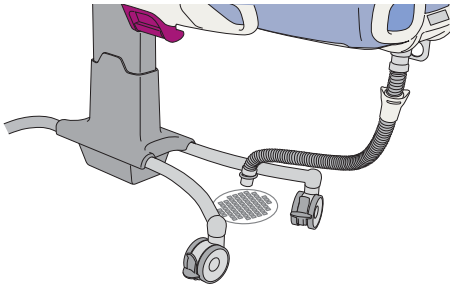

Fig. 3

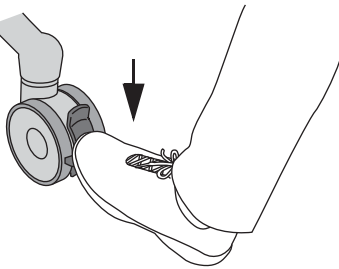
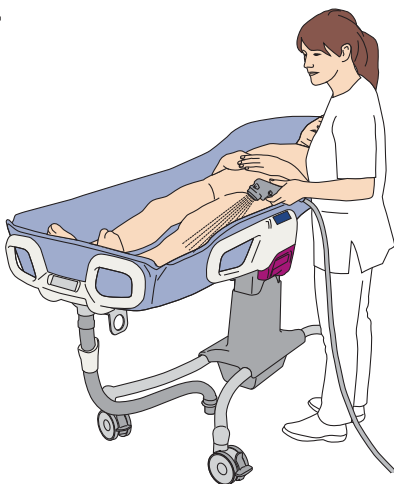
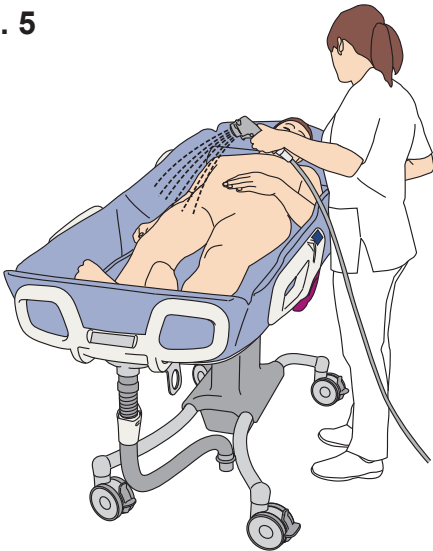

Fig. 4



Continue with the steps on the next page.

Fig. 5



7 Shower the patient. (See Fig. 5)

NOTE

Use the ergo-access area to better reach the patient. Remember to move around the Carevo shower trolley to avoid twisting and leaning forward when standing in the ergo-access area.

Fig. 6

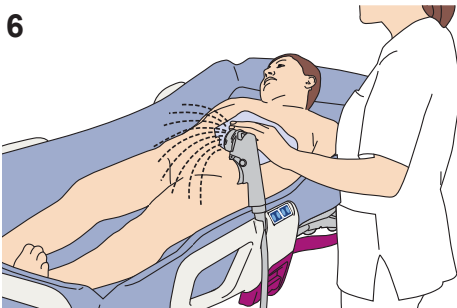

TIPS

Use the shower handle holder on the Carevo shower trolley for more effective work flow. Use it for sprinkling water over the patient, to keep him/her warm during the shower routine. (See Fig. 6)

Fig. 7

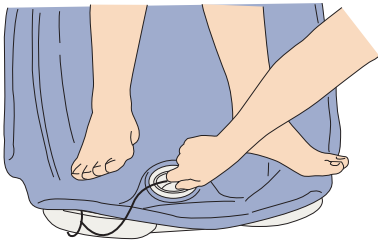

8 For shallow bathing, plug the mattress drain with the drainage plug. (See Fig. 7)

Fig. 8

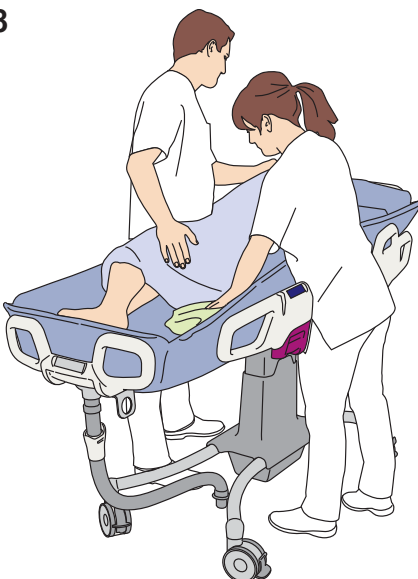

9 Drain the water and dry the patient and mattress. (See Fig. 8)

Continue with the steps on the next page.

Fig. 9

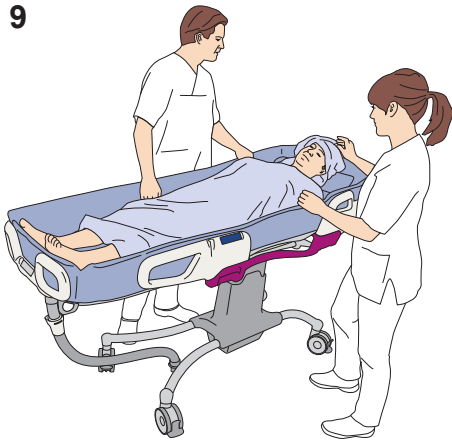

10 Cover or dress the patient to keep him/her warm.
(See Fig. 9)

Fig. 10

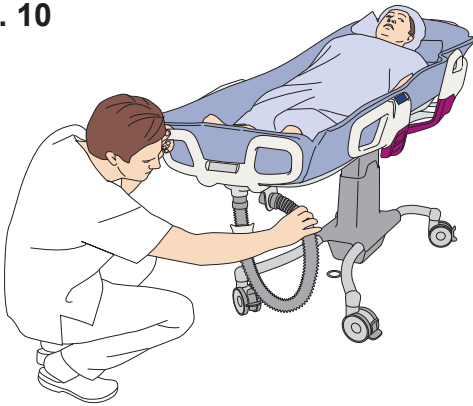

11 Place the lower drainage outlet back in the drainage hose holder under the foot panel or attach the lower drainage to the upper drainage. (See Fig. 10)

Fig. 11

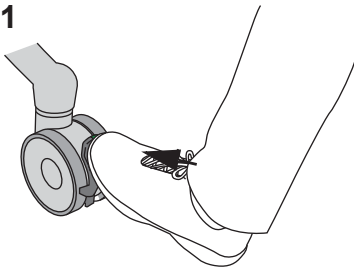

12 Release the castor brakes on the *Carevo* shower trolley.
(See Fig. 11)

Fig. 12

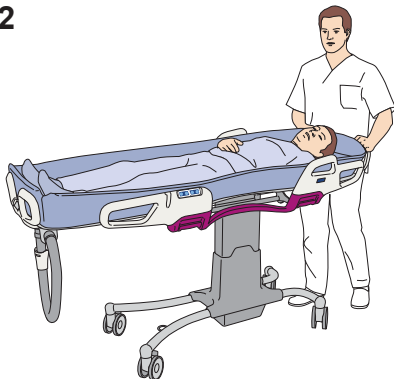

13 Transport the patient. (See Fig. 12)

Intentionally left blank

Home Care Use

For Distributors and Renters

When transporting the *Carevo* shower trolley to the customer with a van:

- Make sure the product is properly secured during transport.
- Avoid manoeuvring the shower trolley in dirty ground when transporting it to and from the van.

When delivering the *Carevo* shower trolley make sure that:

- You read this *IFU* together with the receiver (including relatives and caregivers).
- Show the features and intended usage described in the *IFU* with help of the real product.
- The user has understood the cleaning and disinfection instructions.
- Read all the warnings to the receiver.
- The environment fulfils all the requirements described in this *IFU*.

Cleaning and disinfection:

- Make sure that the cleaning and disinfection procedure described in this *IFU* always is carried out before the product reaches a new user.
- Make sure that the cleaning and disinfection procedure described in this *IFU* always is carried out before and after any type of service procedure.

Using the Shower Trolley

Before using the *Carevo* shower trolley in home environment make sure that: (See Fig. 1)

WARNING

To avoid the device from tipping and the patient from falling, do not use the equipment on floor with recessed drains, holes or slopes exceeding a ratio of 1:50 (1.15°).

- All caregivers, including relatives, have read and understood the instructions in this *IFU*.
- All carpets and rugs in the environment are removed.
- All thresholds in the environment are removed.
- All stairs and edges have a fence and safety gate to prevent the shower trolley from rolling down.
- There is room enough in the care environment for use of the shower trolley.

During Storage of the *Carevo* shower trolley make sure that:

WARNING

To avoid strangulation, make sure to never leave children unattended near the equipment.

- No children can access the shower trolley.
- No pets can come in contact with the shower trolley.
- The storage environment fulfils the requirements according to *Technical Specifications on page 44*.

Fig. 1

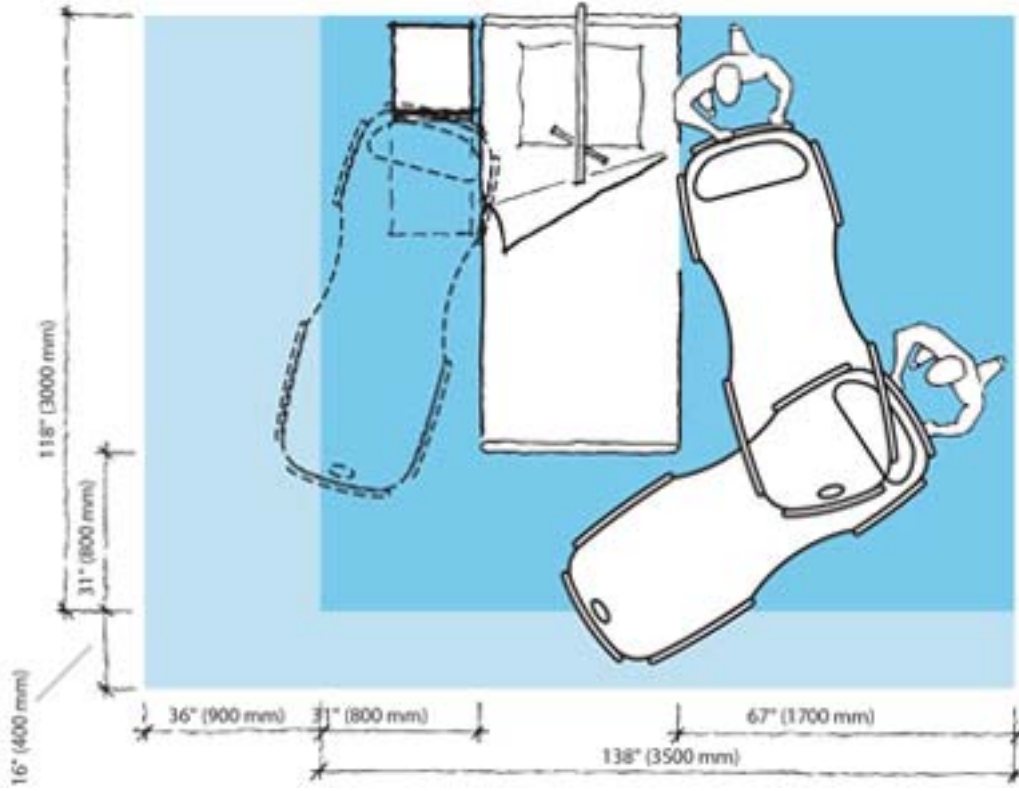

Cleaning and Disinfection Instructions

Only use Arjo Branded Disinfectant Cleansers (e.g. Arjo Clean™).

If you have any questions regarding disinfecting the Carevo shower trolley, or wish to order disinfectant, contact Arjo Customer Service. See section *Parts and Accessories* on page 54.

Make sure to have the Material Safety Data Sheets (MSDS) available for the disinfectant being used.

WARNING

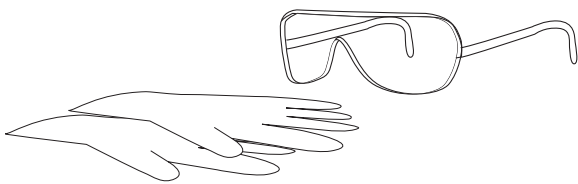

To avoid eye and skin damage, always use protective glasses and gloves. If contact occurs rinse with plenty of water. If eyes or skin becomes irritated, contact a physician. Always read the IFU and the Material Safety Data Sheet (MSDS) of the disinfectant.

WARNING

To prevent cross-contamination, always follow the disinfection instructions in this IFU.

WARNING

To avoid eye and skin irritation, never disinfect in the presence of a patient.

CAUTION

To avoid damage on the equipment only use Arjo branded disinfectants. Chlorine will bleach the mattress.

Allowed Disinfectants

- Arjo Clean
- Arjo General Purpose Disinfectant
- Arjo Disinfectant Cleanser IV
- Arjo All Purpose Disinfectant
- Arjo CenKleen IV

Accessories for Disinfecting the Carevo Shower Trolley

- Protective glasses
- Protective gloves
- Spray bottle (if a shower panel is not available)
- Disinfectant fluid
- Disposable towels
- Soft bristle cleaning brush
- Bottle brush

Always Follow these 24 Steps for Proper Cleaning and Disinfection

If an Arjo shower panel will be used, see respective *IFU*.

Mechanical cleaning (Step 1- 8 of 24)

- 1 Put on protective gloves and eye wear. (See Fig. 1)
- 2 Make sure the disinfectant is mixed according to the instructions on the disinfectant bottle label or according to the mix ratio stated in the shower panel *IFU*. (See Fig. 2)
- 3 Remove the lower drainage and the pillow.
- 4 Rinse the *Carevo* shower trolley with water. Start from the top of the mattress down towards the castors. (See Fig. 3)
- 5 Scrub the *Carevo* shower trolley with disinfectant using a soft bristle cleaning brush to remove contamination. Start from the top of the mattress moving down towards the castors.
- 6 Use a bottle brush soaked in disinfectant to clean the upper drainage.
- 7 Remember to clean the underside of mattress, support plates and outside of the upper drainage.
- 8 Using a soft bristle cleaning brush, scrub the pillow and the lower drainage separately. Avoid contact with the mattress until the pillow has been disinfected.

Fig. 1



Fig. 2

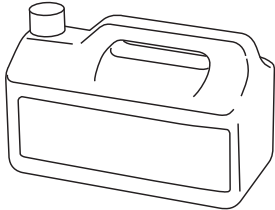
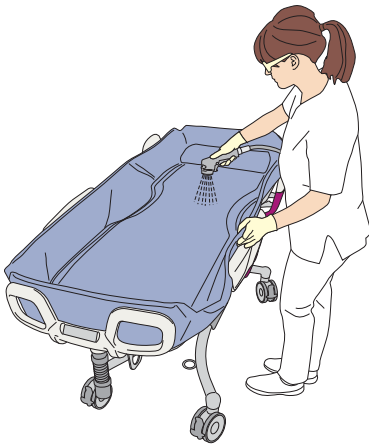

Fig. 3



Continue with the steps on the next page.

Fig. 4

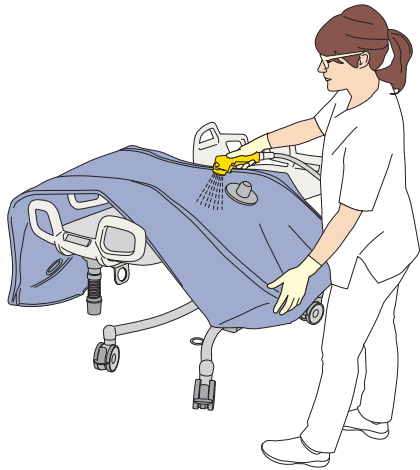

Fig. 5



Fig. 6

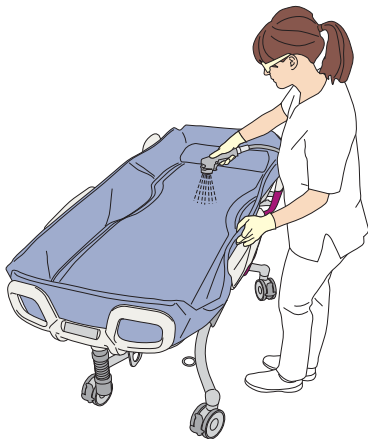

Fig. 7



Disinfecting (step 9-24)

- 9 Lift up and place the mattress over the foot panel and side supports. The backside of the mattress should be facing up.
- 10 Spray disinfectant and clean the backside of the mattress with a disposable towel. **(See Fig. 4 and 5)**
- 11 Spray disinfectant and clean the following parts on the *Carevo* shower trolley head end: head panel, side supports, support plate and flexi zone with a disposable towel.
- 12 Place the disinfected backside of the mattress over the disinfected head panel and side supports. The inside of the mattress that has not been disinfected should now be facing up.
- 13 Push out the mattress corner creases.
- 14 Spray disinfectant and clean the mattress that is facing up (inside) with a disposable towel.
- 15 Push in the mattress corner creases.
- 16 Spray disinfectant and clean the following parts on the *Carevo* shower trolley foot end: foot panel, side supports, support plate, flexi zone and upper drainage with a disposable towel.
- 17 Spray disinfectant on the upper drainage and clean it with a bottle brush.
- 18 Place the mattress in its original position.
- 19 Spray disinfectant and clean the outside of the *Carevo* shower trolley with a disposable towel. Start from the top of the mattress moving down towards the castors.
- 20 Allow a disinfection time according to the instructions on the disinfectant bottle label.
- 21 Spray disinfectant and clean the pillow and the lower drainage separately with a disposable towel.
- 22 Attach the lower drainage to the upper drainage and place the pillow on the mattress.
- 23 Rinse all parts thoroughly with cold water until there are no visible traces of the disinfectant. Start from the top of the mattress moving down towards the castors. Remember to rinse underneath the mattress as well. **(See Fig. 6)**
- 24 Wipe dry each part of the *Carevo* shower trolley using disposable towels. Make sure the *Carevo* shower trolley is completely dry. **(See Fig. 7)**

Intentionally left blank

Battery Instructions

WARNING

To avoid bodily injury, do NOT crush, puncture, open, dismantle or otherwise mechanically interfere with the battery.

- Should the battery casing crack and cause contents to come in contact with skin or clothing, rinse immediately with plenty of water.
- If contents come in contact with the eyes, rinse immediately with plenty of water and seek medical attention.
- Inhalation of the contents can cause respiratory irritation. Provide fresh air and medical attention.

CAUTION

To avoid the battery from overheating and exploding, do NOT expose the battery to flames or excessive heat.

- Be careful not to drop the battery.
- Contact the appropriate local authority for advice when disposing of batteries.
- For battery label, see section *Labels on page 48*.

Storage of Batteries

- The battery is delivered charged but we recommend you recharge the battery when received due to a slow self discharge.
- This battery will slowly self discharge when not used.
- A battery not in use should be stored in a temperature range of -0 °C (32 °F) to + 30 °C (86 °F).
- For maximum battery performance do not store the battery above 50 °C (122 °F).

Charging Intervals

- To prolong the life of the battery, charge it at regular intervals, i.e. every night.
- If the *Carevo* shower trolley is used frequently, it is recommended to use two batteries, one in operation and one as a stand-by in the charger.
- It is recommended that a battery not in use is left in the charger. There is no risk of overcharging the battery.

Battery Service Life

Make sure to always have two well functional batteries, one to use and one in storage.

If using a freshly charged battery and the battery indicator starts to flash and sound after only a few activities are carried out, it is time to order a new battery.

Low Charge Warning

A buzzer sound will go off when the battery reaches a low charge. The battery should then be recharged as soon as possible.

Installation of Charger

See *NEA 8000 Battery Charger IFU*.

How to Charge the Battery

See *NEA 8000 Battery Charger IFU*.

Care and Preventive Maintenance

Caregiver Obligations

The *Carevo* shower trolley is subject to wear and tear, and the following actions must be performed when specified to make sure that the product remains within its original manufacturing specification.

WARNING

To avoid malfunction resulting in injury, make sure to conduct regular inspections and follow the recommended maintenance schedule. In some cases due to heavy use of the product and exposure to aggressive environment more frequent inspections should be carried out. Local regulations and standards may be more stringent than the recommended maintenance schedule.

NOTE

Product cannot be maintained and serviced while in use with the patient.

PREVENTIVE MAINTENANCE SCHEDULE

CAREGIVER OBLIGATIONS Action/Check	Every USE	Every WEEK	Every YEAR
Clean/Disinfect	X		
Visually check all exposed parts		X	
Visually check mechanical attachments		X	
Perform functionality test		X	
Inspect castors		X	
Visually check battery		X	
Check mattress and head pillow		X	
Yearly checks by qualified personnel only			X

WARNING

To avoid injury to both patient and caregiver, never modify the equipment or use incompatible parts.

Fig. 1

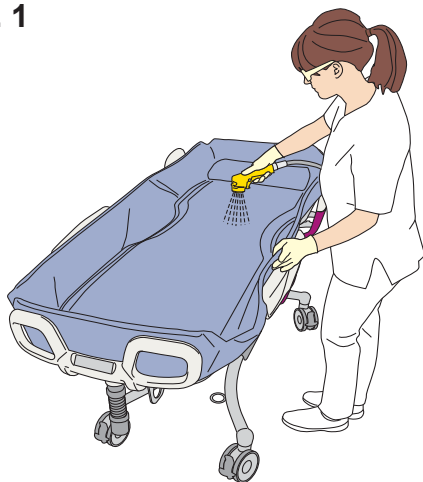

Caregiver Obligations

Every Use

Clean/Disinfect

- The *Carevo* shower trolley has to be cleaned and disinfected immediately after usage. **(See Fig. 1)**
- For further disinfecting instructions see section *Cleaning and Disinfection Instructions* on page 34.

Every Week

Visually check all exposed parts

- Check especially where personal contact is made by either the patient or caregiver.
- Make sure no cracks or sharp edges have developed that could cause the patient or caregiver injury or that has become unhygienic causing cross-contamination. **(See Fig. 2)**
- Check the drainage hose with all parts.
- Check for corrosion.
- Check cables for damage e.g. cuts and tears.
- Replace damaged parts or contact qualified personnel.

Check mechanical attachments

- Check the two screws on both sides of the opening handles.
- Check the attachment of the pillar, both upper and lower attachment. **(See Fig. 2)**

Perform functionality test (See Fig. 3)

- Check opening handles on the side supports and that they lock properly.
- Check the adjustable back support, if available.
- Check the raising and lowering of the *Carevo* shower trolley.
- Check the castors, brakes and straight steering devices. (see below).

Inspect castors

- Clean the castors with water (the function can be affected by soap, hair, dust and chemicals from floor cleaning).
- Check the brakes and straight steering devices.
- Check that the castors are rolling and swivelling freely. **(See Fig. 4)**

Fig. 2

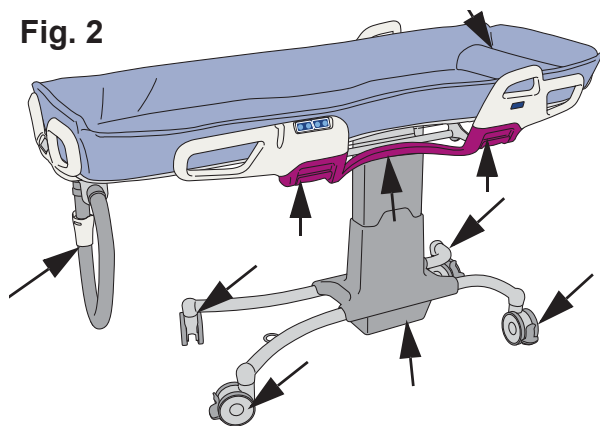

Fig. 3

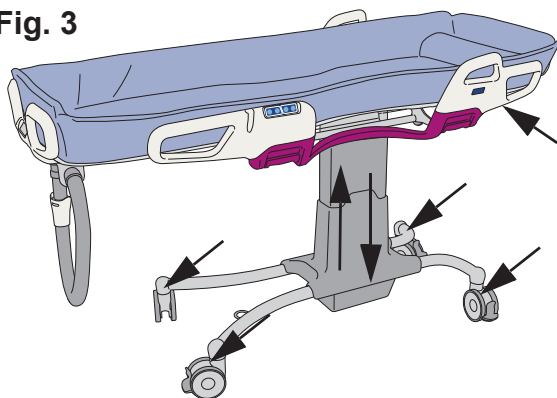
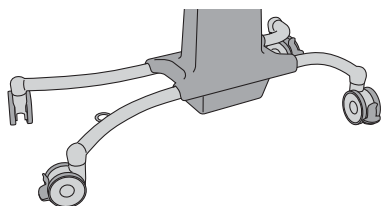
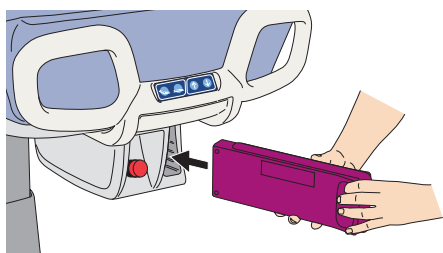

Fig. 4



Continue with the steps on the next page.

Fig. 5



Visually check battery

- Visually check the condition of the battery. Remove and replace immediately if damaged. **(See Fig. 5)**

Fig. 6

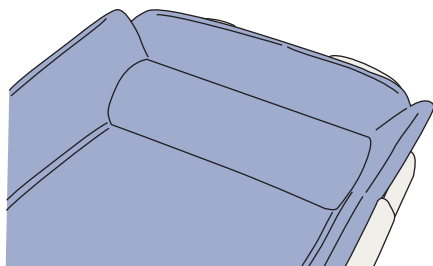

Check the mattress and head pillow

- Make sure there are no cracks or tears that would allow water to get into the filling. If there is such damage, replace damaged parts to avoid cross-infection. **(See Fig. 6)**

Yearly Checks by Qualified Personnel only

The *Carevo* shower trolley must be serviced once a year in accordance with the *Maintenance and Repair Manual*.

WARNING

To avoid injury and/or unsafe product, the maintenance activities must be carried out at the correct frequency by qualified personnel using correct tools, parts and knowledge of procedures. Qualified personnel must have documented training in maintenance of this device.

NOTE

All Caregiver Obligations are to be checked when performing the Qualified Personnel Service. For details, see separate service instructions.

Alarms and Sounds

ALARM	ACTION
A short buzzer sound is heard when pressing a button on the control panel.	The battery level is low. Complete the current workflow and change to a fully charged battery.
A pulsing buzzer sound is heard for 10 seconds.	The battery needs to be charged and the <i>Carevo</i> shower trolley can only be lowered (not raised). Change to a fully charged battery.
Only a few activities are carried out before the battery indicator will flash and sound.	Replace the battery with a fully charged one. If using a freshly charged battery and the battery indicator starts to flash and sound after only a few activities are carried out, it is time to order a new battery.
The <i>Carevo</i> shower trolley makes abnormal sounds during use.	<ol style="list-style-type: none"><li data-bbox="737 710 1369 745">1 Remove the patient and make a visual check.<li data-bbox="737 768 1150 804">2 Contact qualified personnel.

Troubleshooting

WARNING

To avoid injury, make sure that the patient is not left unattended at any time.

PROBLEM	ACTION
Electrical movement of the <i>Carevo</i> shower trolley and adjustable back support (if available) continues after releasing the control buttons.	<ol style="list-style-type: none"> 1 Activate the emergency stop button. 2 Remove the patient from the <i>Carevo</i> shower trolley and contact qualified personnel.
Electrical movement of the <i>Carevo</i> shower trolley and adjustable back support does not work when pressing the control buttons.	<ol style="list-style-type: none"> 1 Make sure that the <i>Carevo</i> shower trolley movements are not blocked (by a bed or something nearby the <i>Carevo</i> shower trolley). 2 Press the button on a different control panel. If that works, contact qualified personnel to replace the damaged control panel. 3 Make sure that the emergency stop button is inactivated. To inactivate turn the emergency stop button clockwise. 4 Check that the battery is correctly inserted in the battery compartment. 5 Make sure the battery is charged. 6 Contact qualified personnel.
The opening handles will not lock.	<ol style="list-style-type: none"> 1 Remove the patient and make a visual check. 2 Contact qualified personnel.
The <i>Carevo</i> shower trolley is hard to manoeuvre during transport.	<ol style="list-style-type: none"> 1 Make sure that all the brakes and straight steering devices are released. 2 Remove the patient from the <i>Carevo</i> shower trolley and check that all the castors swivel and roll freely. 3 Contact qualified personnel.
It is only possible to lower the lift.	Lower device to a safe position. Stop using the equipment and contact authorized service personnel.

NOTE

If the problem can not be solved with the written troubleshooting actions, please contact qualified personnel.

Technical Specifications

General	
Safe working load (SWL) = Maximum total load (Patient + Water)	200 kg (440 lbs)
Maximum patient weight	182 kg (400 lbs)
Weight of the Carevo shower trolley (<i>without patient and water</i>)	82 kg (181 lbs)
Model and Type	Standard: BAC1101-01(Europe & North America), BAC1102-01 (Japan) BAC1103-01(Australian) With adjustable back rest: BAC1111-01(Europe & North America), BAC1112-01(Japan) BAC1113-01(Australian)
Degree of protection	IP24 IP: Ingress Protection 2: Protection against insertion of fingers or similar objects. 4: Water splashing against the product from any direction does not effect safety or essential performance
Medical equipment	Type BF 
Operating forces: Control buttons	5 N
Brake	70 N (Activate) 50 N (Release)
Straight steering	20 N (Activate) 20 N (Release)
Emergency stop button	25 N
Opening handles	30 N
Lift nominal voltage	24 VDC
Battery part number	NEA0100-083
Battery type	NiMH (Nickel-metal hydride)
Battery capacity	2.5 Ah
Battery voltage	24 V DC
Battery Charger part number	NEA 8000
Maximum duty cycle: ED (The ratio of a device operating time versus cooling time)	Lift actuator 2 minutes ON, 18 minutes OFF Adjustable back support 2 minutes ON, 18 minutes OFF
Sound Level	50 dB (A)
Pollution degree	2
Motor power: Lift (raise/lower)	216 VA
Motor power: Adjustable back rest	72 VA
Allowed water temperature on mattress	+10° C to +60 °C (+50 °F to +140 °F)
Degree of fire protection	According to standard EN 1021-1 and EN1021-2.

Allowed Combination

<p>The Carevo shower trolley integrates with the following products.</p>	<p>Arjo shower equipment: Shower panel (BCA), Sink (BDA), Flush Sink (BDA) and Shower Hose (PP0998)</p> <p>Arjo lifts: Maxi Twin, Maxi Twin Compact, Maxi Move, Minstrel, Maxi 500, Maxi Sky 440, Maxi Sky 2 and Maxi Sky 600</p> <p>Arjo sliding sheets: MaxiSlide, MaxiSlide Flites and MaxiOnce</p> <p>Beds: The bed must be equipped with brakes and be possible set at a height higher than 600 mm (25 5/8”) (measured from floor to mattress surface). The bed must be of such design that enables an even surface to slide over without a gap. If a gap exists a suitable bridge must be used.</p> <p>Toilets: The Carevo shower trolley can be used over all standard toilets regardless of whether the toilet is attached to the wall or to the floor.</p>
--	--

No other combinations are allowed

Operating, transport and storage

Temperature	<p>+10 °C to + 40 °C (+50 °F to +104 °F) Operating</p> <p>-20 °C to +70 °C (-4 °F to +158 °F) Transport</p> <p>-20 °C to +70 °C (-4 °F to 158 °F) Storage</p>
Humidity	<p>15-95% at +20 °C (+68 °F) Operating</p> <p>10-80% at +20 °C (+68 °F) Transport</p> <p>10-80% at +20 °C (+68 °F) Storage</p>
Atmospheric pressure	<p>800 hPa to 1060 hPa Operating</p> <p>500 hPa to 1100 hPa Transport</p> <p>500 hPa to 1100 hPa Storage</p>

Recycling

Package	Wood and corrugated cardboard, Recyclable
---------	---

End of Life Disposal

- All batteries in the product must be recycled separately. Batteries are to be disposed in accordance with national or local regulations.
- Slings including stiffeners/stabilizers, padding material, any other textiles or polymers or plastic materials etc. should be sorted as combustible waste.
- Lift systems having electrical and electronic components or an electrical cord should be disassembled and recycled per Waste of Electrical and Electronic Equipment (WEEE) or in accordance with local or national regulation.
- Components that are primarily be made up of different kinds of metal (containing more than 90% metal by weight) for example sling bars, rails, upright supports, etc., should be recycled as metals.

Dimensions

Measurements in mm and in inches (")

Highest position

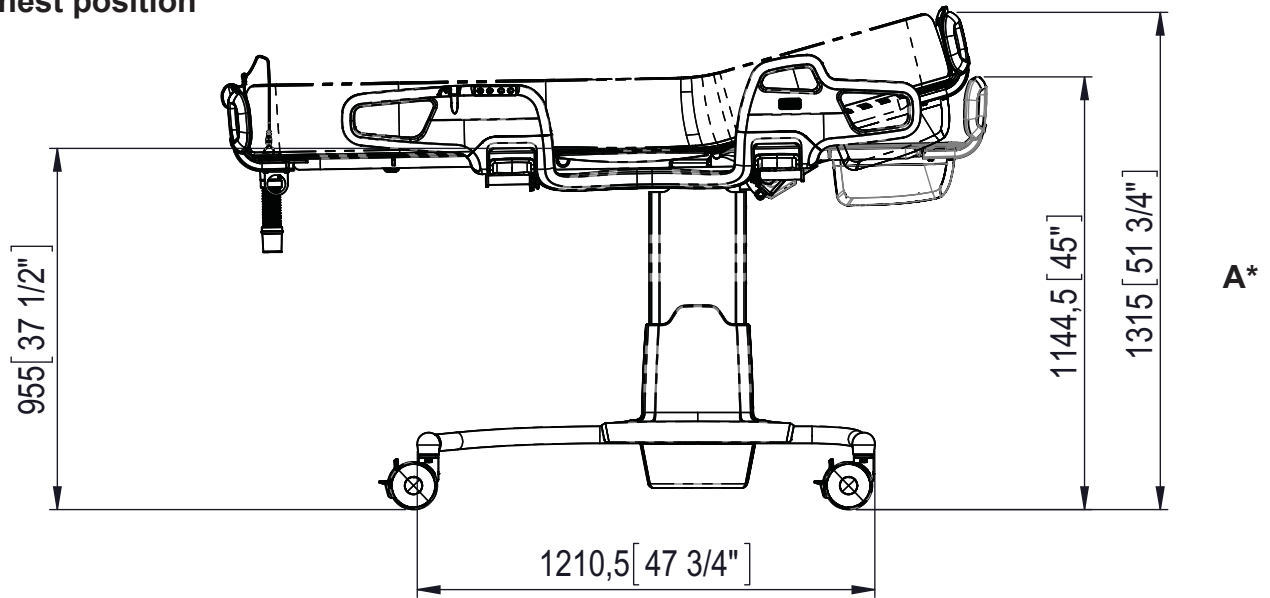

Lowest position

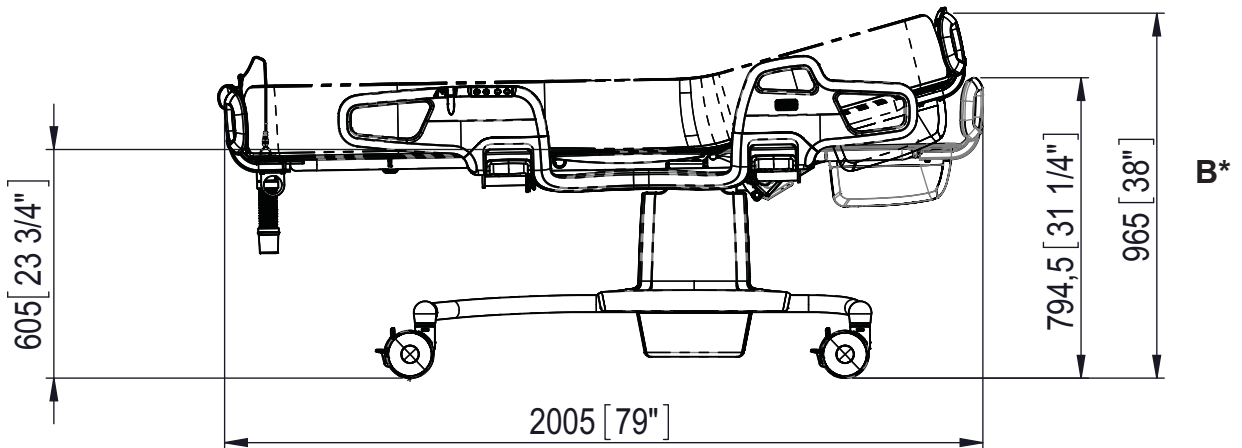

* Stroke between the highest (A) and the lowest (B) position is 350 mm (13 3/4")

Measurements in mm and in inches (")

Foot end view

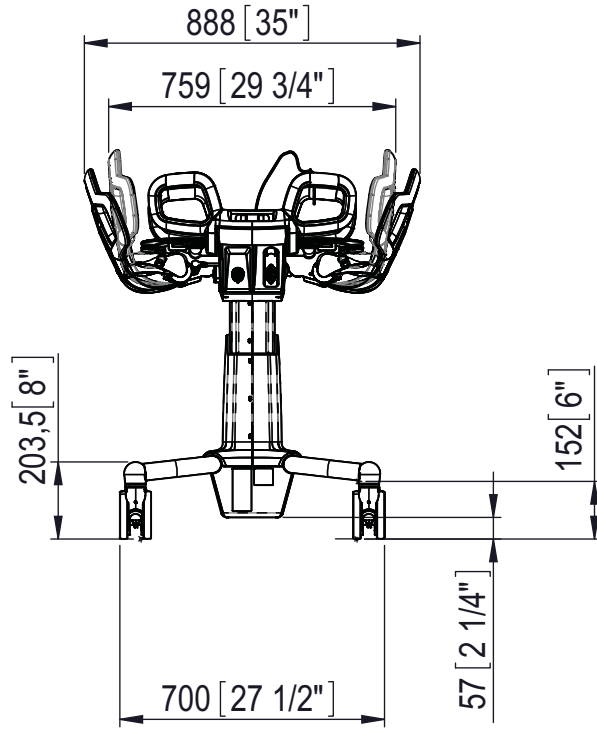

Turning radius

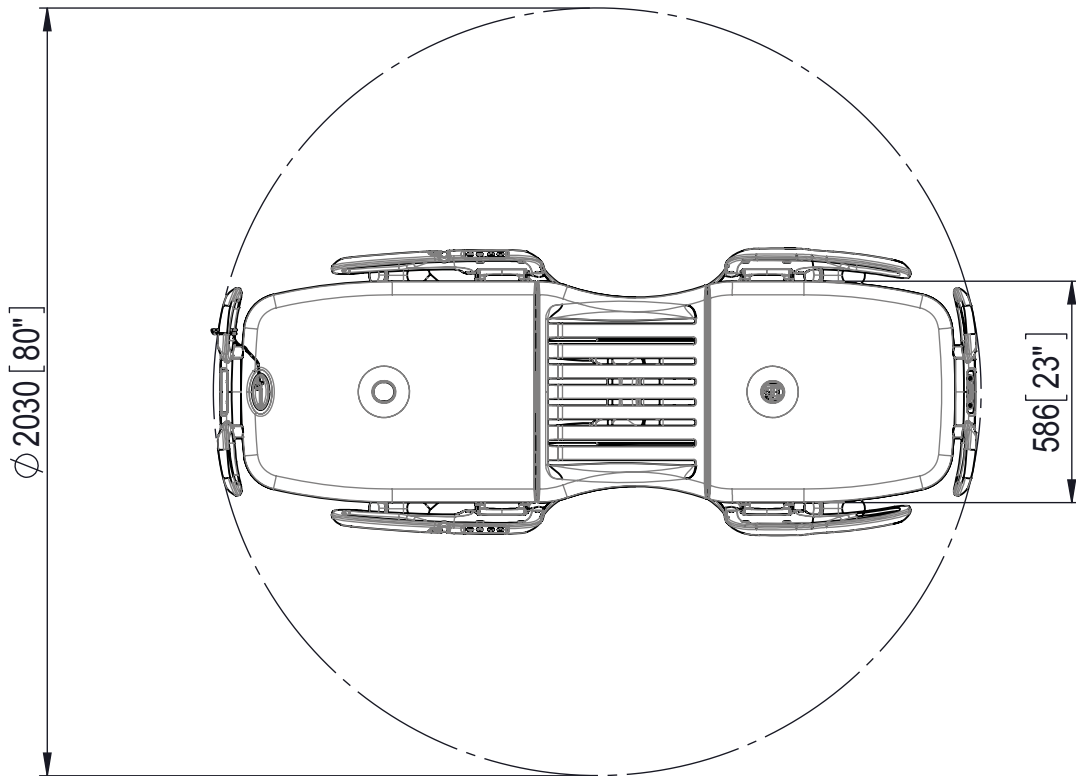









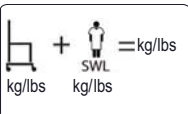





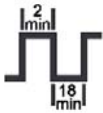

Labels

Label explanation

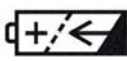
Battery Label	States safety and environmental information for the battery.
Data Label	States technical performance and requirements, e.g. Input Power, Input Voltage and maximum Patient Weight etc.
Identification Label	States the product identification, serial number and year and month of manufacturing.

Symbol explanation

Max total load	Defines the maximum total load of patient, water or any other load that may be on the lift.
Max patient weight	Defines the maximum weight of the patient.
	Total mass of equipment including its safe working load.
IP24	Degree of protection (i.e. the product is protected against insertion of fingers and splashing water)
216 W	Maximum motor power
24 V DC	Supply voltage
2.5 Ah	Capacity
	Type BF, Applied part: protection against electrical shock in accordance with IEC 60601-1.
	Read the <i>IFU</i> before use
	Manufacturing date
	Separate electrical and electronic components for recycling in accordance with the European Directive 2012/19/EU (WEEE)

	Emergency stop label
	Mode of operation (ED) Adjustable back support - Duty Cycle 2 minutes ON, 18 minutes OFF Lift - Duty Cycle 2 minutes ON, 18 minutes OFF
	CE marking indicating conformity with European Community harmonised legislation.
	Indicates the product is a Medical Device according to EU Medical Device Regulation 2017/745.
	A battery is the power source of this equipment.
	Type of battery to be used. (rechargeable)
	Lift stroke
	The shower trolley has been safety tested in accordance with <i>List of Standards and Certificates on page 50.</i>
	Environmental danger. Not for disposal.
	Recyclable
	The name and address of the manufacturer.
	Model number

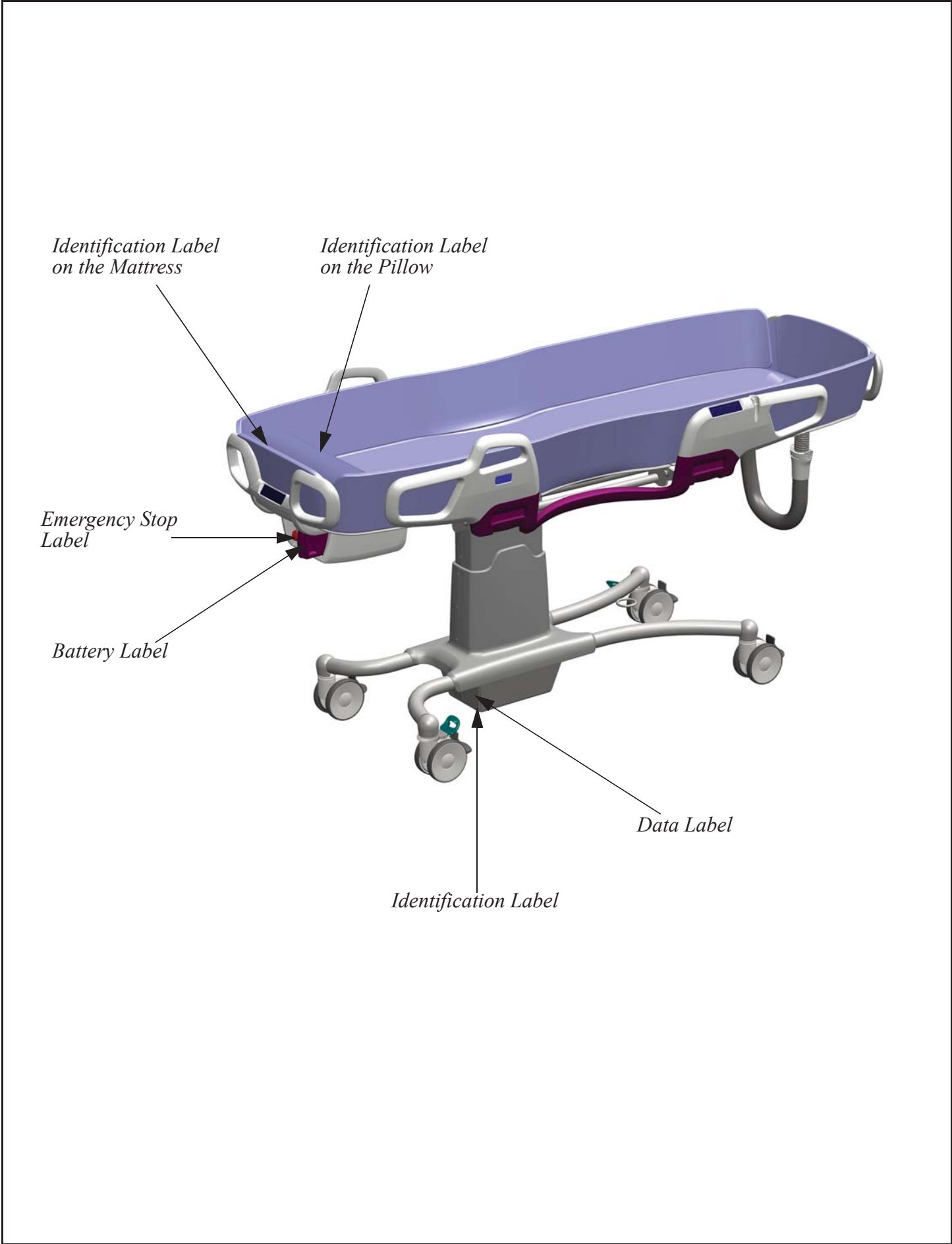

List of Standards and Certificates

CERTIFICATE	STANDARDS
EN/IEC 60601-1:2005 AMD1:2012	Medical Electrical Equipment - Part 1: General Requirements for Basic Safety and Essential Performance
ANSI/AAMI ES60601-1 (2005) AMD 1 (2012)	Medical Electrical Equipment - Part 1: General Requirements for Basic Safety and Essential Performance
CAN/CSA-C22.2 No. 60601-1:14	Medical Electrical Equipment - Part 1: General Requirements for Basic Safety and Essential Performance
ISO 10535:2006	Hoists for the transfer of disabled persons -- Requirements and test methods
EN/IEC 60601-1- 11:2015	Requirements for medical electrical equipment and medical electrical systems used in the home healthcare environment

Intentionally left blank

Electromagnetic compatibility

Product has been tested for compliance with current regulatory standards regarding its capacity to block EMI (electromagnetic interference) from external sources.

Some procedures can help reduce electromagnetic interferences:

- Use only Arjo cables and spare parts to avoid increased emissions or decreased immunity which can compromise the correct functioning of the equipment.
- Ensure that other devices in patient-monitoring and/or life-support areas comply to accepted emissions standards.

WARNING

Wireless communications equipment such as wireless computer network devices, mobile phones, cordless telephones and their base stations, walkie-talkies, etc. can affect this equipment and should be kept at least 1.5m away from the equipment.

Intended Environment: Home Healthcare Environment and Professional Healthcare facility environment.

Exceptions: HF Surgical Equipment and the RF Shielded room of an ME SYSTEM for magnetic resonance imaging

WARNING

Use of this equipment adjacent to or stacked with other equipment should be avoided because it could result in improper operation. If such use is necessary, this equipment and the other equipment should be observed to verify that they are operating normally.

Guidance and manufacturer's declaration – electromagnetic emission		
Emission test	Compliance	Guidance
RF emissions CISPR 11	Group 1	This equipment uses RF energy only for its internal functions. Therefore its RF emissions are very low and are not likely to cause any interference in nearby electronic equipment.
RF emissions CISPR 11	Class B	This equipment is suitable for use in all establishments, including domestic establishments and those directly connected to the public low voltage power supply network that supplies buildings used for domestic purposes.

Guidance and manufacturer's declaration – electromagnetic immunity			
Immunity test	IEC 60601-1-2 test level	Compliance level	Electromagnetic environment – guidance
Electrostatic discharge (ESD) EN 61000-4-2	±2kV, ±4kV, ±8kV, ±15kV air ±8kV contact	±2kV, ±4kV, ±8kV, ±15kV air ±8kV contact	Floors should be wood, concrete or ceramic tile. If floors are covered with synthetic material the relative humidity level should be at least 30%.
Conducted disturbances induced by RF fields EN 61000-4-6	3V in 0,15 MHz to 80 MHz 6V in ISM and amateur radio bands between 0,15 MHz and 80 MHz 80% AM at 1 kHz	Not applicable	Portable and mobile RF communications equipment should be used no closer to any part of the product, including cables, than 1.0m, if the transmitter's output power rating exceeds 1W ^a . Field strengths from fixed RF transmitters, as determined by an electromagnetic site survey, should be less than the compliance level in each frequency range ^b . Interference may occur in the vicinity of equipment marked with this symbol: 
Radiated RF electromagnetic field EN 61000-4-3	Home Healthcare environment 10 V/m 80 MHz to 2,7 GHz 80% AM at 1 kHz	Home Healthcare environment 10 V/m 80 MHz to 2,7 GHz 80% AM at 1 kHz	
Proximity fields from RF wireless communications equipment EN 61000-4-3	385 MHz - 27 V/m 450 MHz - 28 V/m 710, 745, 780 MHz - 9V/m 810, 870, 930 MHz - 28 V/m 1720, 1845, 1970, 2450 MHz – 28 V/m 5240,5500, 5785 MHz - 9V/m	385 MHz - 27 V/m 450 MHz - 28 V/m 710, 745, 780 MHz - 9V/m 810, 870, 930 MHz - 28 V/m 1720, 1845, 1970, 2450 MHz - 28 V/m 5240,5500, 5785 MHz - 9V/m	
Electrical fast transient/burst EN 61000-4-4	±1kV SIP/SOP ports 100 kHz repetition frequency	Not applicable	
Power frequency Magnetic field EN 61000-4-8	30 A/m 50 Hz or 60 Hz	30 A/m 50 Hz	Power frequency magnetic fields should be at levels characteristic of a typical location in a typical commercial or hospital environment.
<p>^a Field strengths from fixed transmitters, such as base stations for radio (cellular/cordless) telephones and land mobile radios, amateur radio, AM and FM radio broadcast and TV broadcast cannot be predicted theoretically with accuracy. To assess the electromagnetic environment due to fixed RF transmitters, an electromagnetic site survey should be considered. If the measured field strength in the location in which the product is used exceeds the applicable RF compliance level above, the product should be observed to verify normal operation. If abnormal performance is observed, additional measures may be necessary.</p> <p>^b Over the frequency range 150 kHz to 80 MHz, field strengths should be less than 1 V/m.</p>			

Parts and Accessories

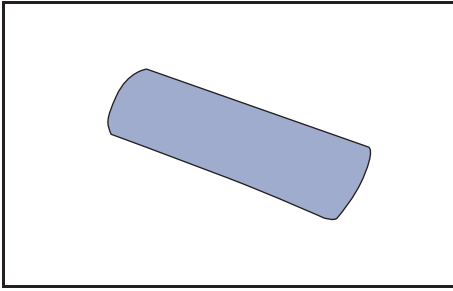

Head Pillow
8663465-017

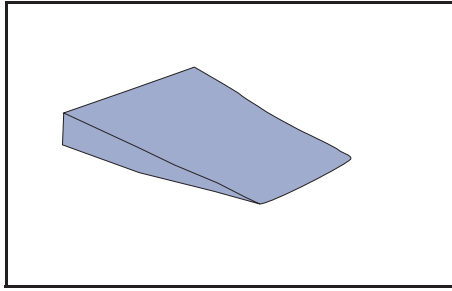

Wedged pillow
100880-01



Mattress
8663449-017

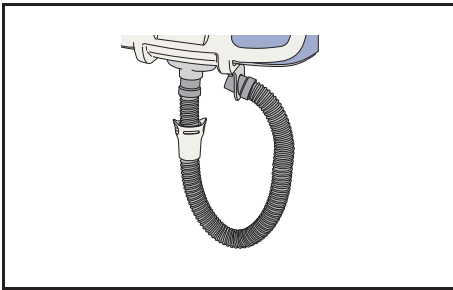

Drainage Hose
Length 1000 mm (39 3/8"):
8564162-1000
Length 1500 mm (59"):
8564162-1500
Length 2000 mm (78 3/4"):
8564162-2000

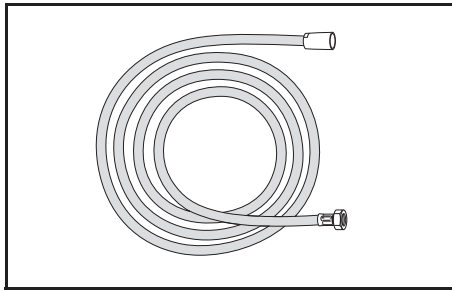

Shower Hose
PP0998

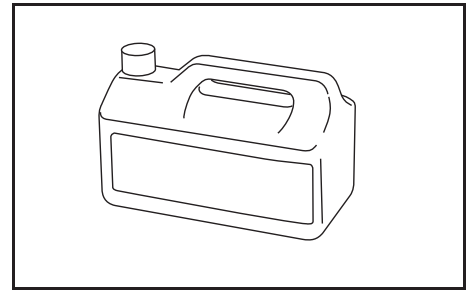

For disinfectant contact the
local Arjo representative

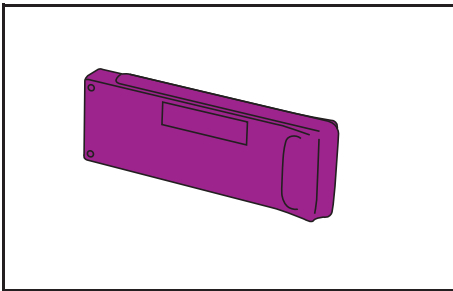

Battery
NEA0100-083

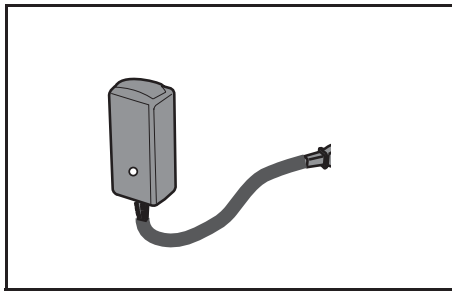

Battery charger
NEA 8000

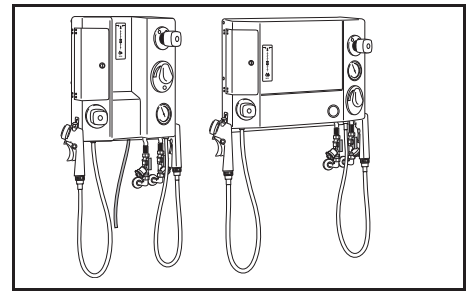

Shower Panel (BCA)
1207/1204/1202/1201-04
1217/1214/1212/1211-04
1227/1224/1222/1221-04

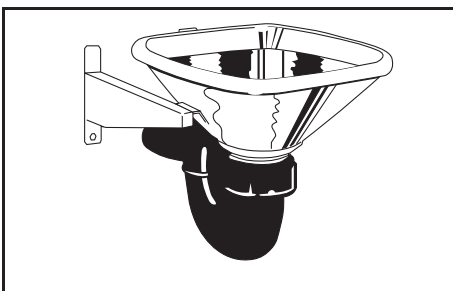

Sink
BDA0815/0816-90

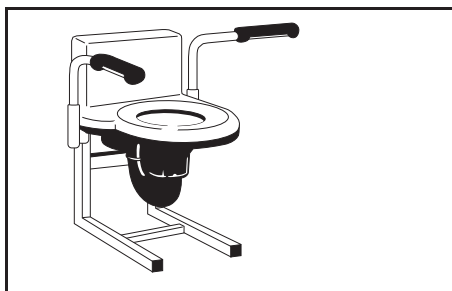

Flush sink
BDA 0891-04

At Arjo, we are committed to improving the everyday lives of people affected by reduced mobility and age-related health challenges. With products and solutions that ensure ergonomic patient handling, personal hygiene, disinfection, diagnostics, and the effective prevention of pressure ulcers and venous thromboembolism, we help professionals across care environments to continually raise the standard of safe and dignified care. Everything we do, we do with people in mind.



ArjoHuntleigh AB
Hans Michelsensgatan 10
211 20 Malmö, Sweden

arjo

