

INSTRUCTIONS FOR USE

Carino



WARNING

To avoid injury, always read this Instructions for Use and accompanied documents before using the product.



Mandatory to read the Instructions for Use

Design Policy and Copyright

® and ™ are trademarks belonging to the Arjo group of companies.

© Arjo 2019.

As our policy is one of continuous improvement, we reserve the right to modify designs without prior notice. The content of this publication may not be copied either whole or in part without the consent of Arjo.

Contents

Foreword	4
Intended Use	5
Safety Instructions	6
Preparations	7
Parts Designation	8
Product Description / Functions	10
Lifting Function (High/Low)	10
Leg Rests	10
Foot Supports	10
Driving Handles	10
Castors	11
Safety Belt	11
Armrests	11
Hand Control	11
Seat	11
Battery	12
Battery Charger	12
Emergency Stop	12
Emergency Lowering	13
Automatic Safety Stop	13
Neck Pillow	14
Back Pillow (Accessory)	14
Seat Cushion (Accessory)	14
Bedpan (Accessory)	14
Toilet Adapter (Accessory)	14
Getting the Patient Seated	16
Transfer	20
Transfer to the Shower	21
After the Shower	22
Transfer to the Toilet	24
Home Care Use	26
Battery Instructions	28
Cleaning and Disinfection Instructions	29
Care and Preventive Maintenance	32
Troubleshooting	36
Technical Specifications	37
Dimensions	39
Labels	41
List of Standards and Certificates	43
Electromagnetic Compatibility	44
Parts and Accessories	46

Foreword

Thank You for Purchasing Arjo Equipment.

Your *Carino* height adjustable hygiene chair is part of a series of quality products designed especially for hospitals, nursing homes and other health care use.

Please contact us if you have any questions about the operation or maintenance of your Arjo equipment.

Please Read this *Instructions for Use* Thoroughly!

Please read this *Instructions for Use (IFU)* in its entirety before using your *Carino* height adjustable hygiene chair. Information in the *IFU* is crucial to the proper operation and maintenance of the equipment, and will help protect your product and make sure that equipment performs to your satisfaction. Some of the information in this *IFU* is important for your safety and must be read and understood to help prevent possible injury.

Unauthorized modifications on any Arjo equipment may affect its safety. Arjo will not be held responsible for any accidents, incidents or lack of performance that occur as a result of any unauthorized modification to its products.

Report Unexpected Operations or Events

Contact your local Arjo representative if any unexpected operations or events occur. The contact information appear on the last page of this *IFU*.

Serious incident

If a serious incident occurs in relation to this medical device, affecting the user, or the patient then the user or patient should report the serious incident to the medical device manufacturer or the distributor. In the European Union, the user should also report the serious incident to the Competent Authority in the member state where they are located.

Service and Support

Service should be performed regularly on your *Carino* hygiene chair every year by Arjo qualified personnel to make sure the safety and daily operation of your product.

If you require further information, please contact your local Arjo representative who can offer

comprehensive support and service programs to maximize the long-term safety, reliability and value of the product.

Contact your local Arjo representative for replacement parts. Your service representative stocks the parts you will need. The contact information appears on the last page of this *IFU*.

Definitions in this IFU:

WARNING

Means:

Safety warning. Failure to understand and obey this warning may result in injury to you or to others.

CAUTION

Means:

Failure to follow these instructions may cause damage to all or parts of the system.

NOTE

Means:

This is important information for the correct use of this system or equipment.



Means:

The name and address of the manufacturer.

Intended Use

This equipment must be used in accordance with these safety instructions. Anyone using the equipment must also have read and understood the instructions in this *Instructions for Use (IFU)*.

If there is anything you are not sure about, contact your Arjo representative.

This equipment is intended for assisted hygiene care, showering and toileting of adult residents in care environments similar to senior/assisted living, group home, special care, nursing homes, hospitals and home care. The equipment is intended for indoor use.

The Carino height adjustable hygiene chair may only be used by appropriately trained caregivers with adequate knowledge of the care environment, its common practices and procedures and in accordance with guidelines in the *Instructions for Use (IFU)*.

Resident Assessment

We recommend that facilities establish regular assessment routines. Caregivers should assess each resident according to the following criteria prior to use:

- The resident must not weigh more than 140 kg (309 lbs.).
- The resident should understand and respond to instructions.
- It is intended for residents how are active or semi-active i.e. able to sit upright self-supported on the side of bed or toilet.

If the resident does not meet these criteria an alternative equipment/system shall be used.

Lifetime of the Equipment

The equipment must only be used for the purposes stated above.

The lifetime of this equipment is ten (10) years and the service life of the safety belt is two (2) years. Depending on the storage of the battery, the use frequency and the charging intervals, the service life of the battery is 2-5 years.

The lifetime and service life are stated providing that the preventive maintenance are being carried out in accordance with the instructions for care and maintenance in the Instructions for use (IFU).

Depending on level of wear some equipment parts such as castors and hand control may need to be replaced during the equipment lifetime according to information in the Instruction for use (IFU).

Safety Instructions

WARNING

To avoid explosion or fire, never use the equipment in oxygen rich environment, in presence of heat source or flammable anaesthetic gases.

WARNING

To avoid falling, make sure that the patient is positioned correctly and that the safety belt is being used, properly fastened and tightened.

WARNING

To avoid falling, make sure that the user weight is lower than the safe working load for all products or accessories being used.

WARNING

To avoid falling, make sure that the patient is positioned in accordance with this IFU.

WARNING

To avoid injury, make sure that the patient is not left unattended at any time.

WARNING

To avoid entrapment of the patient's or caregiver's legs or feet, make sure that they are kept clear of all obstacles.

WARNING

To avoid entrapment, make sure to keep the patient's hair, arms and feet close to the body and use designated grab supports during any movement.

WARNING

To avoid the device from tipping and the patient from falling, do not use the equipment on floor with recessed drains, holes or slopes exceeding a ratio of 1:50 (1.15°).

WARNING

To avoid the device in use from tipping, do not raise or lower other equipment close to it and be aware of stationary object when lowering.

WARNING

To avoid the patient from falling out of the device, make sure that the armrests are folded down during transfer.

WARNING

To avoid falling during transfer, always make sure that the brakes are applied on all equipment being used.

Preparations

Actions Before the First Use

(10 steps)

- 1 Visually check the package for damage. If the product looks damaged make a complaint to the transport agency.
- 2 The packaging should be recycled according to local regulations.
- 3 Check that all parts of the product are supplied. Compare with the product description in this *IFU*. If any part is missing or damaged - do NOT use the product.
- 4 Unpack the battery charger. Select and attach the adapter correctly suited to your power outlet. See *Battery charger IFU*.
- 5 Charge each battery for a minimum of 14 hours (Japan 3.5 hours).
- 6 Perform a functionality test. See section *Care and Preventive Maintenance on page 32*.
- 7 Disinfect the product. See section *Cleaning and Disinfection Instructions on page 29*.
- 8 Prepare an area that is dry, with good ventilation and out of direct sunlight for storage of the *Carino* hygiene chair.
- 9 Choose a designated area, where the Instructions for Use should be kept and is accessible at all times for the users.
- 10 Make sure to have a rescue plan in case of patient emergency and if the *Carino* hygiene chair gets stuck in an elevated position.

NOTE

If you have any questions, please contact your local Arjo representative for support and service.

Action Before Every Use

(4 steps)

- 1 Check that all parts of the *Carino* hygiene chair are in place. Compare to *Part Designations* page in this *IFU*.
- 2 Check accessories and parts for damage. If any part is missing or damaged - do NOT use the product
- 3 Assess the patient whether the safety belt is needed.

4

WARNING

To prevent cross-contamination always follow the disinfection instructions in this *IFU*.

Carino Hygiene Chair Directions

The directions *right* or *left* and intended driving direction in this *IFU* are shown below.

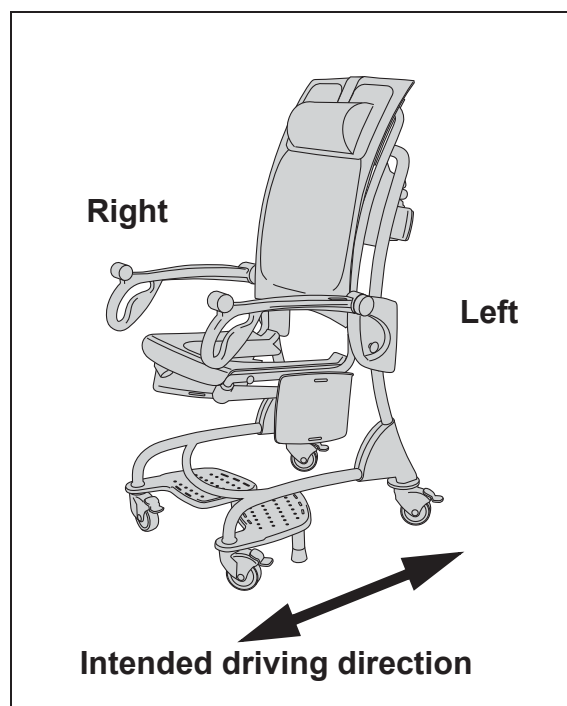

Parts Designation

- 1 Chassis
- 2 Lockable castors
- 3 Backrest
- 4 Neck pillow
- 5 Transfer handle
- 6 Transfer handle
- 7 Leg rests
- 8 Foot supports
- 9 Safety belt
- 10 Seat
- 11 Armrests
- 12 Hand control
- 13 Battery
- 14 Battery holder
- 15 Battery charger
- 16 Lifting unit
- 17 Cover left
- 18 Cover right
- 19 Emergency stop
- 20 Emergency lowering button
- 21 Lifting strap
- 22 Back pillow (accessory)
- 23 Seat cushion (accessory)
- 24 Bed pan with lid (accessory)
- 25 Toilet Adapter (accessory)



Applied part: Type BF. (Entire product) protection against electric shock in accordance with EN 60601-1

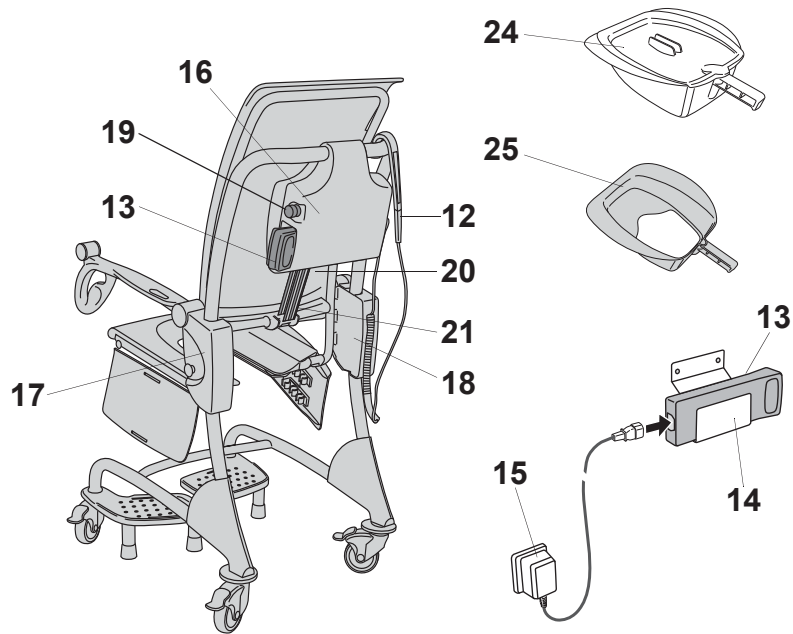
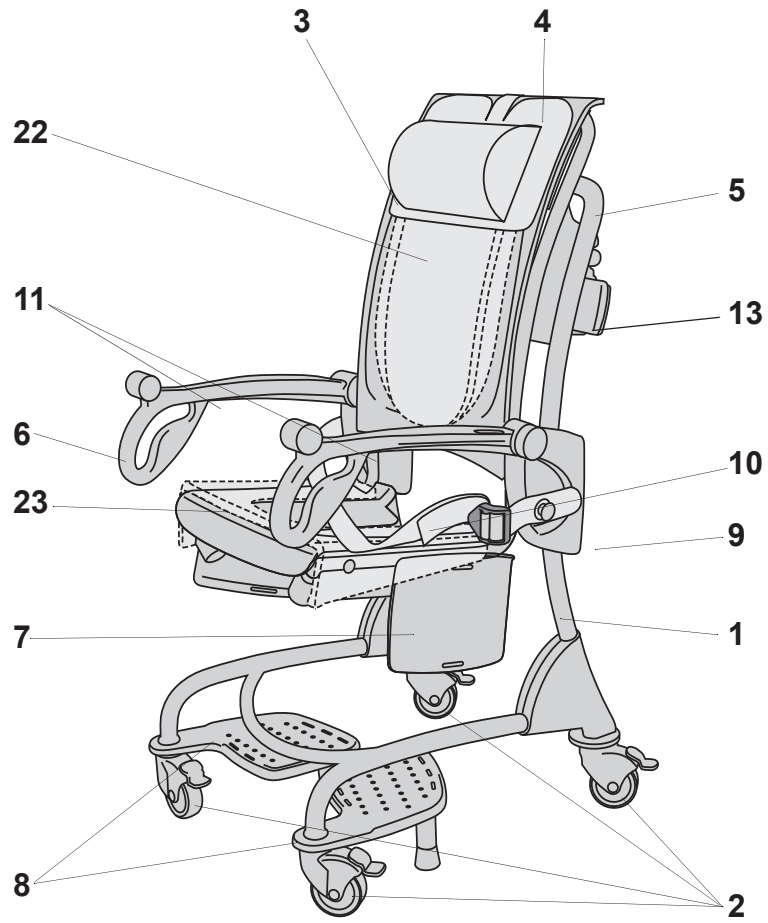

Product Description / Functions

The *Carino* hygiene chair has a total of 15 descriptions and functions.

Lifting Function (High/Low)

The chair can be adjusted to a suitable height over the toilet and to a comfortable height during showering. The higher the *Carino* hygiene chair is raised, the more reclined the patient's position will be.

Fig. 1

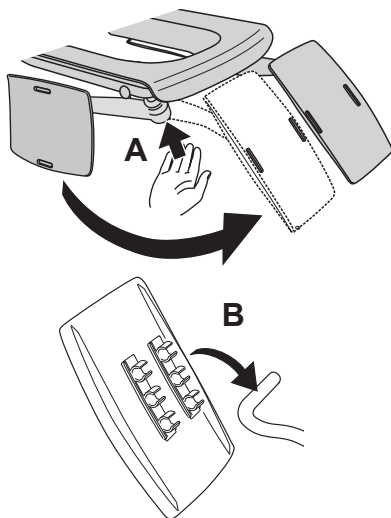

Leg Rests

Supporting the patient's legs gives the caregiver a correct working posture for example during a pedicure. The leg rests also give support to the patient's legs during the transfer. Press the leg rest connector (A) while folding out the leg rest. (See Fig. 1)

The leg rests are adjustable in three different positions depending on the length of the patient.

Adjust the position of the leg rest by removing the leg support and snap it back in to one of the three preferable heights (B). (See Fig. 1)

CAUTION

If the leg rest connector is not pressed in, the leg rest may break during the folding process.

Fig. 2

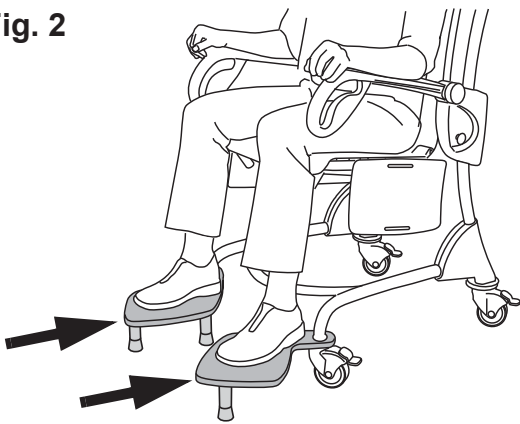

Foot Supports

WARNING

To avoid falling, make sure the floor is free from obstacles and that the foot rests are folded away before getting in or out of the equipment.

Fold out the foot support to let the patient rest their feet during the transfer in lower positions and during toileting. (See Fig. 2)

Fig. 3

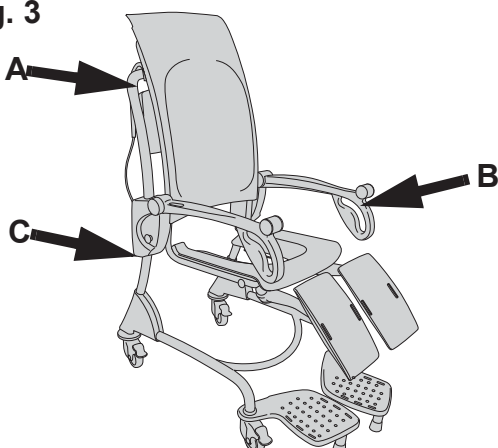

Driving Handles

The correct hand positioning for the caregiver during the transfer or positioning is on the driving handles behind the backrest (A) and integrated front armrest (B). Do not grab the chassis side bars (C). (See Fig. 3)

Fig. 1

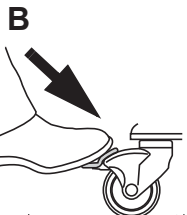
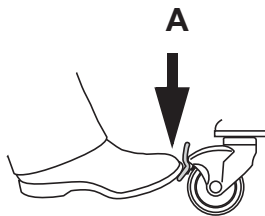
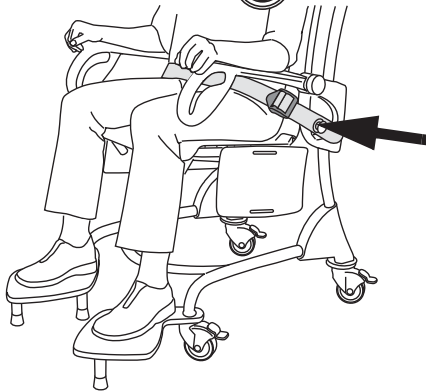

Fig. 2



Castors

The *Carino* hygiene chair is equipped with four lockable castors. Press down the brake pedal with your foot to brake (A) and press it forward to release the brake (B). To get the full effect apply brakes on all four castors. (See Fig. 1)

Safety Belt

WARNING

To prevent the patient from falling, make sure the safety belts are undamaged. If damaged, do NOT use the safety belts, replace with new ones before use.

Secure the patient with the safety belt if needed. The safety belt will secure the patient in the chair. Fasten at the knobs on either side of the backrest and adjust the length on the buckle. Make sure the safety belt is attached at all times to avoid it from laying on the floor causing someone to trip over it. Make sure the safety belt is close to the patient's body. (See Fig. 2)

Armrests

WARNING

To avoid the patient from falling out of the device, make sure that the armrests are folded down during transfer.

During the disinfection, the armrest can be folded up and down for easier disinfection underneath the armrest.

Fig. 3

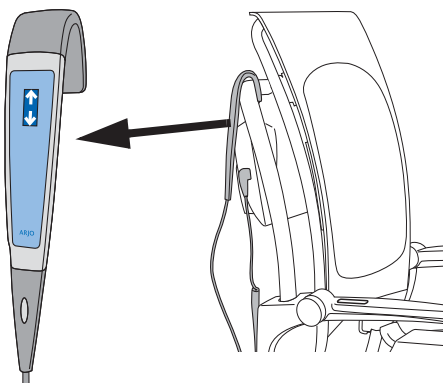

Hand Control

The hand control has an integrated hook, making it easier to attach it to various parts of the chair.

A set of buttons marked with arrows pointing upwards or downwards controls the raising and lowering of the chair. (See Fig. 3)

Fig. 4

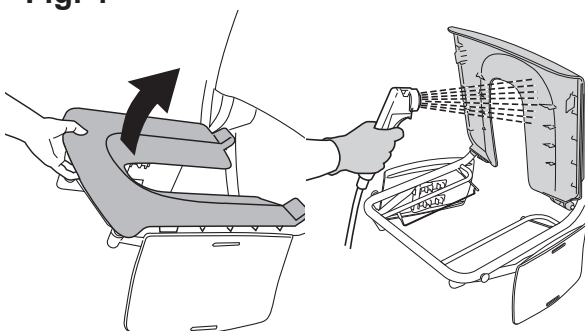

Seat

The seat has a comfortable design and can be folded up for cleaning and disinfecting. The seat is fixed in its normal position by a snap-in attachment on the front edge of the seat. For optimal ergonomics during cleaning and disinfecting, fold the seat up with the *Carino* hygiene chair in a comfortable height. (See Fig. 4)

Fig. 1

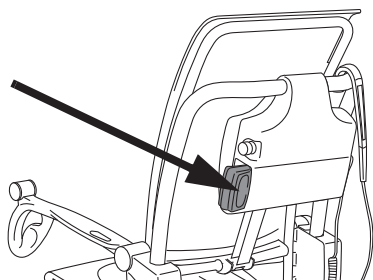

Battery

The battery (NEA0100) is positioned at the left side of the chair. See *Battery charger IFU*. (See Fig. 1)

NOTE

Make sure that the rounded ridge of the battery is turned upwards.

Fig. 2

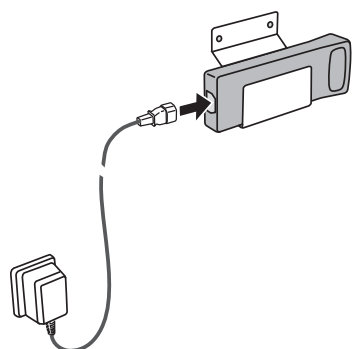

Battery Charger

The battery holder should be attached to a suitable wall and charger connected to a properly grounded wall socket. See *Battery charger IFU*. (See Fig. 2)

NOTE

Use the battery charger in a dry location. Do not install in bathrooms or any other wet areas.

Fig. 3 Emergency stop

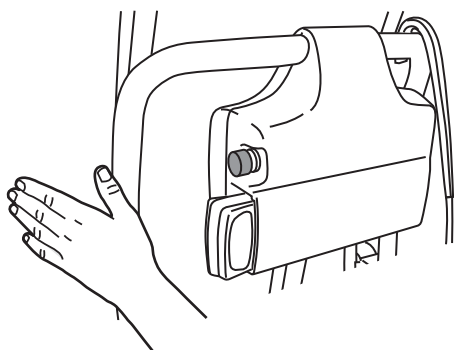

Emergency Stop

In case of an emergency, all functions can be stopped by pushing the red button on the left side of the lifting unit. The emergency stop will override important safety functions. (See Fig. 3)

NOTE

To reset the emergency stop function, turn the red button clockwise.

CAUTION

This emergency stop function should ONLY be used in an emergency.

If the emergency stop has been used due to malfunction, contact an Arjo Service Technician for general inspection of the *Carino* hygiene chair.

Emergency Lowering

CAUTION

Stop pressing the emergency lowering button when the hygiene chair stops. By continuing to press the button it will feed the lifting strap backwards and the button operation will become reversed.

Contact an Arjo service technician if this occurs.

WARNING

To avoid injury, only use the emergency lowering when normal lowering is impossible. Use extreme care during lowering.

NOTE

The emergency lowering overrides important safety functions and should only be used when the hand control is not working.

If an electrical failure occurs to the hand control, the chair can be lowered with the press of a button. The emergency lowering button is located under the lifting unit. (See Fig. 1)

- 1 Remove the orange plug.
- 2 Press the emergency lowering button with your finger.

Automatic Safety Stop

When a surrounding object stops the raising or lowering of the *Carino* hygiene chair, the automatic safety stop function will activate and stop the chair movement. Move the chair or the obstruction and continue raising or lowering.

Fig. 1 Emergency lowering

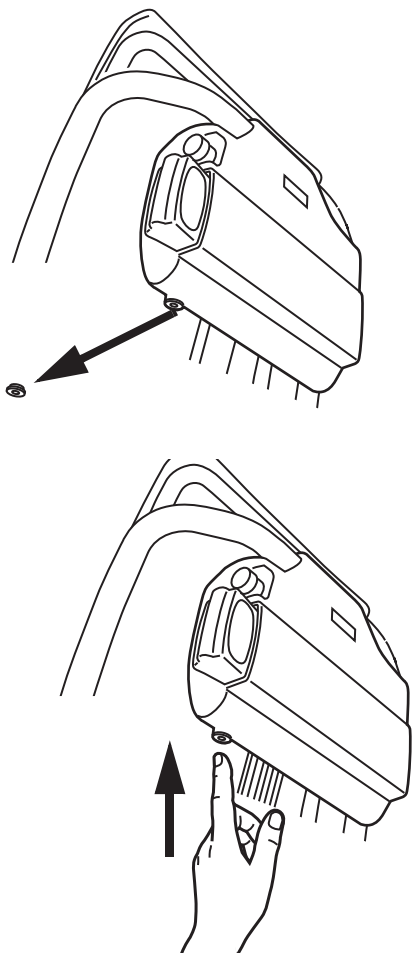
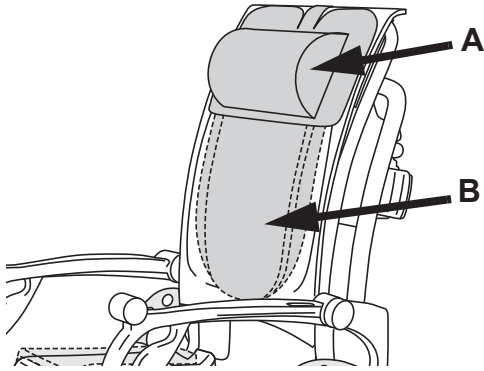

Fig. 1



Neck Pillow

The neck pillow (A) gives comfort and support during the transfer and showering. (See Fig. 1)

Back Pillow (Accessory)

The back pillow (B) supports the back and it's easy to adjust based on the patient's height. (See Fig. 1)

Fig. 2

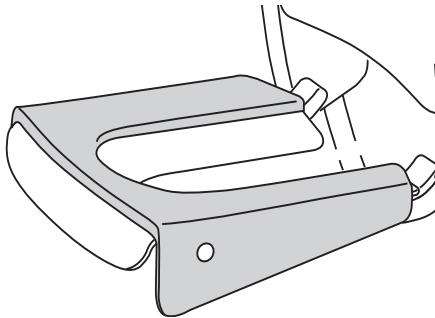

Seat Cushion (Accessory)

The seat cushion can be used for pressure sensitive patients. (See Fig. 2)

Fig. 3

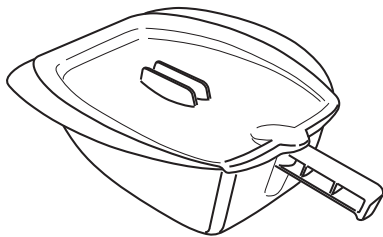

Bedpan (Accessory)

WARNING

To avoid entrapment or pinching of genitals, make sure there is enough clearance during movement over the tub edge, toilet, bedpan or other furniture.

The bed pan can be fitted from the back under the seat. (See Fig. 3)

Fig. 4

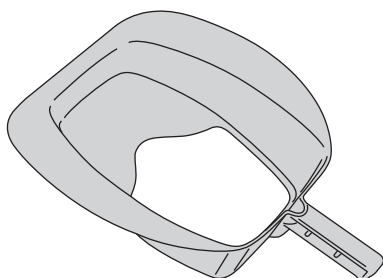

Toilet Adapter (Accessory)

The toilet adapter is used as a protection between the toilet chair and *Carino* hygiene chair to prevent splashing during toilet visits. It can be fitted from the back under the seat just like the bedpan. (See Fig. 4)

Intentionally left blank

Getting the Patient Seated

Fig. 1

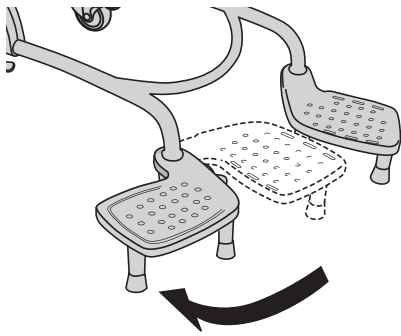

Independent Patient

Follow these 10 steps from a standing position or using a walker to Carino hygiene chair

WARNING

To avoid falling, make sure the floor is free from obstacles and that the foot rests are folded away before getting in or out of the equipment.

Fig. 2

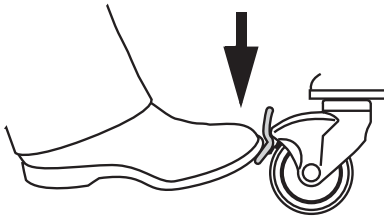

Fig. 3



Fig. 4



- 1 Fold away the leg rests and push aside the foot supports. (See Fig. 1)
- 2 Apply the brakes. (See Fig. 2)
- 3 Adjust the height of the Carino hygiene chair so that the edge of the seat touches the back of the patient's knees. (See Fig. 3)
- 4 Let the patient hold on to the armrest so that he or she can lean on it. (See Fig. 4)
- 5 Undress the lower part of the patient. (See Fig. 4)

Continue with the steps on the next page.

Fig. 5



6 Help the patient to sit down. (See Fig. 5)

7 Use the safety belt if needed.

8 Raise the *Carino* hygiene chair to a height which is convenient for transfer and the patient's feet just above the foot supports. (See Fig. 6)

9 Apply the foot supports on *Carino* hygiene chair. (See Fig. 7)

10 Transfer the patient to the shower or the toilet.

Fig. 6



Fig. 7

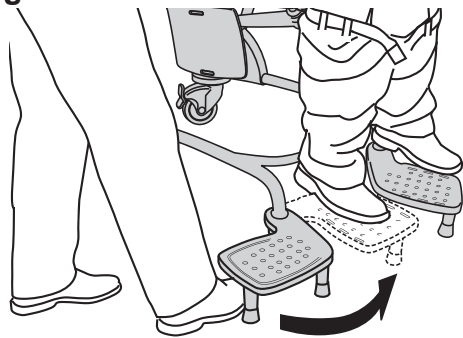

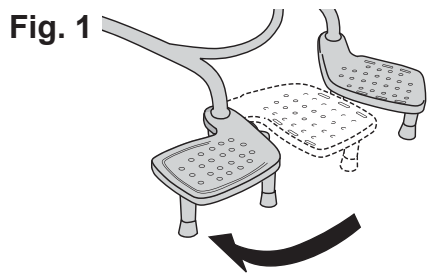

Fig. 2

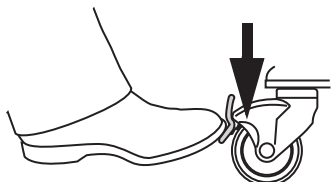

Fig. 3



Fig. 4



Dependent Patients

Follow these 13 steps from an active lift (standing and raising aid) to Carino hygiene chair

Follow the separate operating instructions regarding the actual lift.

- 1 Fold away the leg rests and push aside the foot supports. **(See Fig. 1)**
- 2 Apply the brakes on the *Carino* hygiene chair. **(See Fig. 2)**
- 3 Place the lift with the patient as close as possible to the *Carino* hygiene chair. **(See Fig. 3)**
- 4 Undress the lower part of the patient. **(See Fig. 3)**
- 5 Position the patient straight over the seat of *Carino* hygiene chair using the active lift. **(See Fig. 4)**

Continue with the steps on the next page.

Fig. 5

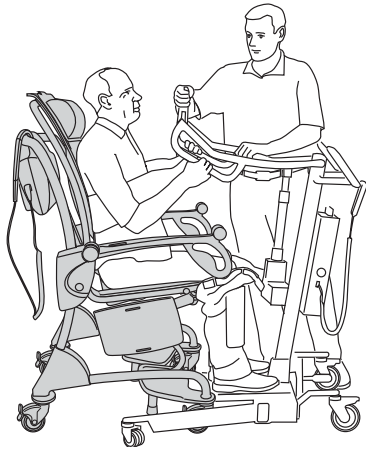

- 6 Lower the lift until the patient reaches the seat. **(See Fig. 5)**
- 7 Remove the sling. **(See Fig. 5)**
- 8 If needed, secure the patient in the *Carino* hygiene chair with the safety belt. **(See Fig. 5)**
- 9 Raise the chair so the patient's feet are free from the foot plate of the active lift.
- 10 Remove the active lift.

Fig. 6

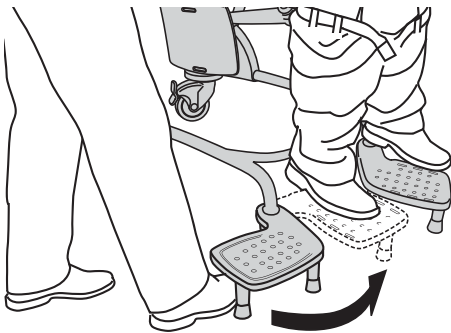

- 11 Apply the foot supports on the *Carino* hygiene chair. **(See Fig. 6)**
- 12 Lower the *Carino* hygiene chair so the patient's feet rest on the foot supports.
- 13 Transfer the patient to the shower or the toilet.

Transfer

There are two different ways to take the *Carino* hygiene chair with a patient to the shower room or toilet.

WARNING

To avoid entrapment, make sure to keep the patient's hair, arms and feet close to the body and use designated grab supports during any movement.

Fig. 1



Method 1

The *Carino* hygiene chair is pushed from the back and the patient's feet are placed on the foot supports. (See Fig. 1)

Fig. 2



Method 2

The *Carino* hygiene chair is pushed at a comfortable height from the front and the patient does not use foot supports or leg rests. (See Fig. 2)

Transfer to the Shower

Fig. 1



Follow these 7 Steps.

NOTE

To ease the process, undress the patient before entering the *Carino* hygiene chair.

- 1 Apply the brakes.
- 2 Undress the upper part of the patient's body. (See Fig. 1)
- 3 Raise the chair to a comfortable height.
- 4 Remove the remainder of the patient's lower body clothing.
- 5 Apply the leg rests.

Fig. 2

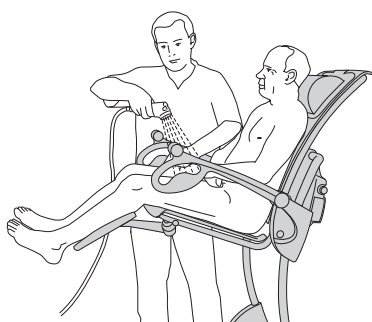

WARNING



To prevent scalding, always check the water temperature with your naked hand before directing the water on the patient. Do not use gloves as it may insulate to the extent that the water temperature can be misjudged. Point the flow of the water away from the patient.

Fig. 3



- 6 Wash and shower the patient in this ergonomic position. (See Fig. 2)

Fig. 4

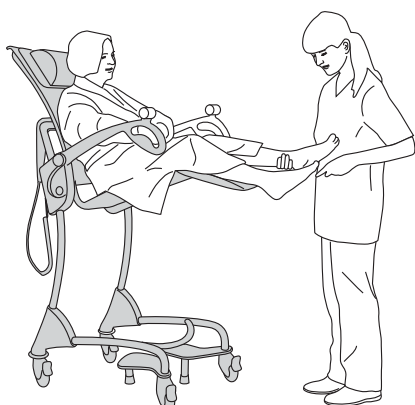

- 7 Adjust the height of the chair for a correct working posture while washing the hair or performing a pedicure. (See Fig. 3-4)

After the Shower

Fig. 1



Fig. 2

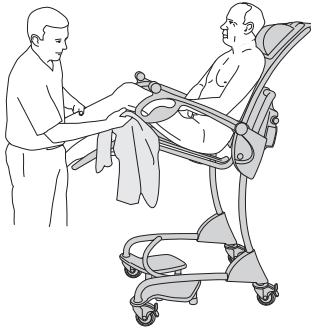

Fig. 3

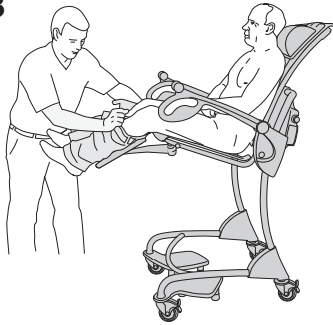

Fig. 4

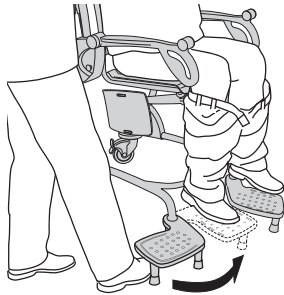
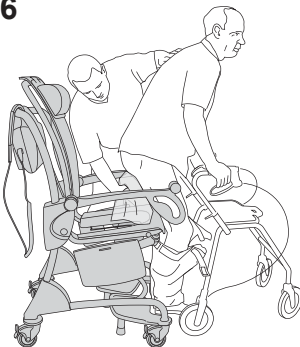

Fig. 5



Fig. 6



Drying and Dressing Alternative A - Independent Patients (8 steps)

- 1 Apply the brakes.
- 2 Dry all parts of the patient within reach with a towel. Do not forget the back of the legs. (See Fig. 1-2)
- 3 Dress the lower part of the body, as far as possible. (See Fig. 3)
- 4 Fold away the leg rests and apply the foot supports. (See Fig. 4)
- 5 Lower the chair.
- 6 Dress the upper part of the patient's body. (See Fig. 5)
- 7 Fold away the foot supports and let the patient stand up on the floor while drying the backside. (See Fig. 6)
- 8 Finish dressing the lower part of the body.

Fig. 1



Fig. 2



Fig. 3

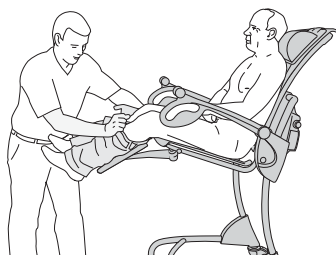

Fig. 4

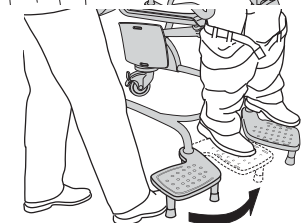

Fig. 5



Fig. 6



Fig. 7



Drying and Dressing Alternative B - Dependent Patients

(12 steps)

- 1 Apply the brakes.
- 2 Dry all parts of the patient within reach with a towel. Do not forget the back of the legs. (See Fig. 1-2)
- 3 Dress the lower part of the body, as far as possible. (See Fig. 3)
- 4 Fold away the leg rests and apply the foot supports. (See Fig. 4)
- 5 Lower the chair.
- 6 Dress the upper part of the patient's body. (See Fig. 5)
- 7 Fold away the foot supports.
- 8 Bring the active lift (standing and raising aid) in a frontal position close to the *Carino* hygiene chair so the patient's feet reach the foot plate of the active lift. (See Fig. 6)
- 9 Apply back support sling of the active lift.
- 10 Raise the patient.
- 11 Dry the backside of the patient. (See Fig. 7)
- 12 Finish dressing the lower part of the body.

Transfer to the Toilet

WARNING

To prevent cross-contamination, always follow the disinfection instructions in this IFU.

The *Carino* hygiene chair can be used regardless of whether the toilet is attached to the wall or to the floor. Preferably a toilet with a relatively long seat is recommended.

See the measurements below on matching toilet chairs:

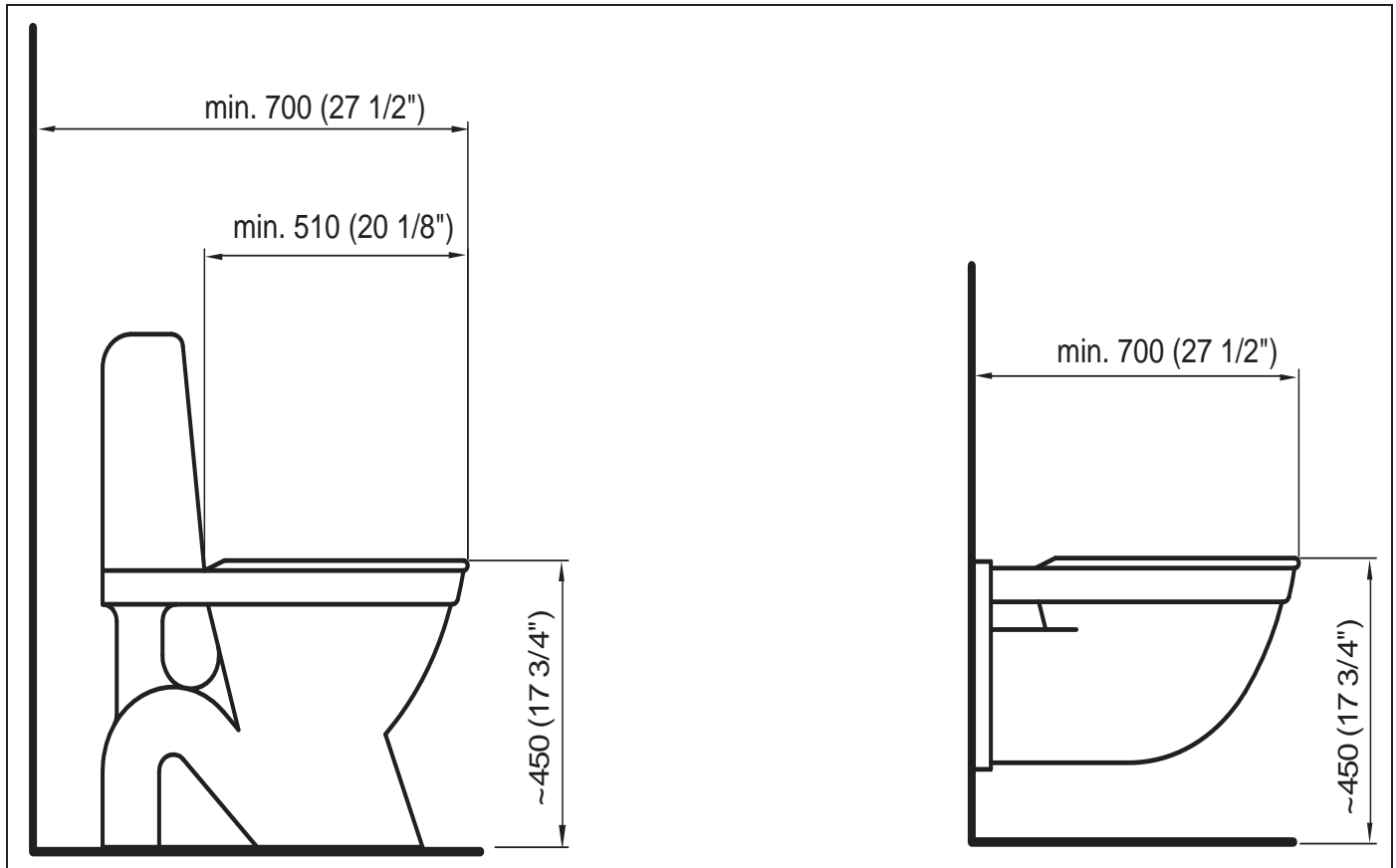

To Use the Toilet with the Carino hygiene chair – Follow these 10 Steps.

Fig. 1



- 1 Place the *Carino* hygiene chair with the patient close to the toilet.
(See Fig. 1)
- 2 Raise the chair to a comfortable height for the caregiver.
(See Fig. 2)

WARNING

To avoid entrapment or pinching of genitals, make sure there is enough clearance during movement over the tub edge, toilet, bedpan or other furniture.

Fig. 2



- 3 Position the *Carino* hygiene chair directly over the toilet bowl using the transfer handles on the armrests. Lower the chair and apply the castor brakes. (See Fig. 2)
- 4 When the patient is ready, release the brakes and remove the chair from the toilet bowl.
- 5 Raise the *Carino* hygiene chair.
- 6 Apply the castor brakes again.
- 7 Clean and dry the patient.
- 8 Lower the *Carino* hygiene chair.
- 9 Release the brakes.
- 10 Ready for transfer.

Home Care Use

For Distributors and Renters

When transporting the Carino hygiene chair to the customer with a van:

- Make sure the lift is properly secured during transport.
- Avoid manoeuvring the hygiene chair/shower and toilet chair in dirty ground when transporting it to and from the van.
- No person is allowed to sit in the product during transport of the product in vehicles.

When delivering the Carino hygiene chair make sure that:

- You read this *IFU* together with the receiver (including relatives and caregivers).
- Show the features and intended usage described in the *IFU* with help of the real product.
- The user has understood the cleaning and disinfection instructions.
- Read all the warnings to the receiver.
- The environment fulfils all the requirements described in this *IFU*.

Cleaning and disinfection:

- Make sure that the cleaning and disinfection procedure described in this *IFU* always is carried out before the product reaches a new user.
- Make sure that the cleaning and disinfection procedure described in this *IFU* always is carried out before and after any type of service procedure.

Using the Carino hygiene chair

Before using the Carino hygiene chair in home environment make sure that (See Fig. 1-2):

WARNING

To avoid the device from tipping and the patient from falling, do not use the equipment on floor with recessed drains, holes or slopes exceeding a ratio of 1:50 (1.15°).

- All caregivers, including relatives, have read and understood the instructions in this *IFU*.
- All carpets and rugs in the environment are removed.
- All thresholds in the environment are removed.
- All stairs and edges have a fence and safety gate to prevent the hygiene chair from rolling down.
- There is room enough in the environment for use of the hygiene chair / shower and toilet chair.

During Storage of the Carino hygiene chair make sure that:

WARNING

To avoid strangulation, make sure to never leave children unattended near the equipment.

- No children can access the hygiene chair /shower and toilet chair.
- No pets can come in contact with the hygiene chair /shower and toilet chair.
- The storage environment fulfils the requirements specified under *Technical Specifications on page 37*.

Fig. 1

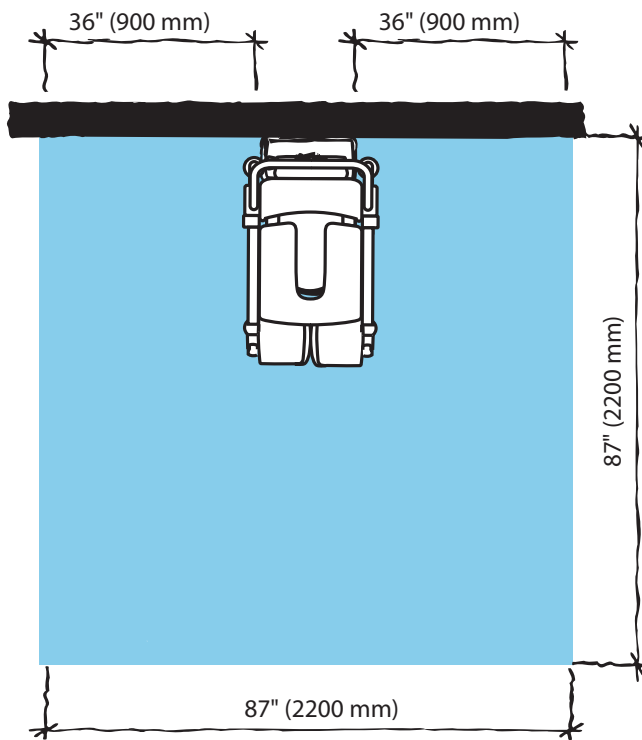
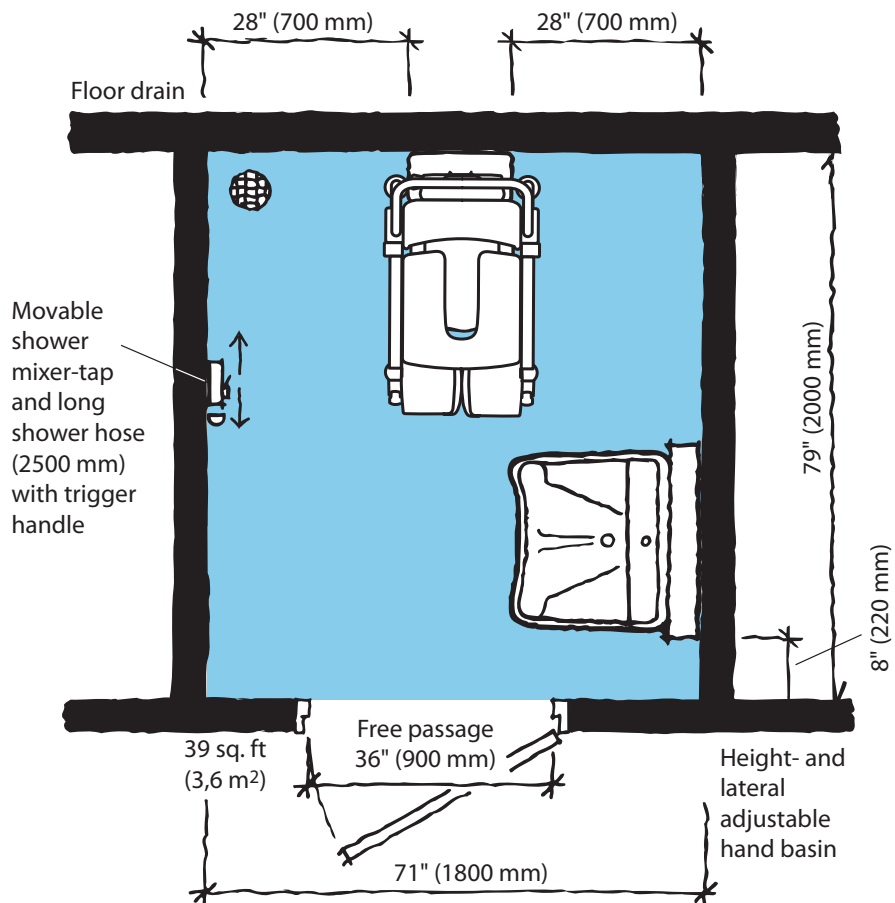

Fig. 2



Battery Instructions

WARNING

To avoid bodily injury, do NOT crush, puncture, open, dismantle or otherwise mechanically interfere with the battery.

- Should the battery casing crack and cause contents to come in contact with skin or clothing, rinse immediately with plenty of water.
- If contents come in contact with the eyes, rinse immediately with plenty of water and seek medical attention.

Inhalation of the contents can cause respiratory irritation. Provide fresh air and medical attention.

- Be careful not to drop the battery.
- Contact the appropriate local authority for advice when disposing of batteries.
- Check label on the battery.

Storage of Batteries

- The battery is delivered charged but we recommend you recharge the battery when received due to a slow self discharge.
- This battery will slowly self discharge when not used.
- A battery not in use should be stored between -0 °C (32 °F) and 30 °C (86 °F).
- For maximum battery performance do not store the battery above 50 °C (122 °F).

Charging Intervals

- To prolong the life of the battery, charge it at regular intervals, i.e. every night.
- If the *Carino* hygiene chair is used frequently, it is recommended to use two batteries, one in operation and one as a stand-by in the charger.
- It is recommended that a battery not in use is left in the charger. There is no risk of overcharging the battery.

Battery Service Life

Make sure to always have two well functional batteries, one to use and one in storage.

If using a freshly charged battery and the battery indicator starts to flash and sound after only a few activities are carried out, it is time to order a new battery.

Low Charge Warning

NOTE

A beeping sound while using the chair will be heard when the battery needs charging.

Installation of Charger

See *NEA 8000 Battery Charger IFU*.

How to Charge the Battery

See *NEA 8000 Battery Charger IFU*.

Cleaning and Disinfection Instructions

Only use Arjo Branded Disinfectant (e.g. Arjo Clean™).

If you have any questions regarding disinfecting the *Carino* hygiene chair or wish to order disinfectant, contact Arjo Customer Service. See section *Parts and Accessories* on page 46.

Make sure to have the Material Safety Data Sheets (MSDS) available for the disinfectant being used.

WARNING

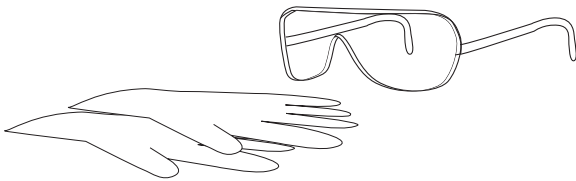

To avoid eye and skin damage, always use protective glasses and protective gloves. If contact occurs, rinse with plenty of water. If eyes or skin become irritated, consult a physician. Always read the IFU and the Material Safety Data Sheet of the disinfectant.

WARNING

To prevent cross-contamination, always follow the disinfection instructions in this IFU.

WARNING

To avoid eye or skin irritation, never disinfect in the presence of a patient.

CAUTION

To avoid damage on the equipment only use Arjo branded disinfectants.

Allowed Disinfectants

- Arjo Clean
- Arjo General Purpose Disinfectant
- Arjo Disinfectant Cleanser IV
- Arjo All Purpose Disinfectant
- Arjo CenKleen IV

Accessories for Disinfecting the Carino hygiene chair

- Protective gloves
- Protective glasses
- Spray bottle with disinfectant or disinfection spray handle with disinfectant
- Spray bottle with water or shower handle with water
- Cloths - wet and dry
- Disposable towels
- Soft bristle brush
- Long handled soft bristled brush

Always Follow these 21 Steps for Proper Cleaning and Disinfection

If an Arjo shower panel will be used, see respective *IFU*.

Removing visual residue (Step 1-3 of 21)

- 1 Detach pillow, cushions and safety belt.
- 2 Clean the *Carino* hygiene chair from visible residue using a cloth soaked in water or if more suitable by spraying/showering water using a brush and/or wipe with a clean cloth. Start from the top and move downwards.
- 3 Clean all removed parts from visible residue with a cloth soaked in water or shower water using a brush and/or wipe with a clean cloth (if applicable).

Cleaning (Step 4-10 of 21)

- 4 Put on protective gloves and eye wear. (See Fig. 1)
- 5 Spray disinfectant on the *Carino* hygiene chair. Use a brush and scrub thoroughly, especially on handles and hand control. (See Fig. 2-3)
- 6 Rinse the *Carino* hygiene chair thoroughly with water (approx. 25 °C (77 °F)) until all the disinfectant has been removed.
- 7 Spray disinfectant on the removed parts. Use a brush soaked in disinfectant for cleaning, scrub thoroughly.
- 8 Rinse the removed parts thoroughly with water until all the disinfectant has been removed.
- 9 Soak a cloth in disinfectant and wipe all other areas such as chassis.
- 10 Wet a new cloth with water and remove all traces of disinfectant on other areas. The cloth must occasionally be rinsed in running water when removing disinfectant.

Fig. 1

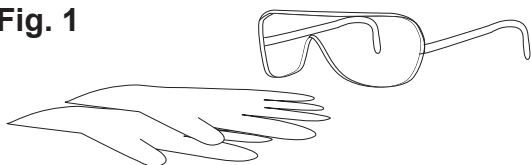

Fig. 2

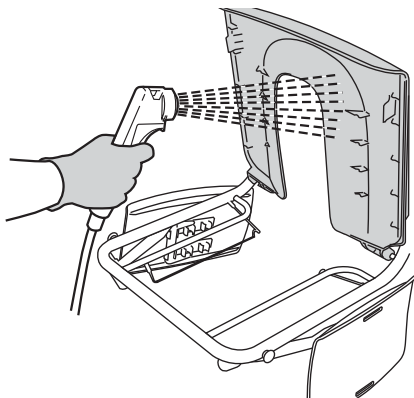
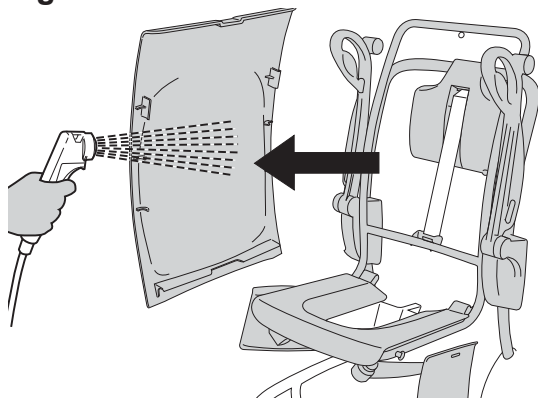
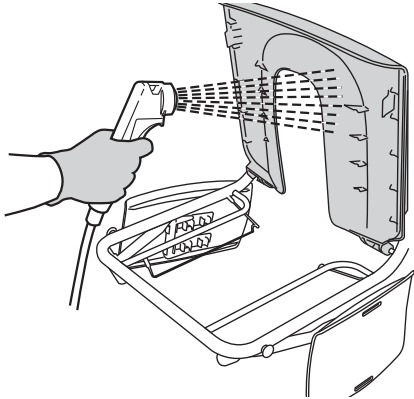

Fig. 3



Continue with the steps on the next page.

Fig. 1



**Disinfection
(Step 11-21 of 21)**

11 Spray disinfectant on the *Carino* hygiene chair.
(See Fig. 1-2)

12 Allow a disinfection time according to the instructions on the disinfectant bottle label.

13 Spray disinfectant on the removed parts.

14 Allow a disinfection time according to the instructions on the disinfectant bottle label.

Fig. 2

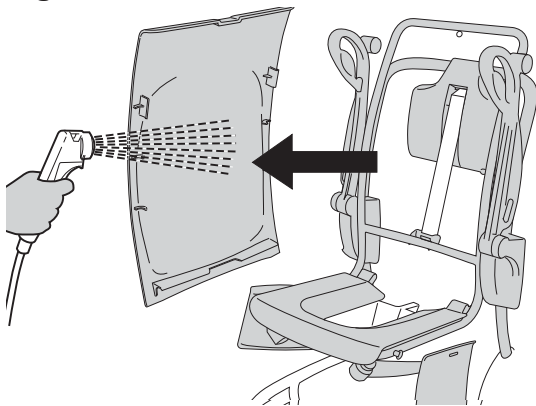

15 Soak a cloth in disinfectant and wipe all other areas such as chassis.

16 Allow a disinfection time according to the instructions on the disinfectant bottle label.

17 Spray or shower water (approx. 25 °C (77 °F)) and wipe with a clean cloth to remove all traces of the disinfectant on the *Carino* hygiene chair. The cloth should occasionally be rinsed in running water during removal of disinfectant.

18 Spray or shower water (approx. 25 °C (77 °F)) and wipe with a clean cloth to remove all traces of the disinfectant on the removed parts. The cloth should occasionally be rinsed in running water during removal of disinfectant.

19 Spray or shower water (approx. 25 °C (77 °F)) and wipe with a clean cloth to remove all traces of the disinfectant on remaining areas, such as chassis. The cloth should occasionally be rinsed in running water during removal of disinfectant.

20 If disinfectant cannot be removed, spray water on the affected part and wipe off with disposable towels. Repeat until all of the disinfectant has been removed.

21 Let all parts dry.

Care and Preventive Maintenance

Caregiver Obligations

The *Carino* hygiene chair is subject to wear and tear and the following actions must be performed when specified to make sure that the product remains within its original manufacturing specification.

WARNING

To avoid malfunction resulting in injury, make sure to conduct regular inspections and follow the recommended maintenance schedule. In some cases due to heavy use of the product and exposure to aggressive environment more frequent inspections should be carried out. Local regulations and standards may be more stringent than the recommended maintenance schedule.

NOTE

Product cannot be maintained and serviced while in use with the patient

PREVENTIVE MAINTENANCE SCHEDULE: Carino hygiene chair

CAREGIVER OBLIGATIONS Action/Check	Every DAY	Every WEEK	Every YEAR	Every 2:nd YEAR
Disinfect	X			
Visually check lifting strap	X			
Visually check safety belt		X		
Visually check all exposed parts		X		
Visually check mechanical attachments		X		
Check hand control and cable		X		
Check/clean castors		X		
Check cushions/pillows		X		
Visually check battery		X		
Replace the safety belt				X
Yearly checks by qualified personnel only			X	

WARNING

To avoid injury to both the patient and the caregiver, never modify the equipment or use incompatible parts.

Caregiver Obligations

Caregiver obligations shall be carried out by personnel with sufficient knowledge of the *Carino* hygiene chair, and by following the instructions in this *IFU*.

Every day

- **Disinfect.**

The *Carino* hygiene chair has to be disinfected immediately after every use. Arjo disinfectants should be used in recommended concentrations.

- **Visual check the exposed part of the lifting strap (See Fig. 1)**

On the back side of the chair when the chair is in its lowest position. Check the lifting strap for fraying, cuts, loose stitching. If the lifting strap is found damaged in any way, **do not use** the *Carino* hygiene chair. Contact your local Arjo representative.

Every week

- **Visually check the safety belt (See Fig. 2)**

Check the complete length for fraying, cuts, cracks, tears, that no inner fabric is showing and that no other damage is visible. If found cut or damaged, replace it.

- **Visually check all exposed parts**

Especially where bodily contact is made by either the patient or caregiver. Make sure no cracks or sharp edges have developed that could cause the patient or user injury or that has become unhygienic. Replace damaged parts.

- **Visually check mechanical attachments (See Fig. 3)**

Visually check that all screws and nuts are tightened and that there are no gaps.

Fig. 1

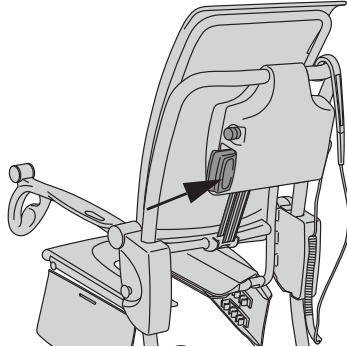

Fig. 2

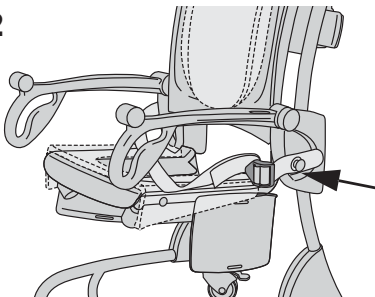

Fig. 3

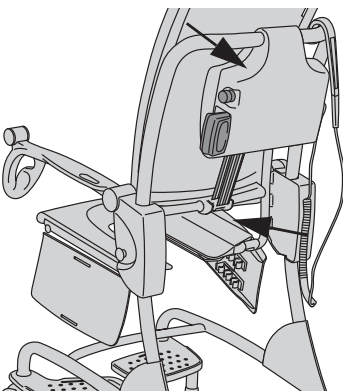
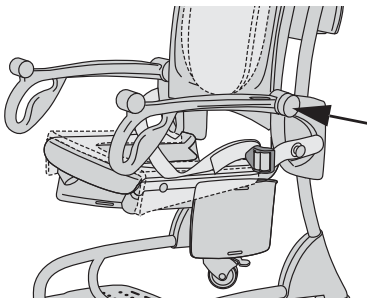
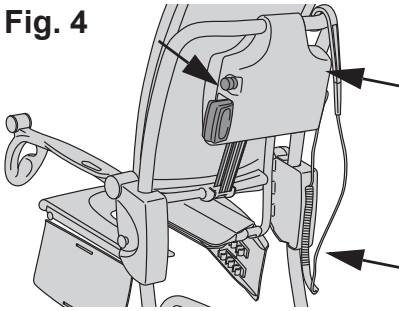
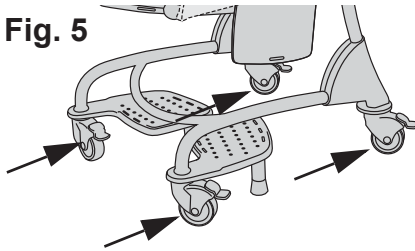

Fig. 4



- **Check hand control and cable (See Fig. 4)**
Visually check the condition of the hand control and its cable. If found cut or damaged, replace. Also check the emergency stop.
- **Check that the castors (See Fig. 5)**
are properly fixed and are rolling and swivelling freely. Clean with water. Castors can get affected by soap, hair, dust and floor cleaning chemicals.
- Check the function of the brakes by applying the brakes and test the *Carino* hygiene chair for movement.

Fig. 5



- **Check the cushions/pillows (See Fig. 6)**
to make sure there are no cracks or tears that would allow water to get into the filling. If there is such damage, replace damaged parts.

Fig. 6

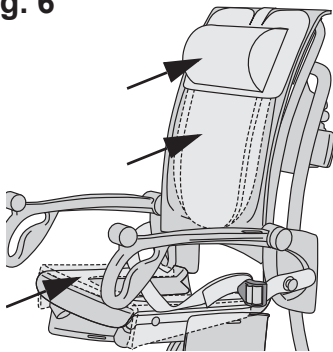

- **Visually check the condition of the battery charger, cable and the battery (See Fig. 7)**
Withdraw and replace immediately if damaged.

Fig. 7

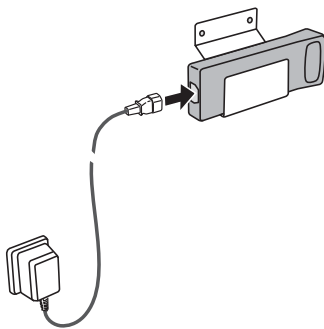

- **Perform functionality test.**
Test up and down motion by pressing up and then down on the hand control.
- **Test emergency stop function.** Press the down button at the same time pushing the emergency stop button, the motion shall stop. Release the emergency stop button.
Test automatic safety stop. Push the down button and pull up against the motion with your hand under the chair. The downward motion should stop.

Yearly Checks by Qualified Personnel only

The *Carino* hygiene chair must be serviced once a year in accordance with the *Maintenance and Repair Manual*.

WARNING

To avoid injury and/or unsafe product, the maintenance activities must be carried out at the correct frequency by qualified personnel using correct tools, parts and knowledge of procedures. Qualified personnel must have documented training in maintenance of this device.

NOTE

All Caregiver Obligations are to be checked when performing the Qualified Personnel Service. For details, see separate service instructions.

Troubleshooting

PROBLEM	ACTION
The chair keeps raising and lowering after the hand control button is released.	Activate the red emergency stop button and pull the battery out - remove the patient from the hygiene chair and contact qualified personnel.
The hygiene chair does not raise or lower when the hand control button is being pressed.	<ol style="list-style-type: none"> 1 Make sure that the battery is fully connected in the battery compartment. 2 Make sure that the hand control connection plug is properly connected to the socket. 3 Make sure that the battery is charged. <div style="border: 1px solid black; padding: 5px; margin: 10px 0;"> <p>WARNING To avoid injury, make sure that the patient is not left unattended at any time.</p> </div> <ol style="list-style-type: none"> 4 Make sure the emergency stop button is inactivated by turning the red knob clockwise.
The hygiene chair is hard to manoeuvre during transfer.	<ol style="list-style-type: none"> 1 Make sure all brakes are released. 2 Make sure all castors roll and swivel freely. If not, remove the patient from the hygiene chair and contact qualified personnel.
The hygiene chair is making abnormal sounds during lifting or transfer.	Remove the patient from the hygiene chair and contact qualified personnel.
ALARMS	ACTION
A beeping sound is heard as the hygiene chair is begin raised.	<p>The battery needs charging. Complete the patient transferring progress and change to a fully charged battery.</p> <div style="border: 1px solid black; padding: 5px; margin: 10px 0;"> <p>WARNING To avoid injury, make sure that the patient is not left unattended at any time.</p> </div>
Only a few activities are carried out before the battery indicator will flash and sound.	<p>Replace the battery with a fully charged one.</p> <p>If using a freshly charged battery and the battery indicator starts to flash and sound after only a few activities are carried out, it is time to order a new battery.</p>
The hand control buttons work reversed.	Contact qualified personnel.
The chair beeps in intervals. 5 s of beeping and 30 s of silence.	<p>Contact qualified personnel.</p> <p>Do not use the lift until fixed.</p>

Technical Specifications

Carino hygiene chair Model BOC100X-01	
Safe Working Load (SWL) (Maximum patient weight)	140 kg (309 lbs)
Weight	42 kg (93 lbs)
Maximum total weight of lift (lift + patient)	182 kg (402 lbs)
Mode of operation	ED maximum 10% 1 minute ON, 9 minute OFF
Sound level	63 dB (A)
Operating forces of control	2.7 N
Pollution degree	2

Electricity	
Supply voltage and lift nominal voltage	24 V DC
Maximum power	150 VA
Battery	NiMH; Arjo NEA 0100
Battery charger	NEA 8000
Battery capacity	2.5 Ah
Degree of protection	IP24 IP: Ingress Protection 2: Protection against insertion of fingers or similar objects. 4: Water splashing against the product from any direction does not effect safety or essential performance
Degree of protection - Hand control	IP X7 IP: Ingress Protection X: The protection against contact and ingress of objects is not specified for this product. 7: Immersion up to 1 m of the product does not effect safety or essential performance
Medical equipment	Type BF 
Fuse	T5AL 250 V

Component weights	
Battery	1.45 kg (3.2 lbs.)

Allowed Combinations

The Carino hygiene chair integrate with the following Arjo products Sara 3000, Sara Plus and Sara lite

No other combinations are allowed

Operating, Transport and Storage

Ambient temperature range -20 °C to +70 °C (-7 °F to +158 °F) Transport
-20 °C to +70 °C (-7 °F to +158 °F) Storage
+10 °C to +40 °C (+50 °F to +104 °F) Operation

Relative humidity range 10% to 80% Transport and Storage
15% to 93% Operation

Atmospheric pressure range 500 hPa to 1100 hPa Transport
500 hPa to 1100 hPa Storage
800 hPa to 1060 hPa Operation

Recycling

Package Wood and corrugated cardboard, recyclable

End of Life Disposal

- All batteries in the product must be recycled separately. Batteries are to be disposed in accordance with national or local regulations.
- Slings including stiffeners/stabilizers, padding material, any other textiles or polymers or plastic materials etc. should be sorted as combustible waste.
- Lift systems having electrical and electronic components or an electrical cord should be disassembled and recycled per Waste of Electrical and Electronic Equipment (WEEE) or in accordance with local or national regulation.
- Components that are primarily made up of different kinds of metal (containing more than 90% metal by weight) for example sling bars, rails, upright supports, etc., should be recycled as metals.

Dimensions

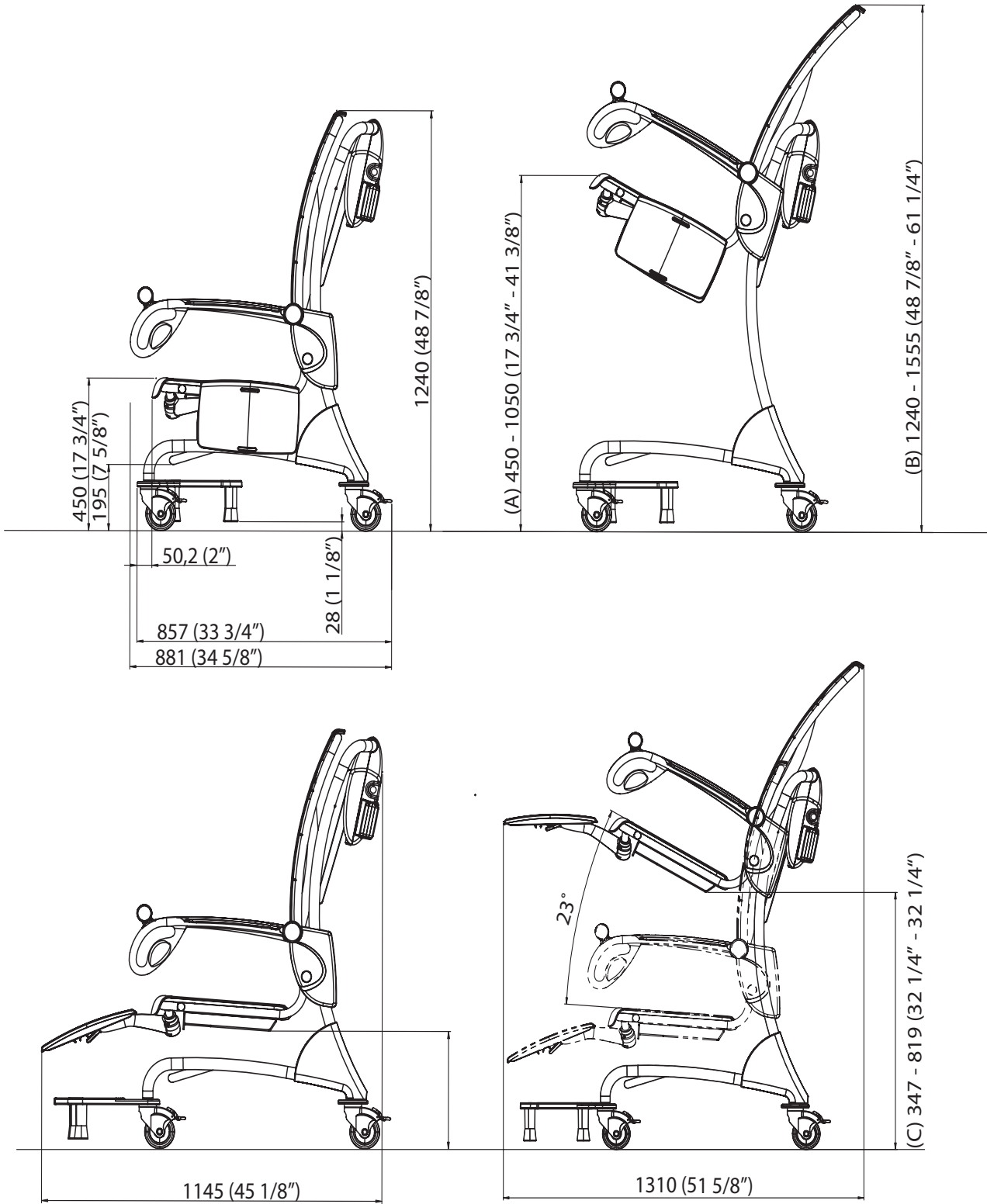

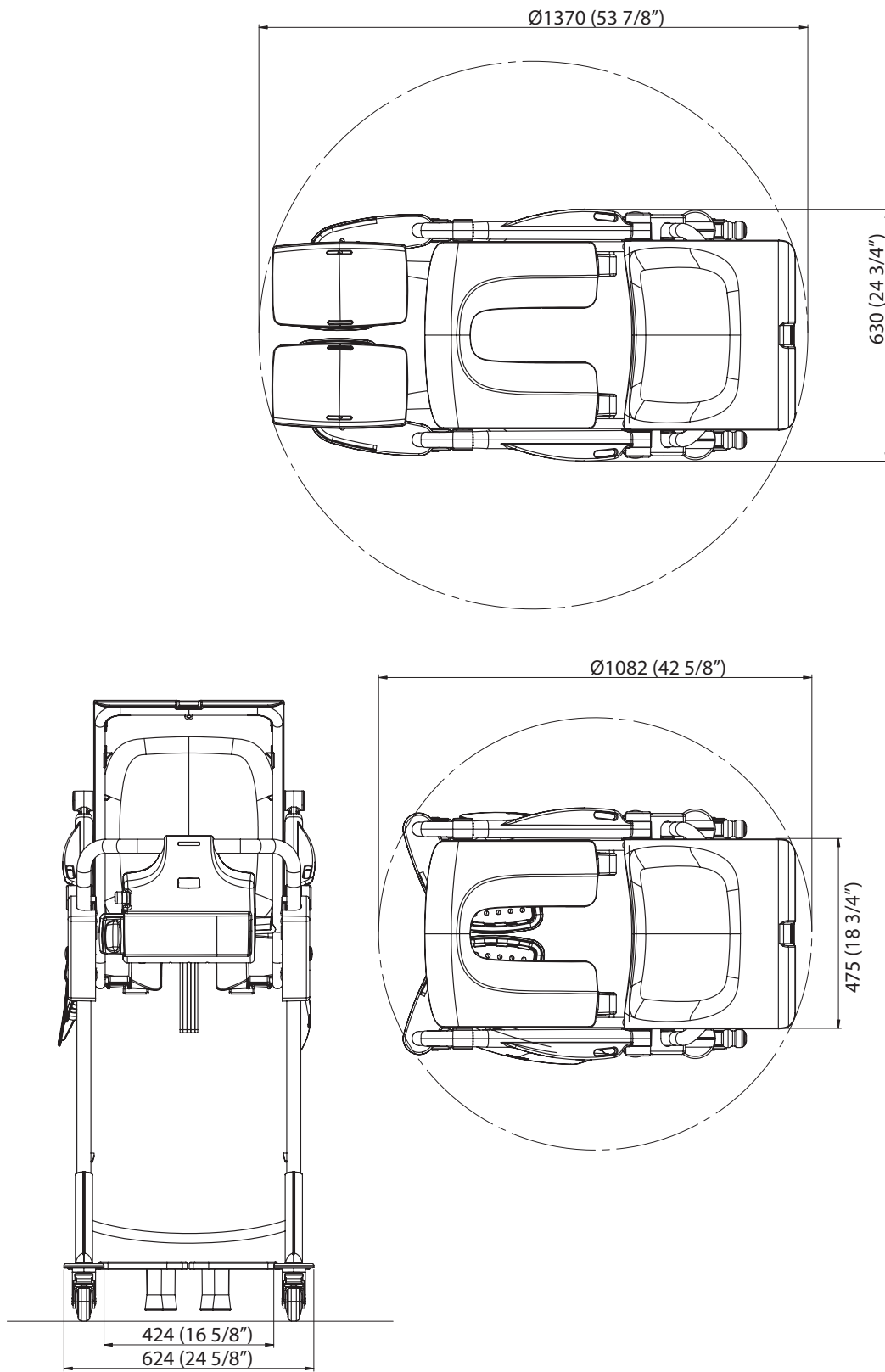









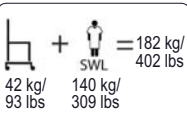

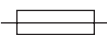



Labels

Label explanation

Approval Label	States approvals for the current product.
Battery Label	States safety and environmental information for the battery.
Data Label	States technical performance and requirements, e.g. Input Power, Input Voltage and maximum Patient Weight etc.
Emergency Lowering Label	States emergency information, see section <i>Emergency Lowering on page 13</i> .
Identification Label	States the product identification, serial number and year and month of manufacturing.
Lifting Strap Label	States the manufacturing date of the strap.

Symbol explanation

	Total mass of equipment including its safe working load.
SWL	Safe Working Load 140 kg (309 lbs.)
	Lifting stroke 600 mm (23 5/8")
24V DC	Supply voltage
MAX: 150 VA	Maximum power
	Fuse F1 - T5AL 250V
IP24	Degree of protection (i.e. the product is protected against insertion of fingers and splashing water)
NEA0100	Product No. of the battery
	A battery is the power source of this equipment.
ED max 10%	Mode of operation for Hi/Lo function: ED maximum 10%; Maximum 1 minute ON; Minimum 9 minutes OFF

	Type BF. Applied part: protection against electric shock in accordance with IEC 60601-1
	Mandatory to read the Instructions for Use
	Separate electrical and electronic components for recycling in accordance with the European Directive 2012/19/EU (WEEE).
	Emergency lowering of the hygiene chair.
	CE marking indicating conformity with European Community harmonised legislation
	Indicates the product is a Medical Device according to EU Medical Device Regulation 2017/745
	TÜV marking. The lift has been safety tested according to: EN/ISO 10535 and IEC 60601-1
	Environmental danger. Not for disposal.
	Recyclable
	Name and address of the manufacturer
	Manufacturing date

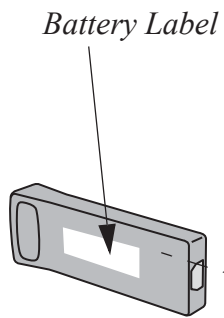

Emergency Lowering Label

Lifting Strap Label

Identification Label

*Data Label
Approval Label*

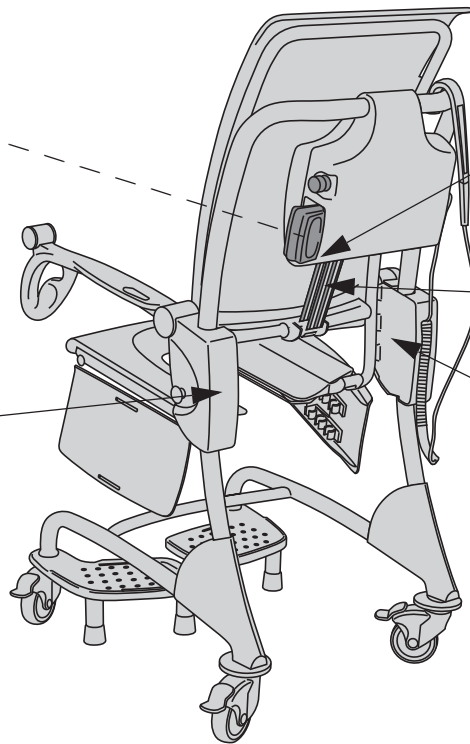

List of Standards and Certificates

STANDARD/CERTIFICATE	DESCRIPTION
EN/IEC 60601-1:2005 AMD1:2012	Medical Electrical Equipment - Part 1: General Requirements for Basic Safety and Essential Performance
ANSI/AAMI ES60601-1 (2005) AMD 1 (2012)	Medical Electrical Equipment - Part 1: General Requirements for Basic Safety and Essential Performance
CAN/CSA-C22.2 No. 60601-1:14	Medical Electrical Equipment - Part 1: General Requirements for Basic Safety and Essential Performance
ISO 10535:2006	Hoists for the transfer of disabled persons -- Requirements and test methods

Electromagnetic Compatibility

Product has been tested for compliance with current regulatory standards regarding its capacity to block EMI (electromagnetic interference) from external sources.

Some procedures can help reduce electromagnetic interferences:

- Use only Arjo cables and spare parts to avoid increased emissions or decreased immunity which can compromise the correct functioning of the equipment.
- Ensure that other devices in patient-monitoring and/or life-support areas comply to accepted emissions standards.

WARNING

Wireless communications equipment such as wireless computer network devices, mobile phones, cordless telephones and their base stations, walkie-talkies, etc. can affect this equipment and should be kept at least 1.5m away from the equipment.

Intended Environment: Home Healthcare Environment and Professional Healthcare facility environment.

Exceptions: HF Surgical Equipment and the RF Shielded room of an ME SYSTEM for magnetic resonance imaging

WARNING

Use of this equipment adjacent to or stacked with other equipment should be avoided because it could result in improper operation. If such use is necessary, this equipment and the other equipment should be observed to verify that they are operating normally.

Guidance and manufacturer's declaration – electromagnetic emission		
Emission test	Compliance	Guidance
RF emissions CISPR 11	Group 1	This equipment uses RF energy only for its internal functions. Therefore its RF emissions are very low and are not likely to cause any interference in nearby electronic equipment.
RF emissions CISPR 11	Class B	This equipment is suitable for use in all establishments, including domestic establishments and those directly connected to the public low voltage power supply network that supplies buildings used for domestic purposes.

Guidance and manufacturer's declaration – electromagnetic immunity

Immunity test	IEC 60601-1-2 test level	Compliance level	Electromagnetic environment – guidance
Electrostatic discharge (ESD) EN 61000-4-2	±2kV, ±4kV, ±8kV, ±15kV air ±8kV contact	±2kV, ±4kV, ±8kV, ±15kV air ±8kV contact	Floors should be wood, concrete or ceramic tile. If floors are covered with synthetic material the relative humidity level should be at least 30%.
Conducted disturbances induced by RF fields EN 61000-4-6	3V in 0,15 MHz to 80 MHz 6V in ISM and amateur radio bands between 0,15 MHz and 80 MHz 80% AM at 1 kHz	3V in 0,15 MHz to 80 MHz 6V in ISM and amateur radio bands between 0,15 MHz and 80 MHz 80% AM at 1 kHz	Portable and mobile RF communications equipment should be used no closer to any part of the product, including cables, than 1.0m, if the transmitter's output power rating exceeds 1W ^a Field strengths from fixed RF transmitters, as determined by an electromagnetic site survey, should be less than the compliance level in each frequency range ^b Interference may occur in the vicinity of equipment marked with this symbol: 
Radiated RF electromagnetic field EN 61000-4-3	Home Healthcare environment 10 V/m 80 MHz to 2,7 GHz 80% AM at 1 kHz	Home Healthcare environment 10 V/m 80 MHz to 2,7 GHz 80% AM at 1 kHz	
Proximity fields from RF wireless communications equipment EN 61000-4-3	385 MHz - 27 V/m 450 MHz - 28 V/m 710, 745, 780 MHz - 9V/m 810, 870, 930 MHz - 28 V/m 1720, 1845, 1970, 2450 MHz – 28 V/m 5240,5500, 5785 MHz - 9V/m	385 MHz - 27 V/m 450 MHz - 28 V/m 710, 745, 780 MHz - 9V/m 810, 870, 930 MHz - 28 V/m 1720, 1845, 1970, 2450 MHz - 28 V/m 5240,5500, 5785 MHz - 9V/m	
Electrical fast transient/burst EN 61000-4-4	±1kV SIP/SOP ports 100 kHz repetition frequency	±1kV SIP/SOP ports 100 kHz repetition frequency	
Power frequency Magnetic field EN 61000-4-8	30 A/m 50 Hz or 60 Hz	30 A/m 50 Hz	Power frequency magnetic fields should be at levels characteristic of a typical location in a typical commercial or hospital environment.

^a Field strengths from fixed transmitters, such as base stations for radio (cellular/cordless) telephones and land mobile radios, amateur radio, AM and FM radio broadcast and TV broadcast cannot be predicted theoretically with accuracy. To assess the electromagnetic environment due to fixed RF transmitters, an electromagnetic site survey should be considered. If the measured field strength in the location in which the product is used exceeds the applicable RF compliance level above, the product should be observed to verify normal operation. If abnormal performance is observed, additional measures may be necessary.

^b Over the frequency range 150 kHz to 80 MHz, field strengths should be less than 1 V/m.

Parts and Accessories

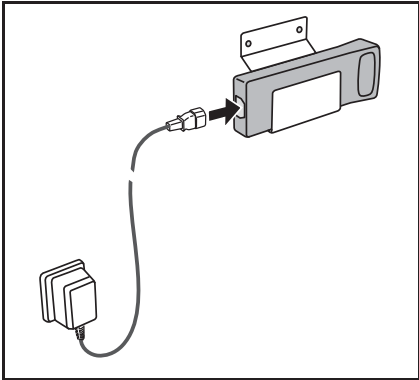

Battery charger and battery

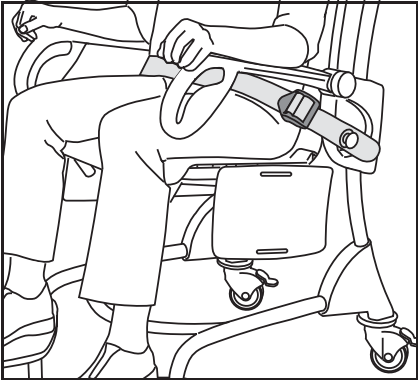

Safety belt

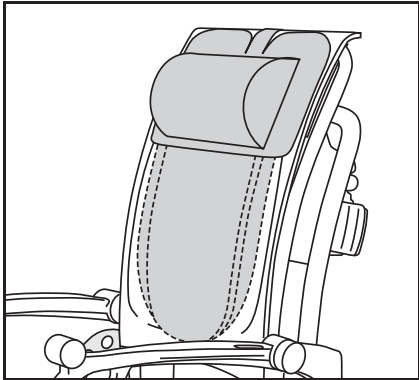

Back pillow and neck pillow

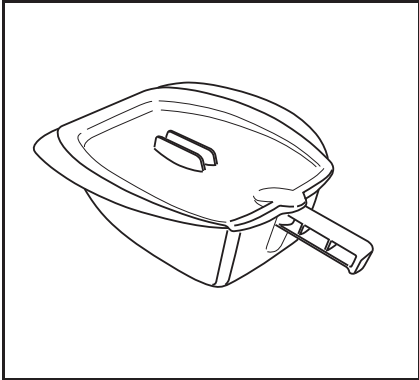

Bed pan with lid

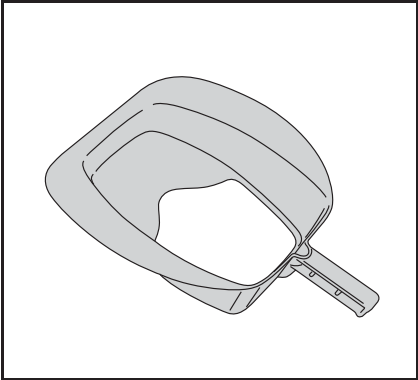

Toilet adapter

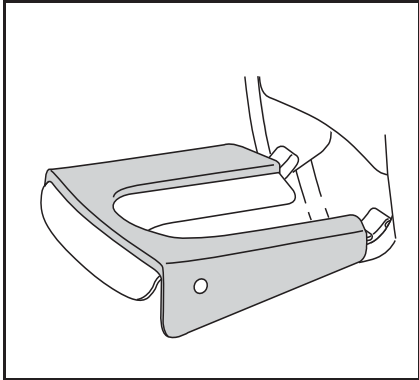

Seat cushion

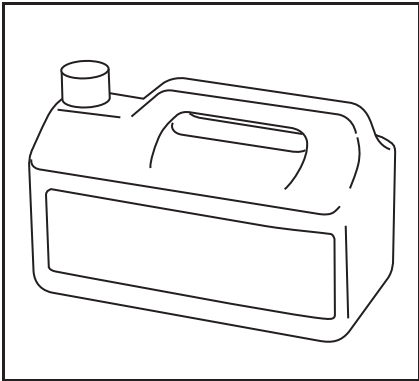

For disinfectant contact the Arjo local representative

At Arjo, we are committed to improving the everyday lives of people affected by reduced mobility and age-related health challenges. With products and solutions that ensure ergonomic patient handling, personal hygiene, disinfection, diagnostics, and the effective prevention of pressure ulcers and venous thromboembolism, we help professionals across care environments to continually raise the standard of safe and dignified care. Everything we do, we do with people in mind.



ArjoHuntleigh AB
Hans Michelsensgatan 10
211 20 Malmö, Sweden

arjo

