Sys*Stim[®] 228

Instruction Manual



1333 South Claudina Street
Anaheim, CA 92805, U. S. A.

Toll Free: (800) 854-9305

Telephone: (714) 533-2221 • FAX: (714) 635-7539

Web site: www.mettlerelectronics.com • email: mail@mettlerelectronics.com

Table of Contents

Section	Title	Page
1	Introduction	5
1.1	Introduction to the Sys*Stim 228	5
1.2	Introduction to this Manual	6
1.3	Safety Precautions	6
1.4	Caution	6
1.5	Shipping Damage	6
1.6	Package Contents	7
1.7	Limited Warranty	7
2	Symbol Glossary and List of Abbreviations	9
2.1	Symbol Glossary	9
2.2	List of Abbreviations	11
3	Installation	13
3.1	Installation Instructions	13
3.2	EMC Guidance	14
4	Operating Instructions	19
4.1	A Note About Electrodes	20
4.2	Operating Instructions	21
4.3	Electrode Positioning	26
4.4	Combination Therapy Using the Sys*Stim 228 and the Sonicator	29
5	Indications, Contraindications, Precautions and Adverse Reactions	31
5.1	Indications	31
5.2	Contraindications	31
5.3	Warnings	32
5.4	Precautions	32
5.5	Side Effects/ Adverse Reactions	33
6	Maintenance and Troubleshooting	35
6.1	Cleaning the Sys*Stim 228	35
6.2	Routine Maintenance	34
6.3	Troubleshooting the Sys*Stim 228	34
7	References	37
8	Specifications	39
8.1	General Specifications	39
8.2	Waveform Specifications	39
8.3	Amplitude Modulation Specifications	42
9	Accessories	43
9.1	Ordering Information	43
9.2	Sys*Stim 228 Accessories	43

List of Figures

No.	Title	Page
1.1	Sys*Stim 228 and Accessories	5
3.1	Sys*Stim 228, Back view – Mains Power Switch and Line cord connections	13
4.1	Front membrane panel and LED indicators	19
4.2	Electrode Sizes and Current Density	20
4.3	Quadpolar Electrode Placement Technique	27
4.4	Bipolar Electrode Placement Technique	27
4.5	Monopolar Electrode Placement Technique	28
4.6	Using the Pencil Electrode	28
4.7	Combination Therapy	30
4.8	Application of Combination Therapy	30
8.1	Interferential Waveform	39
8.2	Premodulated Waveform	40
8.3	Medium Frequency (<i>Russian</i>) Waveform	41
8.4	Biphasic Waveform	41

Section 1: Introduction

1.1 Introduction to the Sys*Stim 228

Thank you for purchasing the Sys*Stim 228 neuromuscular stimulator from Mettler Electronics Corp. The microprocessor controlled Sys*Stim 228 provides interferential, premodulated, medium frequency and symmetrical biphasic waveforms with enhanced reliability and ease of use.

The two-channel Sys*Stim 228 allows you to utilize two different waveforms using two different treatment timers simultaneously. You can choose between several different amplitude modulation options such as the surge, reciprocation and amplitude modulation (*interferential only, vector rotation*). The interferential and premodulated modes offer frequency modulation as well as a fixed frequency.

The membrane panel provides one touch entry for treatment parameters. An audible tone provides you with further reinforcement that you have made a selection. LED's guide you through the easy setup routine.

Use the lightweight and portable Sys*Stim 228 in home health as well as in the clinic. Teamed up with a Mettler Electronics Sonicator, the Sys*Stim 228 can provide combination therapy. Add the optional treatment cart along with a Sonicator® therapeutic ultrasound to create a mobile treatment center in your office.



Figure 1.1 – Sys*Stim 228

1.2 Introduction to This Manual

Read the contents of this manual before treating patients with the Sys*Stim 228.

This manual has been written to assist you with the safe operation of the Sys*Stim 228. It is intended for use by the owners and operators of the Sys*Stim 228. The goal of this manual is to direct the correct operation and maintenance of this unit.

The specifications and instructions presented in this manual are in effect at the time of its publication. These instructions may be updated at any time at the discretion of the manufacturer. To ensure that you have the most up-to-date information about your product, please go online to register it at <http://www.mettlerelectronics.com/product-registration/>.

1.3 Safety Precautions

The Sys*Stim 228 operates with high voltages. Servicing of the Sys*Stim 228 should be performed by qualified biomedical technicians with experience in neuromuscular stimulator service or it should be returned directly to the factory. To maximize safety during use, the unit should be plugged into a grounded wall outlet of proper voltage only. General safety guidelines for medical electronic equipment should be followed.

A maintenance manual for the Sys*Stim 228 is available from Mettler Electronics Corp. for a small fee. For more information, contact Customer Service by calling toll free at (800) 854-9305, *telephone: (714) 533-2221*, Fax: (714) 635-7539 or via email, *mail@mettlerelectronics.com*.

1.4 Caution

Federal law restricts the sale of this device to, or on the order of a physician, dentist, veterinarian or any other practitioner licensed by the law of the state in which he practices.

Use of controls or adjustments or performance of procedures other than those specified herein or use of unauthorized accessories with this device may result in exposure to hazardous electrical current and possible burns caused by abnormal current levels.

The electric energy delivered by this device may possibly be lethal. Treatment should be administered only under the direct supervision of a health care professional.

1.5 Shipping Damage

Your new Sys*Stim 228 is shipped complete in one carton. Upon receipt, please inspect the carton and the unit for visible and hidden damage. If you discover any damage, hold all shipping materials, including the carton, and call the shipping agent who delivered the unit.

The carton in which your new Sys*Stim 228 was received is specially designed to protect the unit during shipping. Please retain all shipping materials in the event that you will need to return your unit for servicing. NOTE: All warranty repairs are to be performed by Mettler Electronics Corp. or an authorized Mettler Electronics warranty repair center.

1.6 Package Contents

Your new Sys*Stim 228 comes complete with all the necessary components to perform neuromuscular electrical stimulation. Below is a list of items that are included in the shipping carton.

1. Sys*Stim 228
2. Two electrode cable sets, (ME 2260)
3. Two gray pin to banana adapters, (ME 2027)
4. One package each EZ Trodes, 2" diameter (ME 2221) and 3" diameter (ME 2222)
5. Detachable U.L. listed, hospital-grade line cord, (ME 7293)
6. Instruction Manual and warranty registration instructions

1.7 Limited Warranty

The Sys*Stim 228 neuromuscular electrical stimulator is warranted against defects in materials and workmanship for a period of two years from date of purchase. During the applicable warranty period Mettler Electronics Corp. will, at its discretion, either repair or replace the Product without charge for these types of defects.

For service under this warranty, the Product must be returned by the buyer within the applicable warranty period to Mettler Electronics Corp. **Shipping charges to Mettler Electronics Corp. under this warranty must be paid by the buyer. The buyer must also include a copy of the sales receipt or other proof of the date of purchase. If the Product is returned without proof of the date of purchase, it will be serviced as an out-of-warranty product at Mettler Electronics Corp.'s prevailing service rates.**

Alteration, misuse, or neglect of the Product voids this warranty. Except as specifically set forth above, Mettler Electronics Corp. makes no warranties, express or implied, including without limitation any implied warranty of merchantability or fitness for a particular purpose, with respect to the Product. If any implied warranties apply as a matter of law, they are limited in duration to one year.

Mettler Electronics Corp. shall not be liable for any indirect, special, consequential or incidental damages resulting from any defect in or use of the Product.

Any legal action brought by the buyer relating to this warranty must be commenced within one year from the date any claim arises and must be brought only in the state or federal courts located in Orange County, California.

Some states do not allow limitations on how long an implied warranty lasts, or the exclusion or limitation of incidental or consequential damages, so the above limitations or exclusions may not apply to the buyer. This warranty gives the buyer specific legal rights, and the buyer may also have other rights which vary from state to state.

Section 2—Symbol Glossary and List of Abbreviations

2.1 Symbol Glossary



Time display

○ 1

○ 2

Channel timer indicator LED's. Example: Indicator LED for channel 1 will be lit when the time displayed is for channel 1 in the 2-timer mode. Both indicators will be lit when the time displayed applies to both channels. Channel 1 or 2 LED will blink to indicate "adjust intensity for the selected channel" in the reciprocation and surge modes.



These LED's will illuminate to prompt the clinician to input either time in seconds or microseconds or frequency in Hz. The time or the frequency will be displayed in the numeric time display.



Time display LED's. Displays treatment time and numeric values for frequency, phase duration and on/off times.



Numeric keypad for time, frequency or phase duration entry.



Starts treatment, stimulation output activated.



Stops treatment in the channel displayed in timer window.



Use as the "Enter" button during treatment setup.



Stops all stimulation output from both channels.



Interferential waveform selector – LED is illuminated when this function is activated.



Premodulated waveform selector – LED is illuminated when this function is activated.

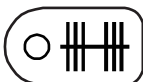

Medium frequency waveform selector – LED is illuminated when this function is activated.

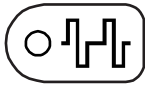

Symmetrical biphasic waveform selector – LED is illuminated when this function is activated.



Phase duration control selector – Press this button during a biphasic treatment to display phase duration.



Frequency control selector – Press this button during a biphasic treatment to display frequency.

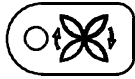

Amplitude modulation, used for interferential waveform only. LED is illuminated when this function is activated.



Stimulation output being displayed



LED's that display the output intensity during a treatment. When the unit is in the "Hold" mode, "-- --" will be displayed.

Stimulation output intensity controls – intensity may be adjusted at any time with the continuous mode for all waveforms. It may be adjusted up or down during the "On" phase of the surge and recip modes. And it may be adjusted down at any time when vector rotation is active in the interferential mode.

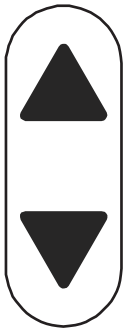

- Increase output intensity
- Decrease output intensity



Switches timer display and programming control from channel 1 to channel 2 or vice versa when the two timer option is selected (LED on).

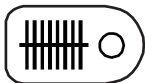

Continuous stimulation, no amplitude modulation selector – LED is illuminated when this function is activated.





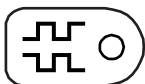

Amplitude modulation (surge) selector – Press this button during a treatment to display surge "on / off" times. LED is illuminated when this function is activated.

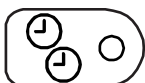

Reciprocation selector (two channels only) – Press this button during a treatment to display reciprocation "on / off" times. LED is illuminated when this function is activated.



Use two timers. Allows clinician to program two different treatment protocols under the control of two different timers. LED is illuminated when this function is activated.

-  Mains On.
-  Mains Off.
-  Caution, refer to instruction manual for directions.
-  Type BF, Applied Part
-  Prescription use only

2.2 List of Abbreviations

- cm² — square centimeters
- Hz — Hertz (pulses per second)
- LED — Light Emitting Diode
- mA — milliampere (1/1000 ampere)
- min — minutes
- ms — millisecond (1/1000 second)
- s — seconds
- S/N — Serial Number
- μs — microsecond (1/1,000,000 second)

Section 3—Installation

3.1 Installation Instructions

1. Connect the line cord to the back of the Sys*Stim 228. (See Figure 3.1)
2. Plug the line cord into a grounded wall outlet that has 115 VAC, 50/60 Hz. Your power supply must match the voltage requirements listed on the serial number label of your device. **Do not connect the Sys*Stim 228 to a power supply rated differently than that described above.**
3. The line cord comes equipped with a standard 3-prong plug. This plug provides grounding for the Sys*Stim 228. Do not defeat its purpose by using 3-to-2 prong adapters or any other means of attaching to a wall outlet.
4. The Sys*Stim 228 may be susceptible to interference originating from shortwave diathermy units operating in close proximity to it. Avoid operating the Sys*Stim 228 adjacent to and simultaneously with operating shortwave devices.
5. **Do not use sharp objects to operate the membrane panel switches.** If the tough outer layer of the membrane is broken, moisture may leak into the switches resulting in switch failure.

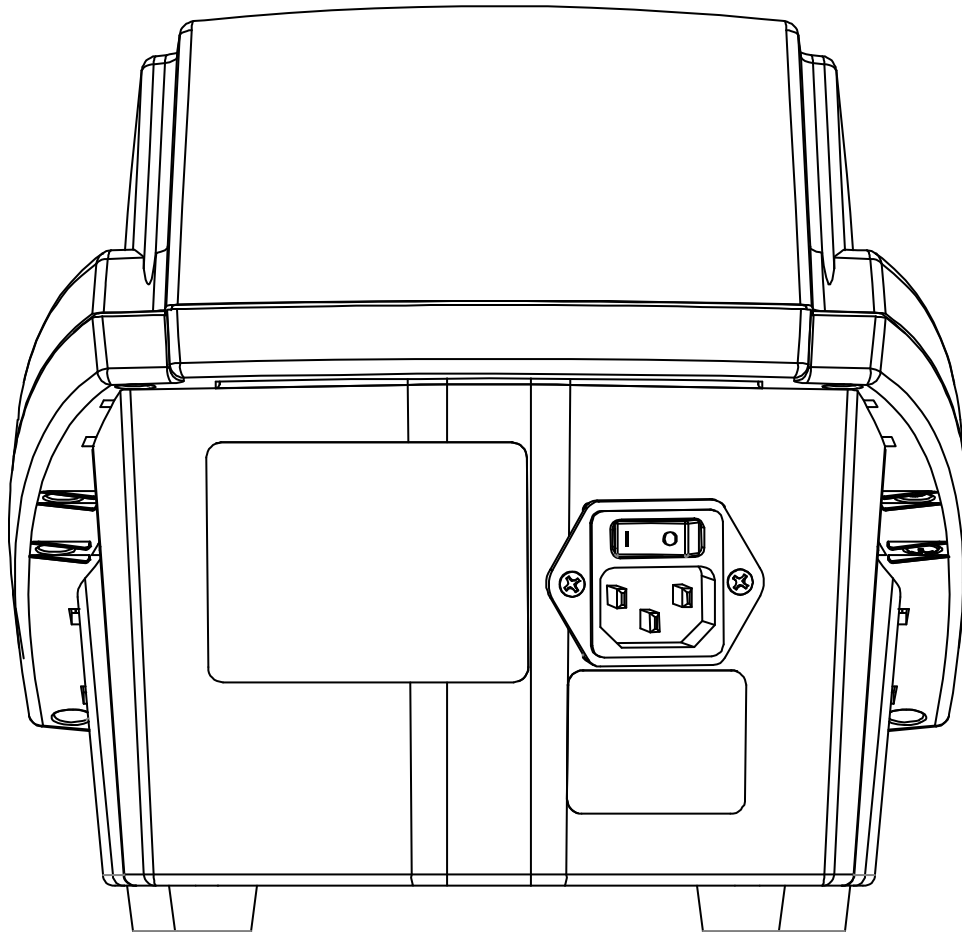

Figure 3.1 – Sys*Stim 228, Back view – Mains Power Switch and Line cord connection

3.2 EMC Guidance

CAUTION: Medical Electrical Equipment needs special precautions regarding Electromagnetic Compatibility (EMC) and needs to be installed and put into service according to the EMC information provided in the following tables.

Portable and mobile Radio Frequency (RF) communications equipment can affect Medical Electrical Equipment.

Accessories: Hospital Medical grade power cord of a maximum length of 120 inches

WARNING: The use of accessories, other than those specified, except those supplied or sold by Mettler Electronics Corp., as replacement parts for internal or external components, may result in increased EMISSIONS or decreased IMMUNITY of the Sys*Stim 228.

Guidance and manufacturer's declaration - electromagnetic emissions		
The Sys*Stim 228 is intended for use in the electromagnetic environment specified below. The customer or the user of the Sys*Stim 228 should assure it is used in such an environment.		
Emissions Test	Compliance	Electromagnetic environment-guidance
RF emissions CISPR 11	Group 1	The Sys*Stim 228 must emit electromagnetic energy in order to perform its intended function. Nearby electronic equipment may be effected.
RF emissions CISPR 11	Class B	The Sys*Stim 228 is suitable for use in all establishments other than domestic and those directly connected to the public low-voltage power supply network that supplies buildings used for domestic purposes.
Harmonic emissions IEC 61000-3-2	Applicable	
Voltage fluctuations/flicker emissions IEC 61000-3-3	Applicable	

Guidance and manufacturer's declaration - electromagnetic immunity			
The Sys*Stim 228 is intended for use in the electromagnetic environment specified below. The customer or the user of the Sys*Stim 228 should assure that it is used in such an environment.			
Immunity test	IEC 60601 test level	Compliance level	Electromagnetic environment – guidance
Electrostatic discharge (ESD) IEC 61000-4-2	±6 kV contact ±8 kV air	±6 kV contact ±8 kV air	Floors should be wood, concrete or ceramic tile. If floors are covered with synthetic material, relative humidity should be at least 30%.
Electrical fast transient/burst IEC 61000-4-4	±2 kV for power supply lines ±1 kV for input/output lines	±2 kV for power supply lines ±1 kV for input/output lines	Mains power quality should be that of a typical commercial or hospital environment.
Surge IEC 61000-4-5	±1 kV differential mode ±2 kV common mode	±1 kV differential mode ±2 kV common mode	Mains power quality should be that of a typical commercial or hospital environment.
Voltage dips, short interruptions and voltage variations on power supply input lines IEC 61000-4-11	<5% U_T (>95% dip in U_T) for 0.5 cycle 40% U_T (60% dip in U_T) for 5 cycles 70% U_T (30% dip in U_T) for 25 cycles <5% U_T (>95% dip in U_T) for 5 seconds	<5% U_T (>95% dip in U_T) for 0.5 cycle 40% U_T (60% dip in U_T) for 5 cycles 70% U_T (30% dip in U_T) for 25 cycles <5% U_T (>95% dip in U_T) for 5 seconds	Mains power quality should be that of a typical commercial or hospital environment. If the user of the Sys*Stim 228 requires continued operation during power mains interruptions, it is needed that the Sys*Stim 228 be powered from an uninterruptible power supply.
Power frequency (50/60 Hz) magnetic field IEC 61000-4-8	3 A/m	3 A/m	Power frequency magnetic fields should be at levels characteristic of a typical location in a typical commercial or hospital environment.
NOTE U_T is the A.C. mains voltage prior to application of the test level.			

Guidance and manufacturer's declaration - electromagnetic immunity

The Sys*Stim 228 is intended for use in the electromagnetic environment specified below. The customer or the user of the Sys*Stim 228 should assure that it is used in such an environment.

Immunity test	IEC 60601 test level	Compliance level	Electromagnetic environment - guidance
Conducted RF IEC 61000-4-6 Radiated RF IEC 61000-4-3	3 V _{rms} 150 kHz to 80 GHz 3 V/m 80 MHz to 2,5 GHz	3 V 3 V/m	<p>Portable and mobile RF communications equipment should be used no closer to any part of the Sys*Stim 228, including cables, than the recommended separation distance calculated from the equation applicable to the frequency of the transmitter.</p> <p>Recommended separation distance</p> $d = 1,2\sqrt{P}$ $d = 1,2\sqrt{P} \text{ 80MHz to 800 MHz}$ $d = 2,3\sqrt{P} \text{ 800MHz to 2,5 GHz}$ <p>where P is the maximum output power rating of the transmitter in watts (W) according to the transmitter manufacturer and d is the recommended separation distance in meters (m).</p> <p>Field strengths from fixed RF transmitters, as determined by an electromagnetic site survey,^a should be less than the compliance level in each frequency range.^b</p> <p>Interference may occur in the vicinity of equipment marked with the following symbol:</p> 

NOTE 1 At 80 MHz and 800 MHz, the higher frequency range applies.

NOTE 2 These guidelines may not apply in all situations. Electromagnetic propagation is affected by absorption and reflection from structures, objects and people.

^a Field strengths from fixed transmitters, such as base stations for radio (cellular/cordless) telephones and land mobile radios, amateur radio, AM and FM radio broadcast and TV broadcast cannot be predicted theoretically with accuracy. To assess the electromagnetic environment due to fixed RF transmitters, an electromagnetic site survey should be considered. If the measured field strength in the location in which the Sys*Stim 228 is used exceeds the applicable RF compliance level above, the Sys*Stim 228 should be observed to verify normal operation. If abnormal performance is observed, additional measures may be necessary, such as reorienting or relocating the Sys*Stim 228.

^b Over the frequency range 150 kHz to 80 MHz, field strengths should be less than 3 V/m.

**Recommended separation distances between
portable and mobile RF communications equipment and the
Sys*Stim 228**

The Sys*Stim 228 is intended for use in an electromagnetic environment in which radiated RF disturbances are controlled. The customer or the user of the Sys*Stim 228 can help prevent electromagnetic interference by maintaining a minimum distance between portable and mobile RF communications equipment (transmitters) and the Sys*Stim 228 as recommended below, according to the maximum output power of the communications equipment.

Rated maximum output power of transmitter W	Separation distance according to frequency of transmitter m		
	150 kHz to 80 MHz $d = 1,2\sqrt{P}$	80 MHz to 800 MHz $d = 1,2\sqrt{P}$	800 MHz to 2,5 GHz $d = 2,3\sqrt{P}$
0,01	0,12	0,12	0,23
0,1	0,38	0,38	0,73
1	1,2	1,2	2,3
10	3,8	3,8	7,3
100	12	12	23

For transmitters rated at a maximum output power not listed above, the recommended separation distance d in meters (m) can be estimated using the equation applicable to the frequency of the transmitter, where P is the maximum output power rating of the transmitter in watts (W) according to the transmitter manufacturer.

NOTE 1 At 80 MHz and 800 MHz, the separation distance for the higher frequency range applies.

NOTE 2 These guidelines may not apply in all situations. Electromagnetic propagation is affected by absorption and reflection from structures, objects and people.

Guidance and manufacturer's declaration

No.	Mode of Operation	Essential Performance Degradation Allowed
1	Unit tested to 230 VAC for CE Unit tested to 120 VAC for US/Canada	Unit designed to be failure safe in abnormal condition
2	Unit has two stim channels	Reset allowed as long as failure safe

Section 4—Operating Instructions

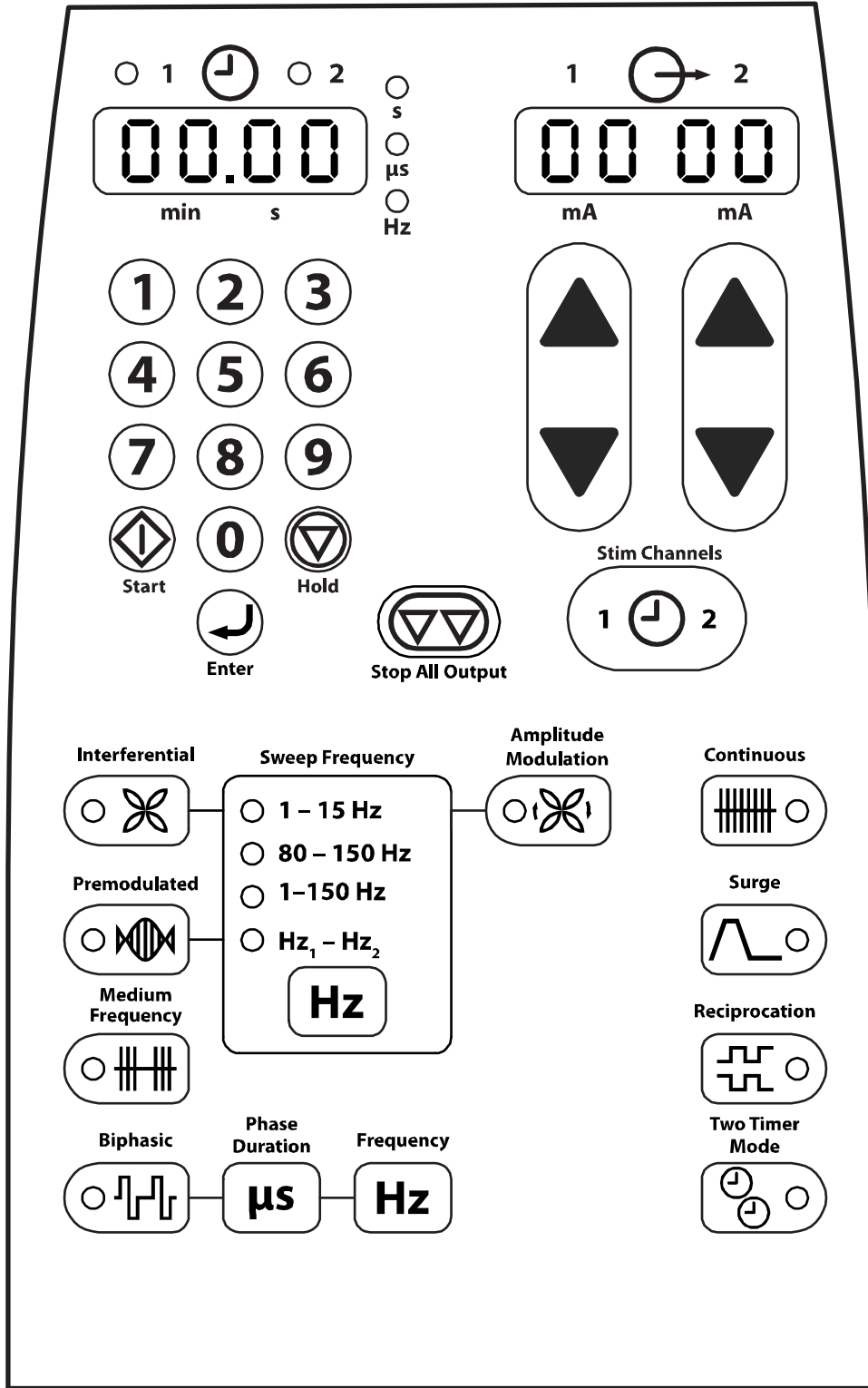

Figure 4.1 – Front membrane panel and LED indicators

4.1 A Note About Electrodes

To ensure safe operation of the Sys*Stim 228, follow the recommendations listed below:

1. We strongly encourage careful maintenance of the electrode system. This includes the lead wires as well as the pads themselves. Worn cables and/or poor pads (or the wrong sized pads) can have a significant impact upon treatment results.
2. Do not exceed the number of recommended uses listed on the instructions for EZ Trodes or other reusable self-adhesive electrodes.
3. Make sure that the entire surface of the electrode is contacting the patient.
4. Do not use moist hot packs to secure electrodes.
5. To avoid skin irritation due to high current density, do not use electrodes smaller in surface area than the 2" in diameter EZ Trode[®] self-adhesive electrode (ME 2221).
6. Do not use conductive carbon electrodes with this product.
7. Whenever clinically possible, utilize the largest possible pads to reduce local increases in current density. In situations where small pads are required, use the lowest stimulation intensity necessary to achieve the desired clinical results.

The table below illustrates the relationship between electrode diameter and current density. As you can see the current density increases rapidly when diameter decreases.

Diameter <i>inches</i>	Surface Area <i>Square inches</i>	Current Density <i>mA/sq in (for 10mA)</i>
1.25	1.2	8.2
2.00	3.1	3.2
3.00	7.1	1.4

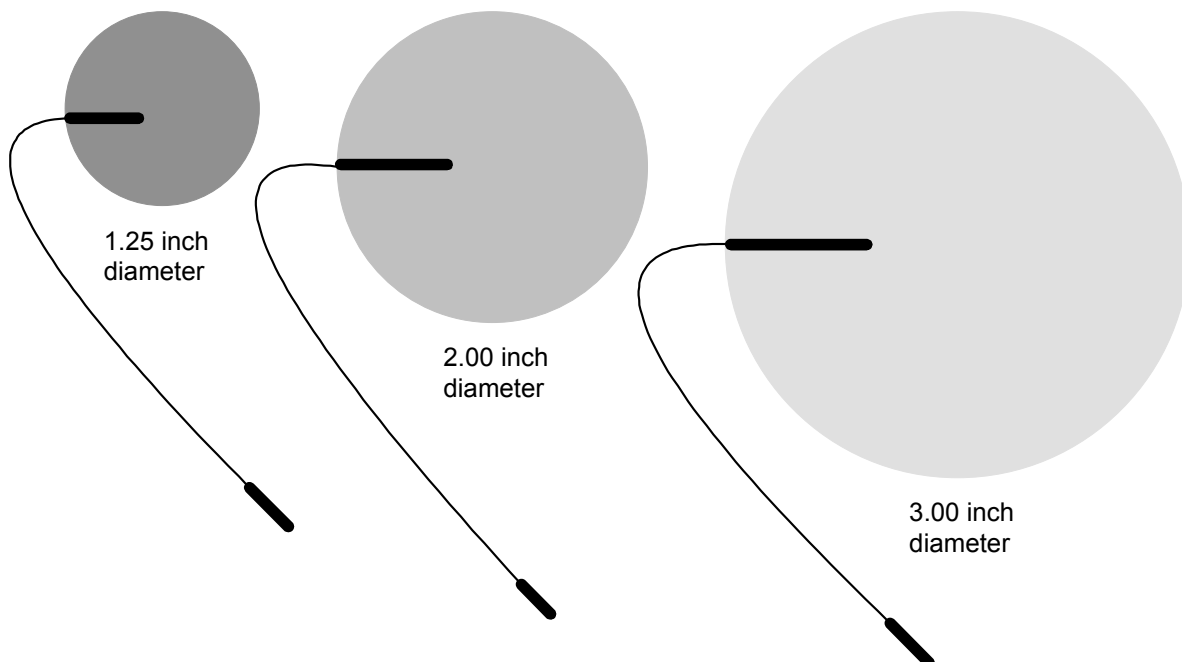

Figure 4.2 – Electrode Sizes and Current Density

4.2 General Operating Instructions:

Before you start:

- a) Review precautions, contraindications and side effects/adverse reactions listed in Section 5.
- b) Use Mettler Electronics electrodes to ensure safe and effective operation.
- c) Verify connection of the line cord to a grounded wall receptacle and the Sys*Stim 228.
- d) Note: Descriptions of the symbols used on controls are in Section 2.



1. Turn on the mains power switch by pressing “I” icon on switch.
2. Insert the connectors attached to the electrode cables (ME 2280) into the electrode cable receptacles illustrated on the left.
3. Attach electrodes to electrode cables. Apply the electrodes to the patient after reviewing “A Note about Electrodes”.

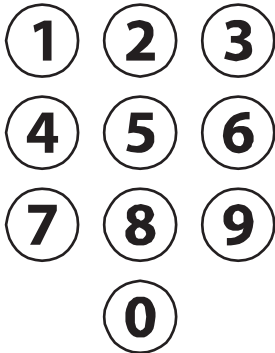
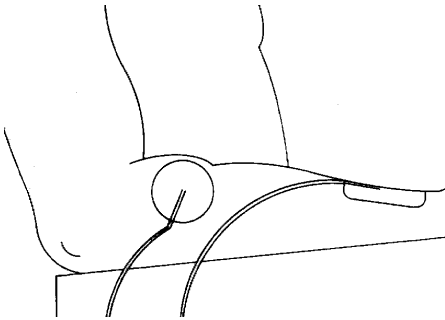

4. Select the desired treatment time by pressing a number(s) on the numeric keypad. Unit beeps when a button is pressed. Only whole minutes may be selected. Treatment times from 1 to 60 minutes are valid. Time is displayed in the time window. During a treatment time remaining is displayed in minutes and seconds.

To treat without a set time, do not enter a time value. The timer will count up to indicate time elapsed since the beginning of the session.

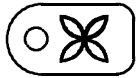

• Interferential



• Premodulated
(Bipolar)

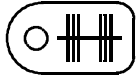

• Medium
Frequency
(Russian)



• Biphasic

5. Select the waveform for this treatment session. The default waveform is the interferential waveform.

6. Set treatment phase duration (*biphasic only*) and frequency. Please note: *Medium frequency has a fixed phase duration and frequency so no adjustments are necessary.*

Sweep Frequency

- Interferential
- Premodulated (Bipolar)

1 – 15 Hz
 80 – 150 Hz
 1–150 Hz
 Hz₁ – Hz₂

Hz

150

Hz

Phase Duration

- Biphasic

μs

250

μs

Frequency

Hz

80

Hz

- Select frequency modulation for *the Interferential or Premodulated* modes by pressing the button labeled “Hz” until the LED to the left of the desired selection is illuminated. For “Hz₁-Hz₂” input any value from 0–250 for Interferential mode or 1–250 for Premodulated mode using the numeric key pad and then press “Enter”. Repeat the same procedure for the second frequency in the range. For a fixed treatment frequency, input the same value twice.

- Select phase duration in μs. Enter any value from 50–300 μs using the numeric key pad and then press “Enter”. The Sys*Stim 228 stores the value of the last phase duration used and displays it in the timer window. If the displayed value is the one you want either press “Enter” or the button labeled “μs”.

- Select frequency in Hz. Enter any value from 1–120 Hz using the numeric keypad and then press “Enter”. The Sys*Stim 228 stores the value of the last frequency used and displays it in the timer window. If the displayed value is the one you want either press “Enter” or the button labeled “Hz”.

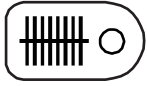

• Continuous

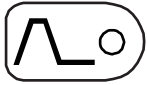

• Surge

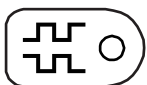

• Recip

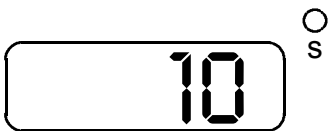

7. Select the amplitude modulation method for this treatment session for the Premodulated, Medium Frequency and Biphasic modes only. The default is continuous.

⇒ **Surge Mode**

- Press the “Surge” button to select on and off times. The up and down ramps are fixed to 3 seconds up and 2 seconds down. The preset on/off times (*in seconds*) are: 10 on/10 off, 10 on/20 off, 10 on/30 off, 10 on/40 off, 10 on/50 off and 10 on/60 off. On/Off times are displayed in the timer window.
- Continue pressing the “Surge” button until the desired on/off time is displayed in the timer window. Then Press “Enter” to enter that on/off time.
- To select a custom on/off time, press the “Surge” button one more time after “10 60” is displayed. A single number is displayed in the timer window. This is the on time. Use the numeric keypad to select an on time in seconds from 1 to 240. Press “Enter” to enter the on time. A second single number is displayed in the timer window. This is the off time. Use the numeric keypad to select an off time in seconds from 1 to 240. Press “Enter” to enter the off time.
- To review an on/off time during a treatment, press the “Surge” button. Surge on/off time will be displayed briefly in the timer window.

⇒ **Reciprocation Mode**

- Press the “Reciprocation” button to select reciprocation times between channels one and two. The up and down ramps are fixed at 1 second. A single number is displayed in the timer window. Use the numeric keypad to select a reciprocation time in seconds from 2 to 240. Press “Enter” to enter the reciprocation time. Each channel will be on and off for the time set in a reciprocal fashion.
- To review an on/off time during a treatment, press the “Reciprocation” button. Reciprocation time will be displayed briefly in the timer window.
- For reciprocation with unequal on and off

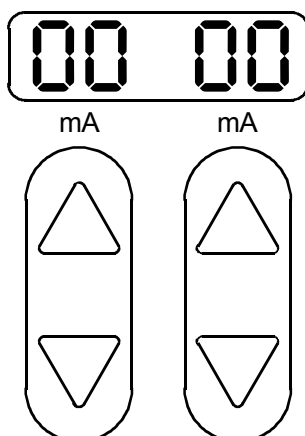
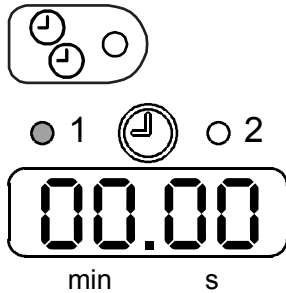

times first press the reciprocation button and then press “Enter”. Press the surge button and then follow the instructions to set on/off times in the surge mode. First channel one will be on for the set on time and then channel two will come on during the set off time.

- To review an on/off time during a treatment, press the “Reciprocation” button. Reciprocation time will be displayed briefly in the timer window.

8. Use the two timer option to use two different treatment protocols or two different treatment times simultaneously. Individual treatments can be setup, started and stopped independently. This option is available with the premodulated, medium frequency and biphasic modes. Use the two timer mode with the “Continuous” and “Surge” amplitude modulation options. The indicator LED will be lit for the channel that is being displayed at any one time. Program the single channel just like you would program the Sys*Stim 228 for two-channel operation.



- To switch between the two channels either during setup or during a treatment press the button shown at the left. The time and the treatment protocol are displayed for the channel whose indicator LED is lit.

9. Press  after all treatment parameters have been set to begin treatment.

10. “-- --” is displayed in the mA display followed by double zeroes indicating that the channels are active. *In the two timer mode of operation, the active channels will display 00's. If either channel is off its display will show “--”.* Press the “Up” or “Down” arrows to adjust treatment intensity. The numbers in the display will increase as the “Up” arrow is depressed. If you press an arrow one time the intensity will increase or decrease in small increments. If you hold an arrow down, the Sys*Stim 228 will beep three times and then the intensity will increase rapidly until the button is released.

- In the “Surge” mode, the Sys*Stim 228 allows you to adjust the treatment intensity before beginning the “On/Off” cycle that you selected. The green LED's above the time window will blink on and off to alert you to adjust treatment intensity. Use

the “Up” or “Down” arrows for both channels to adjust intensity to the desired level. Then press  again to initiate the treatment cycle. The intensity may be adjusted only during the “On” part of the “Surge” cycle.

- In the “Reciprocation” mode, The Sys*Stim 228 will prompt you to adjust the intensity in Channel 1. Once you have made the adjustment press . You will then be prompted to adjust the intensity in Channel 2 by the flashing LED for that channel. Adjust the intensity and then press . The mA in Channel 2 will ramp down and the reciprocation mode will begin cycling with Channel 1 active first. Again, the output intensity in mA is displayed in the output window.
- In the “two timer” mode the LED above the channel that is active will be on or blinking to guide you through adjusting the treatment intensity.



11. In the “Interferential” mode you may choose to activate the vector control button after the intensities for both channels have been set to patient comfort. *It is not recommended that you adjust the intensity level to **tolerance**, since the field moves within the tissues and some areas may be more sensitive than others..* You will also notice that the intensity level of one channel increases by 50% while the intensity level of the other channel decreases by 50%. The intensity of the combined channels however, remains constant.

After you engage the vector control button, you can adjust the treatment intensity *down* at any time. You can adjust the intensity up, only at the peak for that channel. By adjusting the intensity in either channel, you can change the interferential field to target the area being treated.



“Single” Hold



“Stop”

12. Press either of these two buttons to hold treatment at any time and stop all output to the patient. Time remaining or time elapsed will display in the timer window. “-- --” will display in the output window.
 - In the single timer mode, both buttons will stop treatment in both channels.
 - In the “Two timer” mode, pressing the “single hold” button stops treatment only for the channel indicated by the illuminated green LED above the time window.

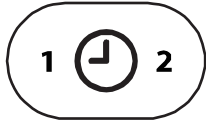

- In the “Two Timer” mode, pressing the “stop” button stops treatment in both channels.

13. In the “Two Timer” mode, use this button to either program or view the time remaining for the other channel. The output display remains active for both channels regardless of which channel is selected by this control.

14. At the end of treatment, the Sys*Stim 228 will beep three long beeps to indicate the end of treatment. The output to the patient will stop. The timer display will show “00.00” and the mA display will show “---”.

4.3 Electrode Positioning

1. General information

Placement of electrodes may be by the quadpolar, bipolar or monopolar techniques. Proper positioning and contact will insure treatment comfort and efficiency. Electrodes should never be placed in such a manner as to produce current flow through the cardiac area. For safe operation of the Sys*Stim 228, review contraindications, warnings, precautions and Side Effects/ Adverse Reactions in sections 5.2, 5.3, 5.4 and 5.5 before positioning electrodes.

2. Preparation of the skin prior to electrode application

To insure the efficient current conduction necessary for proper treatment, certain preparations must be made. Cleaning or wetting should eliminate any impairment to current conduction on the patient’s skin such as an oily or dry surface, or excessive hair coverage. Shaving may be necessary depending upon the density of hair coverage. **Failure to provide for maximum current conduction efficiency could result in skin irritation relating to an increase in current density at the electrode site.**

Using reusable electrodes for longer periods of time than those recommended by the package insert could result in ineffective treatments or cause skin irritation. Care should be taken to ensure application of the total electrode surface area to the patient's skin prior to commencing treatment.

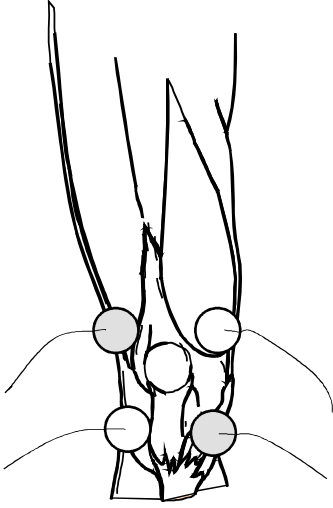

Figure 4.3 – Quadpolar Electrode Placement Technique

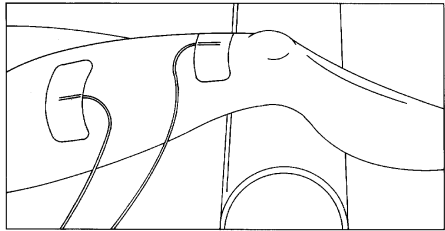

Figure 4.4 – Bipolar Electrode Placement Technique

3. Quadpolar electrode application technique

Quadpolar techniques should be used with the “Interferential” waveform. The electrodes from Channel 1 are placed diagonally from each other. While the electrodes from Channel 2 are placed diagonally across from each other to form an “X” over the treatment area. The zone of maximum interference between the two channels occurs roughly in the center of the “X”.

Adjusting the intensity levels of the two channels will change the apparent interference pattern felt by the patient. Pressing the “Vector, amplitude modulation” control during treatment will modulate the intensity of the outputs of the two channels during treatment, increasing the area covered by the interference pattern.

4. Bipolar electrode placement techniques

Bipolar electrode placement techniques should be used to provide stimulation to larger muscle groups, such as the quadriceps or the hamstrings. The symmetrical waveforms of the “Premodulated”, “Medium Frequency” and “Biphasic” waveforms are usually applied to the body using the bipolar technique.

Equal size electrodes are placed at each end of the muscle or muscle group. Current concentration is over the entire length of that muscle or muscle group and especially effective on weak musculature. Electrode placement should be at opposite ends of the limb or muscle group. Care should be taken to insure that electrodes are not placed too close together which could produce current concentration along the edges of the pads. This is the so-called “edging effect” which can cause patient discomfort. The figure on the left shows a pad set up for stimulation of the quadriceps.

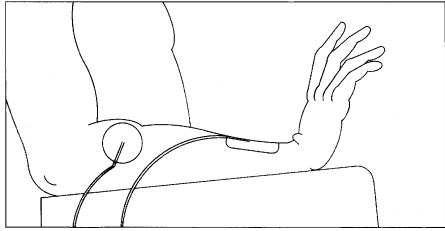

Figure 4.5 – Monopolar Electrode Placement Technique

5. Monopolar electrode application techniques

Monopolar techniques may be used with the “Premodulated”, “Medium Frequency” and “Biphasic” waveforms. The smaller, active, electrode (black and negative) is placed over the muscle motor point. In treatments designed to relieve pain, the active electrode is placed over the painful area. The larger, dispersive, electrode (red and positive) is placed on the same side of the body at some point distal to the active electrode. The dispersive pad is generally three to four times larger than the active electrode so that current density is too low to cause muscle contractions under the dispersive electrode. Never place the dispersive electrode over the antagonist muscle.

The monopolar electrode placement technique has been found to be especially useful for muscle stimulation of the upper extremities and small muscle groups. This technique helps concentrate the stimulation effect on the muscle under the smaller electrode. The figure on the left illustrates one possible electrode placement for muscle stimulation of the forearm.

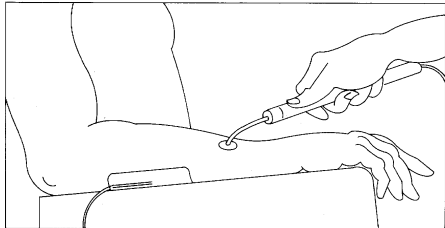

Figure 4.6 – Using the Pencil Electrode

6. Using the pencil electrode

The pencil electrode is used for the stimulation of small muscles or painful areas. It is also useful to help identify the exact motor point of a muscle or muscle group. The pencil electrode may be used with the “Premodulated”, “Medium Frequency” or “Biphasic” waveforms.

Attach the pencil electrode to the black electrode cable using a pin to banana adapter. Attach the red electrode cable to a dispersive pad. Apply dispersive electrode in such a manner to prevent transthoracic stimulation

Pressing the switch located on the pencil electrode will allow treatment currents to be delivered to the patient. Four tips of different sizes are included with the pencil electrode. The figure on the left shows an application of the pencil electrode.



7. Additional information about electrode placement:

Motor point charts are available as guides from Mettler Electronics Corp. These points may vary from patient to patient, and at time of injury, may vary in the same patient. “Functional Electrical Stimulation - A Practical Clinical Guide” by Benton, Baker, Bowman and Walters: published by Rancho Los Amigos of Downey, California is an excellent guide for electrode placement for muscle stimulation. “Clinical Transcutaneous Electrical Nerve Stimulation” by Mannheimer and Lampe is a good source for electrode placement techniques for pain management.

4.4 Combination Therapy Using the Sys*Stim 228 and the Sonicator

Application of simultaneous therapeutic ultrasound and electrical neuromuscular stimulation can be accomplished using the pulsed waveforms from the Sys*Stim 228 with a Sonicator therapeutic ultrasound unit from Mettler Electronics Corp.

In this technique, the ultrasound applicator delivers the ultrasonic energy and becomes the active electrode for muscle stimulation. **WARNING:** Apply dispersive electrode in such a manner to prevent transthoracic stimulation. Follow the instructions below to administer combination therapy.

Instructions for Combination Therapy:

Combination therapy may be performed by plugging in the black lead wire with a pin to banana adapter attached into the receptacle on the bottom of the Sonicator 705, 706, 715, 716, 710, 720, 730 or 740. The other lead wire from the same channel is attached to a treatment electrode, which is then applied to the patient to complete the electrical circuit. (Avoid transthoracic stimulation!) When electrical output is generated by the Sys*Stim 228, it will be passed through the metal ring on the Sonicator applicator.

NOTE: It is necessary to use a preparation such as Sonigel, which conducts both electric currents as well as ultrasonic energy, as a couplant for combination therapy. Non conductive materials such as mineral oil are not suitable for this application.

It is not necessary to input time on the Sys*Stim 228. The Sonicator controls all timing. Do not use the “Interferential” mode for combination therapy. Place the Sys*Stim 228 into the “Continuous” mode. When all treatment parameters have been set on both units, press “⏏” on the Sys*Stim 228. Apply the ultrasound applicator to the gelled treatment area on the patient and adjust the stimulation intensity on the Sys*Stim 228. Then press “Go” on the Sonicator and adjust ultrasound output on the Sonicator intensity control. When the selected time has elapsed on the Sonicator and the end-of-treatment buzzer sounds, press “Hold” on the Sys*Stim 228 before removing the applicator from the patient to stop electrical stimulation output.

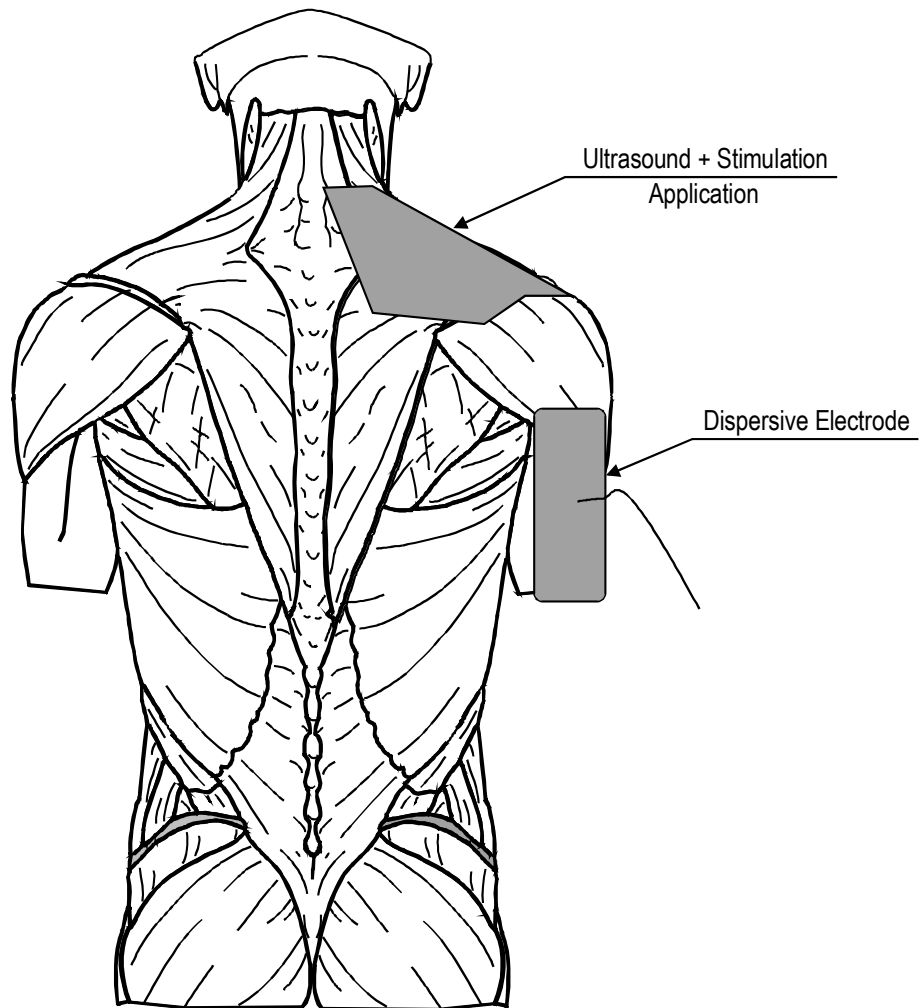

Figure 4.7 – Application of Combination Therapy

Section 5—

Indications, Contraindications, Precautions and Adverse Reactions

5.1 Indications

The application of pulsating electric currents to the body via electrodes elicits responses from nerves, which conduct pain sensation and muscle contraction information. Stimulation of sensory fibers will help block pain while the stimulation of motor fibers will generate pulsatile contractions of the muscle groups innervated by the nerves being stimulated.

Based on this information, some of the indications for use are as follow:

1. Symptomatic relief of chronic intractable pain, acute post traumatic pain or acute post surgical pain (*Interferential or Premodulated waveforms*)
2. Temporary relaxation of muscle spasm
3. Prevention of post-surgical phlebo-thrombosis through immediate stimulation of calf muscles
4. Increase of blood flow in the treatment area
5. Prevention or retardation of disuse atrophy in post-injury type conditions
6. Muscle re-education
7. Maintaining or increasing range of motion

5.2 Contraindications

1. Powered muscle stimulators should not be used on patients with cardiac demand pacemakers.
2. Do not use this device on patients who have a cardiac pacemaker, implanted defibrillator, or other implanted metallic or electronic device, because this may cause electric shock, burns, electrical interference, or death.
3. Do not use this device on patients whose pain syndromes are undiagnosed.
4. Do not use electrical stimulation in conjunction with high frequency surgical equipment or microwave or shortwave therapy systems.

5.3 Warnings

1. The long-term effects of chronic electrical stimulation are unknown.
2. Stimulation should not be applied over the carotid sinus nerves, particularly in patients with a known sensitivity to the carotid sinus reflex.
3. Stimulation should not be applied over the neck or mouth. Severe spasm of the laryngeal and pharyngeal muscles may occur and the contractions may be strong enough to close the airway or cause difficulty in breathing.

4. Stimulation should not be applied transthoracically in that the introduction of electrical current into the heart may cause cardiac arrhythmias.
5. Stimulation should not be applied transcerebrally.
6. Stimulation should not be applied over swollen, infected, or inflamed areas or skin eruptions, e.g., phlebitis, thrombophlebitis, varicose veins, etc.
7. Stimulation should not be applied over, or in proximity to, cancerous lesions.
8. Consult with the patient's physician before using this device, because the device may cause lethal rhythm disturbances to the heart in susceptible individuals.
9. Apply stimulation only to normal, intact, clean, healthy skin.
10. Do not apply stimulation in the presence of electronic monitoring equipment (e.g., cardiac monitors, ECG alarms), which may not operate properly when the electrical stimulation device is in use.

5.4 Precautions

1. Care should be taken in the treatment of patients receiving another type of Safety of powered muscle stimulators for use during pregnancy has not been established.
2. Caution should be used for patients with suspected or diagnosed heart problems.
3. Caution should be used for patients with suspected or diagnosed epilepsy.
4. Caution should be used in the presence of the following:
 - a. When there is a tendency to hemorrhage following acute trauma or fracture;
 - b. Following recent surgical procedures when muscle contraction may disrupt the healing process;
 - c. Over the menstruating or pregnant uterus; and
 - d. Over areas of the skin which lack normal sensation.
5. Some patients may experience skin irritation or hypersensitivity due to the electrical stimulation or electrical conductive medium. The irritation can usually be reduced by using an alternate conductive medium or alternate electrode placement.
6. Electrode placement and stimulation settings should be based on the guidance of the prescribing practitioner.
7. Powered muscle stimulators should be kept out of the reach of children.
8. Powered muscle stimulators should be used only with the leads and electrodes recommended for use by Mettler Electronics Corp.
9. TENS is not effective for pain of central origin, including headache.
10. TENS is not a substitute for pain medications and other pain management therapies.
11. TENS devices have no curative value.
12. TENS is a symptomatic treatment and, as such, suppresses the sensation of pain that would otherwise serve as a protective mechanism.
13. The long-term effects of electrical stimulation are unknown.
14. Since the effects of stimulation of the brain are unknown, stimulation should not be applied across the head, and electrodes should not be placed on opposite sides of the head.

15. It is advisable to insulate patients, preferably by use of a wooden treatment table or one that is completely padded by non-conductive material. Added safety is provided if the patient cannot touch any grounded metal parts.
16. Limit treatment intensity to 50 mA (50 V) or less, when using small electrodes (2" diameter), to reduce the chance of thermal burns due to high current density. Avoid current densities exceeding 2 mA/cm² when using this device.
17. Turn on the stimulator before applying electrodes to the patient.

5.5 Side Effects/Adverse Reactions

1. Skin irritation and burns beneath the electrodes have been reported with the use of powered muscle stimulators.
2. Possible allergic reactions to tape, gel or electrodes may occur.
3. Patients may experience headache and other painful sensations during or following the application of electrical stimulation near the eyes and to the head and face.

Section 6—Maintenance and Troubleshooting

6.1 Cleaning the Sys*Stim 228

1. The Sys*Stim 228 can be wiped off with a damp cloth. The power cord should be disconnected from the unit before this is done. In the case of stubborn dirt a gentle household cleaner can be sprayed on the cloth and then wiped on the unit. If this method is used, remove any cleaner residue with a damp cloth. Do not spray cleaner into the vents of the unit.
2. Follow the EZ Trode package insert for the use and care of the electrodes supplied with the Sys*Stim 228.
3. For routine cleaning of the electrode cables use soap and water. Thoroughly dry after cleaning.

6.2 Routine Maintenance

1. Standard medical electrical safety checks should be performed annually by qualified biomedical engineers or technicians trained to perform these procedures.
2. Inspect electrode cables and associated connectors for damage.

6.3 Troubleshooting the Sys*Stim 228

Symptom	Action
1. Nothing lights when main power switch is turned on.	Is line cord connected to outlet? Does the outlet have power? Unit may require servicing if none of the above resolves the problem.
2. "E_01" displayed in Time window.	Computed checksum for EPROM microcode is in error. Unit requires servicing.
3. "E_02" displayed in Time window.	Communication error between main microprocessor and waveform generator microprocessor. If powering unit OFF and restarting does not remove error, unit requires servicing.
4. "E_03" displayed in Time window.	Output voltage error, deviation from preset or expected value. If powering unit OFF and restarting does not remove error, unit requires servicing.

5. “E_05” displayed in Time window.

Output overcurrent detected. Current exceeded 70 mA RMS for interferential, 55 mA for premodulated, and medium frequency or 105 mA peak for biphasic.

Reposition electrodes farther apart. Remove any moisture or gel from between the electrodes and try again. If error persists even without a patient connection or load, unit requires servicing.
6. “E_07” displayed in Time window.

Inadequate patient connection – patient connection impedance is increasing because the electrodes are drying out or lifting from the patient or there is an inadequate connection to the electrode cables.

In the continuous treatment modes the output voltage is reduced while the unit monitors the impedance of the patient connection. If the unit is in amplitude modulated modes, such as recip or surge, this patient connection error causes the unit to go into the HOLD mode.

All patient connection errors should be investigated to determine their cause.
7. “FF08” displayed in Time window.

If this error code is displayed when you turn on the unit, it indicates an error in the output channel test. This test includes testing of the output relays. Turn off the power to the unit and turn it back on. If the Sys*Stim 228 continues to display this error code, remove the electrode cables from the unit and turn the unit off and then back on again. If the Sys*Stim continues to display this error code, it requires service.

If the “FF08” does not display, then reattach the electrode cables and turn on the unit. If the error code reoccurs then the impedance is too low in the electrode cable circuit. Check to see if the electrodes are touching each other. If not, call for additional assistance.
8. “FF01” through “FF07” displayed in Time window.

The Sys*Stim 228 may require service. Call for additional information.

If problem is not addressed above, or if additional troubleshooting guidance is desired, call (800) 854-9305 or you may email Mettler’s Service Department at service@mettlerelectronics.com.

The distributor who sold the Sys*Stim 228 should be able to assist you with a loaner unit during warranty service.

Section 7—References

1. Bélanger A: Therapeutic Electrophysical Agents: Evidence Behind Practice, Williams and Wilkins, A Walters Kluwer Business, 2010.
2. Cohn JC and Mullin C: Neuromuscular Applications for Electrical Stimulation, from Physical Agents for the Physical Therapist Assistant, FA Davis Company, 1996.
3. Gillespie CA: Foundations for Electrical Stimulation, from Physical Agents for the Physical Therapist Assistant, FA Davis Company, 1996.
4. Hooper PD: Physical Modalities-A Primer for Chiropractic, Williams & Wilkins, 1996
5. Kenna KM: Pain Management with Electrical Stimulation, from Physical Agents for the Physical Therapist Assistant, FA Davis Company, 1996.
6. Knight KL and Draper DO: Electrotherapy from Therapeutic Modalities: The Art and Science, Lippincott Williams & Wilkins, a Wolters Kluwer business, 2008.
7. Mehreteab TA, Weisberg J and Nelson A: Electrotherapy from Physical Agents: A Comprehensive Text for Physical Therapists, Appleton & Lange, 1994.
8. Mullin D and Gardner ER: Physiologic Basis of Electrical Stimulation, from Physical Agents for the Physical Therapist Assistant, FA Davis Company, 1996.
9. Prentice W: Therapeutic Modalities: For Sports Medicine and Athletic Training, Mc Graw Hill Companies, 2008.
10. Shapiro s: Electrical Currents from Rehabilitation: From Research to Practice, Elsevier, 2008.
11. Sparrow KJ: Electrotherapeutic Modalities: Electrotherapy and Iontophoresis, from Modalities for Therapeutic Intervention (Contemporary Perspectives in Rehabilitation), F.A. Davis Company, 2005.
12. Starkey C: Electrical Agents, from Therapeutic Modalities, FA Davis Company, 1999.
13. Stillwell GK: Electrotherapy from Krusen's Handbook of Physical Medicine and Rehabilitation, W.B. Saunders Company, 1982.

This manual has been written as a guideline for the correct use of the Sys*Stim 228. Reading the above references will provide a more complete understanding of the correct applications of neuromuscular electrical stimulation.

Section 8—Specifications

8.1 General Specifications:

Input:	115 VAC \pm 10%, 50/60 Hz, 0.4 Amp Nom.
Weight:	4.8 pounds
Dimensions:	4.3 in (H) x 6 in (D) x 13.4 in (L)
Operating Temperature:	+50°F to +131°F
Humidity:	Operating, 30% to 75% Relative Humidity at 104°F Nonoperating, up to 90% Relative Humidity at 149°F
Storage Temperature:	-40°F to 167°F
Treatment timer: Indicator:	Treatment time counts down to zero when time is set, or up to 60 minutes when no time is set. The digital timer indicates time in minutes and seconds. The timer also indicates the remaining or elapsed treatment time during the "Hold" period.
Accuracy:	\pm 5%
Maximum treatment time:	60 minutes

8.2 Waveform Specifications:

Interferential Mode

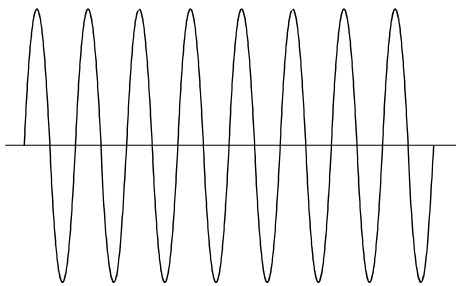

Figure 8.1 – Interferential Waveform

Waveform Type:	Sinewave
Volts:	0–65 volts RMS, 1 Kohm load
Current:	0–65 mA RMS, 1 Kohm load
Average current at maximum intensity and frequency:	65 mA RMS
Maximum current density under 2" diameter electrode.	3.2 mA/cm ²
Frequency:	Channel 1 = 4000 Hz Channel 2 = 4000 to 4250 Hz variable frequency sine wave
Frequency Modulation:	1–15 Hz 80–150 Hz 1–150 Hz xx–xx Hz, <i>xx=any value from 1 to 250 Hz</i>

Phase Duration:	125 μ s
Available Amplitude	
Modulation Options:	Vector rotation
Two Timer Option:	No

Premodulated Mode

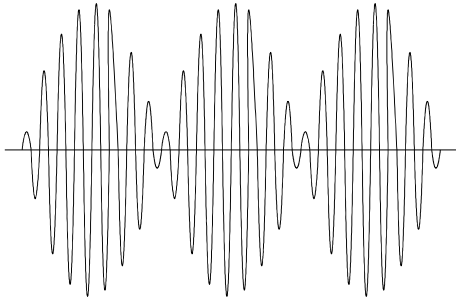

Figure 8.2 – Premodulated Waveform

Waveform Type:	Amplitude modulated sine wave
Volts:	0-50 volts RMS, 1 Kohm load
Current:	0-50 mA RMS, 1 Kohm load
Average current at maximum intensity and frequency:	50 mA RMS
Maximum current density under 2" diameter electrode.	2.5 mA/cm ²
Frequency:	4,000 Hz
Frequency Modulation:	1-15 Hz 80-150 Hz 1-150 Hz xx-xx Hz, <i>xx=any value from 1 to 250 Hz</i>
Phase Duration:	125 μ s internal sine wave 4-1,000 ms beat envelope
Available Amplitude	
Modulation Options:	Continuous Surge Reciprocation
Two Timer Option:	Yes

Medium Frequency Mode

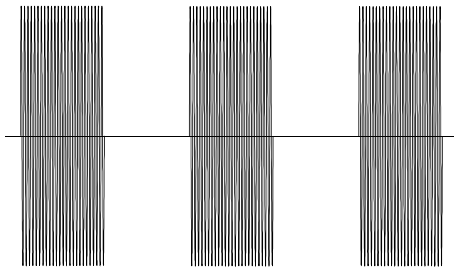

Figure 8.3 – Medium Frequency (Russian) Waveform

Waveform Type:	Burst modulated sine wave
Volts:	0–50 volts RMS, 1 Kohm load
Current:	0–50 mA RMS, 1 Kohm load
Average current at maximum intensity and frequency:	50 mA RMS
Maximum current density under 2" diameter electrode.	2.5 mA/cm ²
Frequency:	2500 Hz, Burst at 10 ms on and 10 ms off
Frequency Modulation:	No
Phase Duration:	200 μs
Available Amplitude Modulation Options:	Continuous Surge Reciprocation
Two Timer Option:	Yes

Biphasic Mode

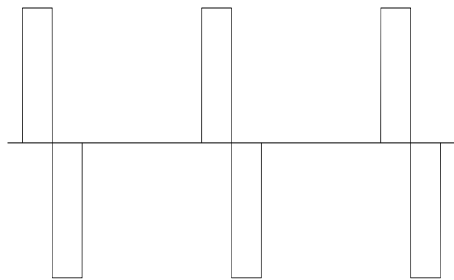

Figure 8.4 – Biphasic Waveform

Waveform Type:	Symmetrical biphasic square wave
Volts:	99 volts peak, 1 Kohm load
Current:	0 –99 mA peak, 1 Kohm load
Average current at maximum intensity and frequency:	7.2 mA
Maximum current density under 2" diameter electrode.	0.36 mA/cm ²
Frequency:	1–120 Hz
Frequency Modulation:	No
Phase Duration:	50–300 μs
Available Amplitude Modulation Options:	Continuous Surge Reciprocation
Two Timer Option:	Yes

8.3 Amplitude Modulation Specifications:

Vector rotation:	<i>Interferential Mode Only,</i>
	±50% amplitude modulation in anti phase with an eight second modulation period.
Two timer option	No
Surge Mode:	<i>Premodulated, Medium Frequency and Biphasic Pulsed Modes</i>
Up ramp:	3 seconds
Down ramp:	2 seconds
Preset on/off times:	10 seconds on, 10 seconds off 10 seconds on, 20 seconds off 10 seconds on, 30 seconds off 10 seconds on, 40 seconds off 10 seconds on, 50 seconds off 10 seconds on, 60 seconds off
Programmable On time:	1-240 seconds
Programmable Off time:	1-240 seconds
Two timer option:	Yes
Reciprocation mode:	<i>Premodulated, Medium Frequency and Biphasic Pulsed Modes</i>
Up and down ramps:	1 second, <i>reciprocation only</i>
Reciprocation time:	2-240 seconds, (On time = off time)
Combine with Surge:	Use up and down ramps of surge program Use on/off times of surge program.
Two timer option:	No

Section 9—Accessories

9.1 Ordering Information:

Therapy products and accessories are available from Mettler Electronics authorized Distributors. For information regarding either Mettler products or a distributor near you, please call toll free, (800) 854-9305 or phone (714) 533-2221 in areas outside the continental United States. Ask for Customer Service. Mettler Electronics is open from 7 AM until 5 PM Pacific Time for your convenience.

9.2 Sys*Stim 228 Accessories

Catalogue #	Item Description
110	Travel bag – Ideal for carrying the Sys*Stim to the patient. Holds one Sys*Stim 228 and its accessories
1844	Sonigel – salt free colloidal water couplant, case of 12, 9.5 oz. tubes
1851	Sonigel clear gel couplant, (12 x 250 ml bottles)
1852	Sonigel clear gel couplant, (1 x 5 liters)
1853	Sonigel clear gel couplant, (4 X 5 liters)
1861	Sonigel – clear gel couplant, case of 4 boxes of 1851
1863	Sonigel Lotion with Aloe Vera (1 X 1 G), pump included with each gallon container
1864	Sonigel Lotion with Aloe Vera (4 cases x 1863)
2000	4 Sponge electrodes (2" x 2")
2001	24 Sponge inserts (2" x 2")
2002	4 Sponge electrodes (4" x 4")
2003	24 Sponge inserts (4" x 4")
2004	1 Sponge electrode (3.5" x 7")
2005	12 Sponge inserts (3.5" x 7")
2006	1 Sponge electrode (8" x 10")
2007	12 Sponge inserts (8" x 10")
2008	4 Electrode straps (24")
2009	4 Electrode straps (48")
2023	Pencil electrode set with push button stimulation control, (includes handle, 4 different sizes of stainless steel spot electrode tips, and carrying case)
2027	Pin to banana adapter plug set to be used with ME 2026, 2260 or 2201 electrode cables. Four each, gray.
2030	Bifurcation cable set, 2 cables, one red and one black, pin termination

2260	Electrode cable for the Sys*Stim 228 with pins
2221	EZ Trode - 2" diameter round self-adhering, reusable electrodes with lead wires; case of ten packages (four electrodes/pkg.)
2222	EZ Trode - 2.75" diameter round self-adhering, reusable electrodes with lead wires; case of ten packages (four electrodes/pkg.)
2223	EZ Trode - 2" x 5" self-adhering, reusable electrodes with lead wires, case of 10 packages (2 electrodes/pkg.)
2224	EZ Trode - 2" square self-adhering, reusable electrodes with lead wires; case of ten packages (four electrodes/pkg.)
2702	V Trode -2" diameter round electrodes with lead wires, case of ten packages (four electrodes/pkg.)
2703	V Trode -2.75" diameter round electrodes with lead wires, case of 10 packages (four electrodes/pkg.)
2704	V Trode -2" x 4" oval electrodes with lead wires, case of 10 packages (four electrodes/pkg.)
2705	V Trode -2" square electrodes with lead wires, case of 10 packages (four electrodes/pkg.)
73	Mobile cart – Can hold any Sonicator therapeutic ultrasound with the Sys*Stim 228, side by side. Has two additional shelves to hold supplies.
7293	Detachable U.L. listed, hospital-grade line cord