

# seca 874

## Instructions for Use

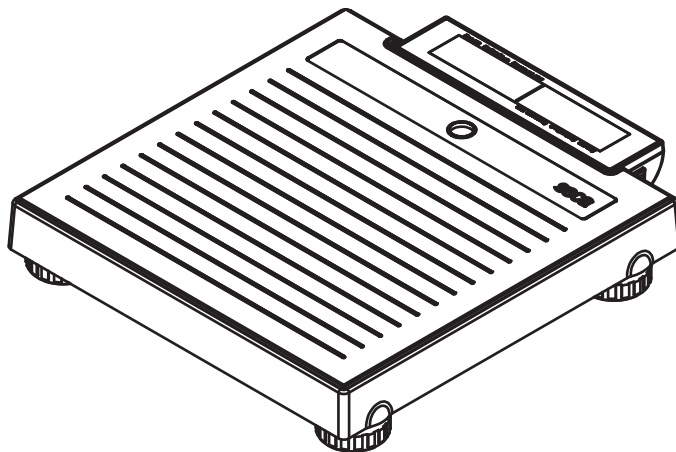

# CONTENTS

|   |           |  |           |
|---|-----------|--|-----------|
| <b>1. Device description</b> .....                      | <b>3</b>  | <b>5. Operation</b> .....                  | <b>12</b> |
| 1.1 Intended use .....                                  | 3         | 5.1 Weighing .....                         | 12        |
| 1.2 Description of function .....                       | 3         | Starting the weighing procedure .....      | 12        |
| 1.3 User qualification .....                            | 3         | Weighing babies/toddlers (2-in-1) .....    | 12        |
| <b>2. Safety precautions</b> .....                      | <b>3</b>  | Switching weight unit .....                | 13        |
| 2.1 Safety precautions in these instructions for use .. | 3         | Switching off the scale .....              | 13        |
| 2.2 Basic safety instructions .....                     | 4         | <b>6. Hygiene treatment</b> .....          | <b>13</b> |
| Handling the device .....                               | 4         | 6.1 Cleaning .....                         | 14        |
| Preventing electric shock .....                         | 5         | 6.2 Disinfecting .....                     | 14        |
| Preventing injuries and infections .....                | 5         | 6.3 Sterilizing .....                      | 14        |
| Preventing device damage .....                          | 6         | <b>7. Function check</b> .....             | <b>14</b> |
| Using the measured results .....                        | 6         | <b>8. What do I do if...?</b> .....        | <b>15</b> |
| Dealing with packaging .....                            | 7         | <b>9. Maintenance</b> .....                | <b>16</b> |
| 2.3 Handling batteries and battery packs .....          | 8         | <b>10. Technical data</b> .....            | <b>16</b> |
| <b>3. Overview</b> .....                                | <b>9</b>  | 10.1 General technical data .....          | 16        |
| 3.1 Controls .....                                      | 9         | 10.2 Weighing data .....                   | 17        |
| 3.2 Symbols in the display .....                        | 9         | <b>11. Optional accessories</b> .....      | <b>17</b> |
| 3.3 Marking on device and on the rating plate .....     | 10        | <b>12. Disposal</b> .....                  | <b>17</b> |
| 3.4 Identification on the packaging .....               | 10        | 12.1 Disposing of the scale .....          | 17        |
| <b>4. Before you really get started ...</b> .....       | <b>11</b> | 12.2 Batteries and battery packs .....     | 17        |
| 4.1 Scope of delivery .....                             | 11        | <b>13. Warranty</b> .....                  | <b>18</b> |
| 4.2 Establishing power supply .....                     | 11        | <b>14. Declaration of conformity</b> ..... | <b>18</b> |
| Inserting battery .....                                 | 11        |  |           |
| Connect the power supply unit (optional) .....          | 11        |  |           |
| 4.3 Setting up and aligning scale .....                 | 12        |  |           |

## 1. DEVICE DESCRIPTION

### 1.1 Intended use

---

The electronic personal scale is mainly used at hospitals, practices and inpatient care facilities in accordance with national regulations.

The scale is for conventional determination of weight and establishment of general state of nutrition; it assists the physician supervising treatment in making a diagnosis or deciding on a course of treatment.

To make an accurate diagnosis, however, other specific examinations have to be ordered by the physician and their results taken into account, in addition to determining a weight value.

### 1.2 Description of function

---

On the **seca 874** electronic personal scale, weight is detected by four load cells.

Weight display can be switched between kilogrammes (kg) and pounds (lbs).

The **2 in 1** function can be used to determine the weight of babies and toddlers. The child is held in an adult's arms during weighing to do so.

Use the scale only for the purpose quoted in the section entitled "Intended use".

### 1.3 User qualification

---

The device may only be operated by healthcare professionals.

## 2. SAFETY PRECAUTIONS

### 2.1 Safety precautions in these instructions for use

---

 **DANGER!**  
Used to identify an extremely hazardous situation. If you fail to take note of this information, serious irreversible or fatal injuries will occur.

 **WARNING!**  
Used to identify an extremely hazardous situation. If you fail to take note of this information, serious irreversible or fatal injuries may result.

 **CAUTION!**  
Used to identify a hazardous situation. If you fail to take note of this information, minor to moderate injuries may result.

**NOTICE!**  
Used to identify possible incorrect usage of the device. If you fail to take note of this information, you may damage the device, or the measured results may be incorrect.

**NOTE**  
Includes additional information about use of the device.

## 2.2 Basic safety instructions

---

### Handling the device

- ▶ Please take note of the information in these instructions for use.
- ▶ Keep the instructions for use in a safe place. The instructions for use are a component of the device and must be available at all times.



#### **DANGER!**

##### **Risk of explosion**

Do not use the device in an environment in which one of the following gases has accumulated:

- ▶ oxygen
- ▶ flammable anesthetics
- ▶ other flammable substances/air mixtures



#### **CAUTION!**

##### **Patient hazard, damage to device**

- ▶ Have servicing carried out regularly as described in the relevant section of this document.
- ▶ Technical modifications may not be made to the device. The device does not contain any parts for servicing by the user. Only have servicing and repairs performed by an authorized seca service partner. You can find service partners in your area at [www.seca.com](http://www.seca.com) or by sending an e-mail to [service@seca.com](mailto:service@seca.com).
- ▶ Only use original seca accessories and spare parts, otherwise seca will not grant any warranty.



#### **CAUTION!**

##### **Patient hazard, malfunction**

- ▶ Keep other electrical medical devices, e.g. high-frequency surgical devices, a minimum distance of approx. 1 meter away to prevent incorrect measurements or wireless transmission interference.
- ▶ Keep HF devices such as cell phones a minimum distance of approx. 1 meter away to prevent incorrect measurements or wireless transmission interference.
- ▶ The actual transmission output of HF equipment may require minimum distances of more than 1 meter. Details can be found at [www.seca.com](http://www.seca.com).

**Preventing electric shock****WARNING!****Electric shock**

- ▶ Set up the device so that the power supply socket is easy to reach and the device can be disconnected from the power supply quickly.
- ▶ Ensure that your local power supply matches the information on the power supply unit.
- ▶ Do not touch the power supply unit with wet hands.
- ▶ Do not use extension cables or power strips.
- ▶ Make sure that cables are not pinched or damaged by sharp edges.
- ▶ Make sure that cables do not come into contact with hot objects.
- ▶ Do not operate the device at an altitude of more than 3000 m above sea level.

**Preventing injuries and infections****WARNING!****Injury from falls**

- ▶ Ensure that the device is positioned firmly and level.
- ▶ Route connecting cables (if present) in such a way that neither user nor patient can trip over them.
- ▶ The device is not designed as a standing aid. Assist people with limited motor skills when they are getting up, e.g. from a wheelchair.
- ▶ Make sure that the patient does not step onto and off the weighing platform right at the edges.
- ▶ Make sure that the patient steps onto and off the weighing platform slowly and safely.

**WARNING!****Danger of slipping**

- ▶ Ensure that the weighing platform is dry before the patient steps onto it.
- ▶ Ensure that the patients feet are dry before he or she steps onto the weighing platform.
- ▶ Make sure that the patient steps onto and off the weighing platform slowly and safely.

**WARNING!****Risk of infection**

- ▶ Hygienically reprocess the scale regularly as described in the respective section in this document.
- ▶ Make sure that the patient has no infectious diseases.
- ▶ Make sure that the patient has no open wounds or infectious skin alterations, which may come into contact with the device.

## Preventing device damage

### NOTICE!

#### Damage to device

- ▶ Ensure that no liquids enter the device. They can damage the electronics.
- ▶ Switch off the device before disconnecting the power supply unit from the mains socket.
- ▶ Disconnect the power supply unit from the mains socket if you intend to not use the device for a longer period of time. Only this way it can be ensured that the device is currentless.
- ▶ Make sure not to drop the device.
- ▶ Do not expose the device to any impacts or vibrations.
- ▶ Perform function controls regularly as described in the relevant section in this document. Do not operate the device if it is damaged or not working properly.
- ▶ Ensure that there is no heat source in the immediate vicinity. Do not expose to direct sunlight. The excessive temperature could damage the electronics.
- ▶ Avoid rapid temperature fluctuations. When the device is transported so that a temperature difference of more than 20 °C occurs, it must stay turned off for at least 2 hours before it can be turned on again. Otherwise, condensation water will form which can damage the electronics.
- ▶ Use only chlorine and alcohol-free disinfectants which are explicitly suitable for acrylic sheet and other sensitive surfaces (active ingredient: quaternary ammonium compounds, for example).
- ▶ Do not use aggressive or abrasive cleaning agents.
- ▶ Do not use organic solvents (e.g. white spirit or petroleum spirit).

## Using the measured results



### WARNING!

#### Patient hazard

This device is **no** diagnostic device. It simply assists the treating physician in establishing a diagnosis.

- ▶ In order to make a precise diagnosis and initiate therapeutic measures, besides determination of the weight, further targeted examinations must be set up by the physician, and their results must be considered.
- ▶ The responsibility for diagnosis and treatment lies with the treating physician.



### CAUTION!

#### Patient hazard

In order to avoid misinterpretations, test results for medical use must be displayed and used in SI units (weight: kilogrammes, length: metres) only. Some devices offer the ability to display test results in other units. This is only an additional function.

- ▶ Use the results exclusively in SI units.
- ▶ The use of measurement results in non-SI units is the sole responsibility of the user.

**NOTICE!**

**Inconsistent measuring results**

- ▶ Before you electronically save measurement values determined using this device and use them further (e.g. in seca PC software or in a hospital information system), make sure that the measurement values are plausible.
- ▶ If measurement values are transmitted to seca PC software or a hospital information system, make sure prior to further use that the measurement values are plausible and are assigned to the correct patient.

**Dealing with packaging**



**WARNING!**

**Risk of suffocation**

Packaging material made of plastic foil (bags) is a choking hazard.

- ▶ Keep packaging material out of reach of children.
- ▶ In the event that the original packing material may not be available anymore, only use plastic bags with security holes in order to reduce the risk of suffocation. Use recyclable materials if possible.

**NOTE**

Keep the original packing material for future use (e.g. returning for maintenance service).

## 2.3 Handling batteries and battery packs

---

seca devices are supplied with a rechargeable battery pack or with batteries depending on model. Heed the following safety instructions.



### **WARNING!**

#### **Personal injury due to improper handling**

Batteries and rechargeable batteries contain harmful substances which may explode if not handled properly.

- ▶ Do not try to recharge batteries.
- ▶ Do not expose (rechargeable) batteries to heat.
- ▶ Do not burn (rechargeable) batteries.
- ▶ If acid is leaking out, avoid contact with the skin, eyes and mucous membranes. Rinse affected areas with plenty of clean water and seek medical help at once.

### **NOTICE!**

#### **Damage to device and malfunctions with improper handling**

- ▶ Only use the type of (rechargeable) battery specified in this document.
- ▶ When replacing (rechargeable) batteries, always replace a complete set at a time.
- ▶ Do not short-circuit (rechargeable) batteries.
- ▶ If you do not use the device for a long period of time, remove the batteries (incl. rechargeable batteries). This prevents acid from leaking into the device.
- ▶ If acid leaked into the device, discontinue use. Have the device checked by an authorised seca service partner and repaired if necessary.



### 3. OVERVIEW

#### 3.1 Controls

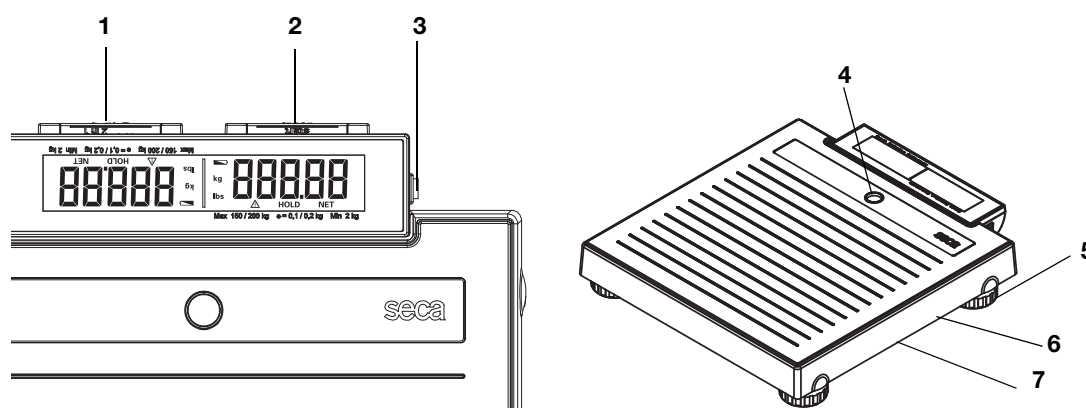





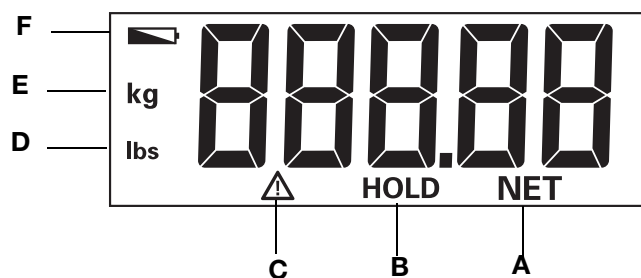



| No. | Control                            | Function   |
|-----|------------------------------------|--|
| 1   | <b>2 in 1</b> key<br>kg/lbs switch | <ul style="list-style-type: none"> <li>Starting the <b>2 in 1</b> function to weigh babies and toddlers</li> <li>Switching between kg and lbs</li> </ul> |
| 2   | <b>start</b> key                   | Starting the weighing function   |
| 3   | On/off switch                      | Switching the scale on and off   |
| 4   | Spirit level                       | Shows whether the device is horizontal   |
| 5   | Foot screw                         | 4 pcs, for precise alignment   |
| 6   | Power supply connection            | For connecting a power supply unit available as an option  |
| 7   | Battery compartment                | Takes 6 AA-type batteries, 1.5 V   |

#### 3.2 Symbols in the display



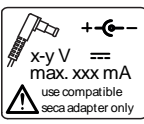





|   | Symbol          | Meaning   |
|---|-----------------|---|
| A | <b>NET</b>      | Tare function active                              |
| B | <b>HOLD</b>     | Hold function active                              |
| C | ⚠               | Non-verifiable function active                    |
| D | <b>lb / lbs</b> | Weight value in pounds (non-verified models only) |
| E | <b>kg / g</b>   | Weight value in kilograms/grams                   |
| F | 🔋               | Batteries are low                                 |

### 3.3 Marking on device and on the rating plate

| Text/symbol   | Meaning   |
|---|---|
| <b>Mod</b>  | Model number  |
| <b>S/N</b>  | Serial number, consecutive  |
| <b>ProdID</b>   | Product identification number, consecutive  |
|  | Follow instructions for use   |
|  | Electrical medical device, type B   |
|  | Insulated device, protection class II   |
| d   | Value in mass units (unverified model)<br>Gives the difference between two consecutive display values   |
|  | Device complies with EC directives<br>• <b>0123</b> : appointed office for medical devices  |
|  | Rating plate on the power supply connection socket<br>• <b>xx V</b> : required supply voltage<br>• <b>max xx A</b> : maximum current consumption<br>•  : note polarity of device plug.<br>•  : operate device with direct current |
|  | Do not dispose of device with household waste   |

### 3.4 Identification on the packaging

|   |  |
|---|--|
|  | Protect from moisture  |
|  | Arrows indicate top of product.<br>Transport and store in an upright position. |
|  | Fragile<br>Do not throw or drop.   |
|  | Permitted min. and max. temperature for transport and storage                  |
|  | Permitted min. and max. moisture for transport and storage                     |
|  | Open packaging here  |
|  | Packaging material can be disposed of through recycling programs               |

## 4. BEFORE YOU REALLY GET STARTED ...

### 4.1 Scope of delivery

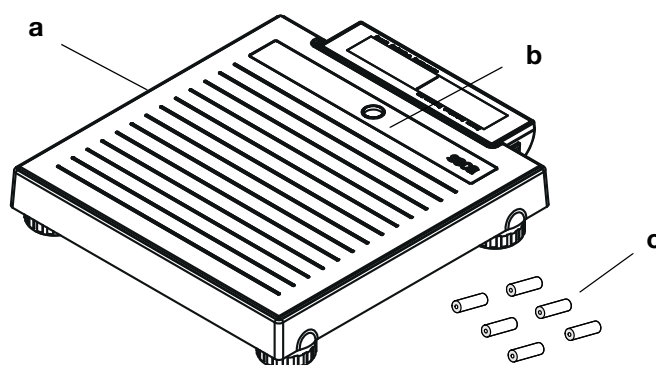

| No. | Component                     | Pcs. |
|-----|-------------------------------|------|
| a   | Personal scale                | 1    |
| b   | Interchangeable design panel  | 1    |
| c   | Battery                       | 6    |
| -   | "Changing design panel" flyer | 1    |
| -   | Operating instructions        | 1    |

### 4.2 Establishing power supply

#### Inserting battery

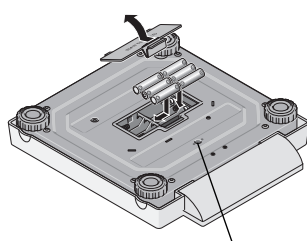

Connection for power supply unit

You need 6 AA-type batteries, 1.5 V (scope of delivery).

1. Press on the latch of the battery compartment.
2. Fold down the cover of the battery compartment.
3. Take out the battery holder.
4. Put the batteries in the holder.

#### NOTE:

Ensure the correct polarity of the batteries (markings in the battery holder). If the display **bAtE** appears, you have inserted one of the batteries the wrong way round or the batteries have discharged.

5. Place the holder containing the batteries in the battery compartment.
6. Close the battery compartment.

#### Connect the power supply unit (optional)

The scale can be operated with a power supply unit (accessory).



#### WARNING!

**Using the wrong power supply units may cause bodily injury or damage to the device**

Conventional power supply units may deliver a higher voltage than is indicated on them. The scale may overheat, catch fire, melt or short-circuit.

- Use only original seca plug-in power supply units with controlled 12 V output voltage.

1. Insert the plug required for your power supply into the power supply unit.
2. Insert the connector of the power supply unit into the connecting socket of the scale.
3. Plug the power supply unit into a power supply socket.

## 4.3 Setting up and aligning scale

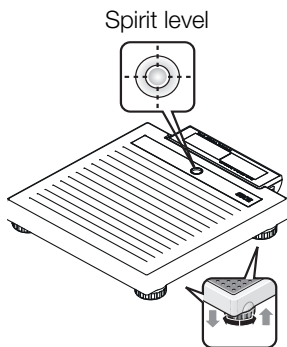

1. Place the scale on a firm surface.
2. Align the scale by turning the foot screws.  
The air bubble in the spirit level must be located in the exact center of the circle.
3. Ensure that only the feet of the scale are in contact with the ground. The scale may not be in contact anywhere else.

**NOTE:**

The alignment of the base of the scale must be checked every time the scale is moved and corrected if required.

## 5. OPERATION

### 5.1 Weighing

#### Starting the weighing procedure

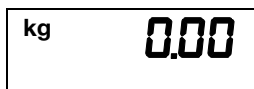

1. Ensure that there is no load on the scale.
2. Press the **start** key.  
**SECA** appears in the display, then all the elements of the display are shown briefly.  
The scale is operational when **0.00** appears in the display.  
If the scale is operated with a power supply unit, the  $\nabla$  symbol appears in the display.
3. Switch the weight display if necessary (see "Switching weight unit" on page 13).
4. Stand on the scale and keep still.

**NOTE:**

The HOLD function is activated automatically at weights of over 1.5 kg or 3.3 lbs. The display flashes until a stable weight has been measured. The display then freezes until the next weighing operation.  
 $\Delta$  **HOLD** appears in the display.

5. Read off the measured result.

#### Weighing babies/toddlers (2-in-1)

The **2 in 1** function can be used to determine the weight of babies and toddlers. The child is held in an adult's arms during weighing to do so. Proceed as outlined below.

1. Ensure that there is no load on the scale.
2. Ask the adult to stand on the scale.
3. Read off the measured result.
4. Keep the **2 in 1** key depressed until the message NET appears in the display.

The weight is saved.

**0.00** appears in the display.

**ATTENTION!**

**Incorrect measurement as a result of changing starting weight**

If weighing of the child commences with a different starting weight, it will not be possible to determine the child's weight correctly.

- ▶ Ensure that the child is always weighed with the adult with whom the starting weight was determined.
- ▶ Ensure that the adult's weight does not change - as a result of their taking off a piece of clothing, for example.

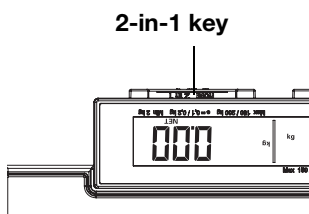

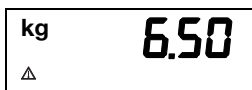

5. Ask the adult to get onto the scale holding the child.  
The child's weight is displayed.  
The  $\triangle$  symbol and the messages "HOLD" and "NET" are displayed.
6. Ask the adult to get off the scale with the child.
7. In order to deactivate the **2 in 1** function, press the **2 in 1** key until the  $\triangle$  symbol and the "HOLD" and "NET" messages are no longer displayed, or switch off the scale.

### Switching weight unit

The weight display can be switched between kilograms (kg) and pounds (lbs).

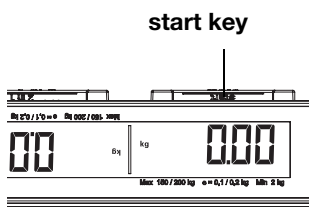

1. Switch on the scale using the **start** key.  
The current weight unit (in this case kg) will be displayed

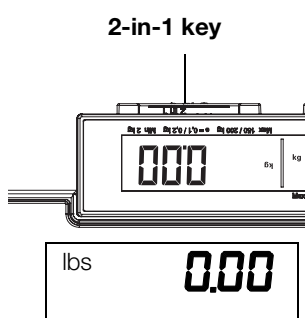

2. Keep the **2 in 1** key depressed for approx. 3 seconds.

The unit is switched (in this case lbs).

3. To switch the unit back again, keep the **2 in 1** key depressed for approx. 3 seconds again.

### Switching off the scale

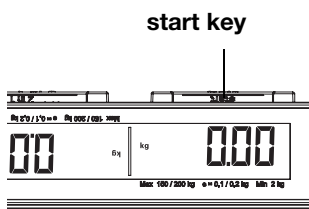

- ▶ Press the **start** key.

**NOTE:**

The scale switches off automatically after a short time if there is no load on it.

## 6. HYGIENE TREATMENT



**WARNING!**  
**Electric shock**

The device is not de-energized when the on/off key is pressed and the display goes out. Use of fluids on the device may cause electric shock.

- ▶ Ensure that the device is switched off before performing any hygiene treatment.
- ▶ Disconnect the power supply connector before performing any hygiene treatment.
- ▶ Ensure that no fluids penetrate the device.



### CAUTION!

#### Damage to device

Inappropriate detergents and disinfectants may damage the sensitive surfaces of the device.

- ▶ Use only disinfectants free of chlorine and alcohol which are explicitly suitable for acrylic sheet and other sensitive surfaces (active ingredient: quaternary ammonium compounds, for example).
- ▶ Do not use white spirit or petroleum spirit.
- ▶ Only use disinfectants suitable for sensitive surfaces. Suitable disinfectants are available from specialist dealers.

## 6.1 Cleaning

---

- ▶ Use a soft cloth dampened with mild soapsuds to clean the surfaces of the device.

## 6.2 Disinfecting

---

1. Check that your disinfectant is suitable for sensitive surfaces and acrylic sheet.
2. Follow the instructions on the disinfectant.
3. Disinfect the device by moistening a soft cloth in disinfectant and wiping the device over with it.

| Interval  | Component         |
|---|-------------------|
| Prior to every measurement with direct skin contact | Weighing platform |
| After every measurement with direct skin contact    | Weighing platform |
| If required   | Display           |

## 6.3 Sterilizing

---

This device may not be sterilised.

## 7. FUNCTION CHECK

- ▶ Perform a function check prior to each use.

A complete function check includes:

- visual inspection for mechanical damage
- checking the alignment of the device
- visual and function check of the display elements
- function check of all the controls shown in the section entitled "Overview"
- function check of optional accessories

If you notice any faults or deviations during the function check, first try to resolve the error with the aid of the section entitled "What do I do if ..." in this document.

**CAUTION!****Personal injury**

If you notice any faults or deviations during the function check which cannot be resolved with the aid of the section entitled "What do I do if ..." in this document, you may not use the device.

- ▶ Have the device repaired by seca service or by an authorized service partner.
- ▶ Follow the section entitled "Servicing" in this document.

## 8. WHAT DO I DO IF...?

| Problem   | Cause/solution   |
|---|--|
| ... no weight is displayed when there is a load on the scale?   | The scale has no power supply.<br>- Check whether the scale is switched on<br>- Check whether batteries are inserted   |
| ... the scale switches on, during transport for example?  | The <b>start</b> key has been pressed. As the scale has a very low energy consumption, this will have very little effect on battery life.<br>- Set the On/off switch to "OFF" for relatively long transport distances  |
| ... a weight value appears in the display of the scale following transport or a change of batteries, even without a load on it? | The scale has determined an incorrect zero point.<br>- Start the scale again. The scale will then work normally again  |
| ... 0.00 does not appear before weighing?   | A load was already on the scale before it was switched on.<br>- Remove the load from the scale<br>- Switch the scale off and back on again   |
| ... - - - - appears before weighing instead of 0.00?  | A load was already on the scale before it was switched on.<br>- Remove the load from the scale<br>- Switch the scale off and back on again   |
| ... one segment is illuminated either continuously or not at all?   | The corresponding point has a fault.<br>- Inform the maintenance service   |
| ... the display  appears?                    | Battery voltage is dropping.<br>- Insert new batteries as soon as possible   |
| ... the display <i>bAtt</i> appears?  | The batteries have discharged.<br>- Insert new batteries   |
| ... the display <i>bAtt</i> appears with the seca solar panel (optional) connected?   | Sunlight is inadequate<br>- Align solar panel better in relation to the sun<br>- Disconnect the solar panel connector, the scale will automatically switch to battery operation.   |
| ... the display <i>StOP</i> appears?  | Maximum load has been exceeded.<br>- Remove the load from the scale  |
| ... the display <i>Er</i> and a number appear?  | The scale has been incorrectly loaded.<br>- Re-start the scale after it has switched off automatically. The scale will then work normally again.<br>- If this is not the case, interrupt the power supply by switching the scale off briefly at the On/off switch. If this measure is also unsuccessful, inform the maintenance service. |

## 9. MAINTENANCE

On leaving the factory, your seca scale has an accuracy of  $\pm 0.15\%$  /  $\pm 50\text{ g}$  /  $\pm 0.22\text{ lbs}$ . To preserve this level of accuracy, the product must be set up with care and maintained on a regular basis. Depending on how frequently the scale is used, we recommend servicing at intervals of 3 to 5 years.



### ATTENTION!

#### Incorrect measurements as a result of poor servicing

- ▶ Please only have servicing and repairs performed by an authorized service partner.
- ▶ You can find service partners in your area at [www.seca.com](http://www.seca.com) or by sending an e-mail to [service@seca.com](mailto:service@seca.com).

## 10. TECHNICAL DATA

### 10.1 General technical data

| General technical data  |   |
|---|---|
| Dimensions <ul style="list-style-type: none"> <li>• Depth</li> <li>• Width</li> <li>• Height</li> </ul>   | 360 mm<br>321 mm<br>60 mm   |
| Net weight  | approx. 4.0 kg (8.8 lbs)  |
| Temperature range <ul style="list-style-type: none"> <li>• Operation</li> <li>• Storage</li> <li>• Transport</li> </ul>   | +10 °C to +40 °C (50 °F to 104 °F)<br>-10 °C to +65 °C (14 °F to 149 °F)<br>-10 °C to +65 °C (14 °F to 149 °F)  |
| Air pressure <ul style="list-style-type: none"> <li>• Operation</li> <li>• Storage</li> <li>• Transport</li> </ul>  | 700 - 1060 hPa<br>700 - 1060 hPa<br>700 - 1060 hPa  |
| Humidity <ul style="list-style-type: none"> <li>• Operation</li> <li>• Storage</li> <li>• Transport</li> </ul>  | 30 % - 80 %, no condensation<br>0 % - 95 %, no condensation<br>0 % - 95 %, no condensation  |
| Height of digits  | 20 mm   |
| Power supply <ul style="list-style-type: none"> <li>• Power supply unit               <ul style="list-style-type: none"> <li>- Supply voltage</li> <li>- Maximum current consumption</li> </ul> </li> <li>• Batteries               <ul style="list-style-type: none"> <li>- Supply voltage</li> <li>- Maximum current consumption</li> </ul> </li> </ul> | 12 V<br>typically 50 mA<br>9 V<br>typically 50 mA   |
| Medical device in accordance with Directive 93/42/EEC   | Class I with measuring function   |
| EN 60 601-1: <ul style="list-style-type: none"> <li>• insulated device, protection class II:</li> <li>• electrical medical device, type B:</li> </ul>   | <div style="text-align: center;"> <br/>  </div> |
| Type of protection  | IP20  |
| Operating mode  | Continuous duty   |



## 10.2 Weighing data

| Weighing technology data for seca874 |                                   |
|--------------------------------------|-----------------------------------|
| Maximum load                         | 200 kg (440 lbs)                  |
| Accuracy                             | ± 100 g (0.22 lbs)<br>± 0.15 %    |
| Graduations                          | 50 g (0.1 lbs)<br>100 g (0.2 lbs) |

## 11. OPTIONAL ACCESSORIES

| Accessory  | Article number   |
|--|------------------|
| Carry case <b>seca 421</b>   | 421-00-00-009    |
| Carry case <b>seca 415</b>   | 415-00-00-009    |
| Individualized design panel  | 01-13-05-499-009 |
| Power supply:  |                  |
| • Plug-in power supply, Euro: 230 V~ / 50 Hz / 12 V= / 150 mA            | 68-32-10-252     |
| • Switched-mode power supply unit: 100-240 V~ / 50-60 Hz / 12 V= / 0.5 A | 68-32-10-266     |

## 12. DISPOSAL

### 12.1 Disposing of the scale



Do not dispose of the device with household waste. The device must be disposed of properly as electronic waste. Comply with the national provisions applicable in your country. For further information contact our service department at:

[service@seca.com](mailto:service@seca.com)

### 12.2 Batteries and battery packs



Spent (rechargeable) batteries should not be discarded with household waste, regardless of whether they contain harmful substances or not. As a consumer you are obliged by law to dispose of (rechargeable) batteries via the collection points set up by the municipal authorities or the retail sector. Only discard (rechargeable) batteries when fully discharged.

## **13. WARRANTY**

We offer a two-year warranty from the date of delivery for defects attributable to faulty material or poor workmanship. This excludes all moveable parts such as (rechargeable) batteries, cables, power supply units, etc. Defects which are covered by the warranty shall be rectified free of charge for customers on production of the sales receipt. No further claims can be accepted. The costs of shipment in both directions shall be borne by the customer where the device is not located at the customer's premises. In the event of any damage during shipment warranty claims can only be asserted where the complete original packaging was used for shipment and the scales were secured inside in the same manner as in the original packaging. You should therefore keep all packaging.

The warranty shall become null and void where the device is opened by persons not expressly authorised to do so by seca.

We ask customers based abroad to contact their local sales agent directly in the case of warranty claims.

## **14. DECLARATION OF CONFORMITY**

seca gmbh & co. kg hereby declares that the product meets the terms of the applicable European directives. The unabridged declaration of conformity can be found at: [www.seca.com](http://www.seca.com).

