

# EasyStand<sup>®</sup> Bantam Extra Small & Small

Please ensure the Owner's Manual stays with the unit at all times.



Owner's Manual

## SYMBOL LEGEND



**CAUTION/ATTENTION**



**ENVIRONMENTAL  
CONDITIONS**



**TYPE BF APPLIED PART**



**DATE OF MANUFACTURE**



**PINCHPOINT**



**SEE INSTRUCTIONS FOR USE**

**SN**

**SERIAL NUMBER**



**MANUFACTURER**



Please be environmentally responsible and recycle this product through your recycling facility at its end of life.

Afin de préserver l'environnement, veuillez confier ce produit à votre centre de recyclage à la fin de sa durée de vie.

Nachdem dieses Produkt ausgedient hat, entsorgen Sie es bitte auf umweltfreundliche Weise, indem Sie es zu der entsprechenden Recyclingstelle bringen.

Wees a.u.b. milieubewust en recycleer dit product via uw recycleerder na het verstrijken van de levensduur.

Sea responsable con respecto al medio ambiente y recicle este producto al finalizar su vida útil en el lugar de reciclaje correspondiente.

Siate responsabili verso l'ambiente e riciclate questo prodotto, al termine della sua vita d'uso, presso la vostra sede di riciclaggio.

Kierrätä tämä tuote sen käyttöiän lopussa ympäristövastuullisella tavalla paikallisella kierrätyslaitoksella.

Var miljömedveten och återvinn denna produkt efter dess användning.

Vi ber deg ta hensyn til miljøet og resyklere dette produktet ved hjelp av de rette resyklingsfasilitetene når produktet ikke lenger kan brukes.

Vis venligst hensyn til miljøet ved at levere produktet til det nærmeste genbrugsanlæg, når det ikke længere fungerer.

Por favor, assumo responsabilidade ambiental, reciclando este produto em suas instalações de reciclagem no final de sua vida útil.

# Table of Contents

<b>Introduction</b> . . . . .	<b>1</b>
<b>Safety Precautions</b> . . . . .	<b>2</b>
<b>Assembly</b> . . . . .	<b>3</b>
<b>Mobile Assembly</b> . . . . .	<b>12</b>
<b>Adjustments &amp; Usage</b> . . . . .	<b>14</b>
<b>Pow'r Up Lift Option Usage</b> . . . . .	<b>23</b>
<b>Parts Detail</b> . . . . .	<b>28</b>
<b>Standing</b> . . . . .	<b>29</b>
<b>Maintenance</b> . . . . .	<b>30</b>
<b>TroubleShooting</b> . . . . .	<b>31</b>
<b>Limited Warranty</b> . . . . .	<b>32</b>

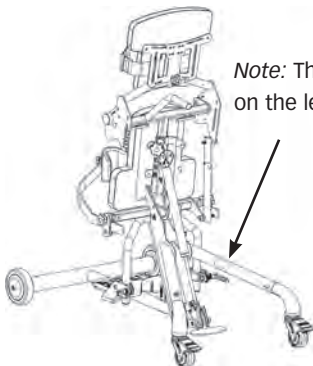

*Note:* The serial number is located on the leg bracket.

Date Purchased \_\_\_\_\_ Serial # \_\_\_\_\_

# Introduction

Congratulations on your purchase of an EasyStand standing frame! We at Altimate Medical have designed the EasyStand with your comfort and happiness in mind.

## EasyStand Description

The EasyStand line of products is intended for individuals who are able to transfer independently or with assistance from a caregiver and/or lifting device. It is a useful tool for rehabilitation, home, school, and work use. EasyStand standing frames support the user from sitting to the standing position. Various options such as support, choice of manual or Pow'r Up Lift may be added to facilitate individual needs.

## Intended Use

The EasyStand Bantam line of products is intended to assist individuals who have difficulty rising from a seated position to a standing position.

## Indications for Use

The Bantam Extra Small is indicated for most individuals weighing up to 50 lbs. and within the height range of 28"-40". The Bantam Small is indicated for most individuals weighing up to 100 lbs. and within the height range of 36"-54".

**This manual is an integral part of your standing system and should be read completely and thoroughly by anyone that will be operating the unit.** This will ensure the EasyStand Bantam is assembled properly and used in the most beneficial manner.

It is necessary to inspect your EasyStand Bantam at least weekly to ensure it is in safe operating condition. EasyStand adjustments that are listed in the product owner's manual can be made by the operator by following the instructions for use. After an adjustment is made, inspect the EasyStand to ensure all hardware and adjustable components are properly secured per the instructions for use. Replacement of worn parts, major adjustments, or any other important corrections should be handled by an authorized supplier or service center. Only Altimate Medical, Inc., approved replacement parts should be used to ensure safety and performance.

**The EasyStand Bantam shall be prescribed by a qualified physician or occupational/physical therapist. Do not use the EasyStand Bantam without consulting your physician and receiving protocol for a standing program. Failure to consult a qualified physician prior to using the EasyStand Bantam could lead to medical problems. The EasyStand Bantam must be used with a qualified adult attendant present. Should any problems arise that you cannot solve by reading this manual, please contact your local supplier or call Altimate Medical, Inc., at 800-342-8968 or 507-697-6393. **

## Join the Standing Community!

Our goal is simple - to empower people with disabilities to stand up for their health. Connect, share, and learn from other people with disabilities, special needs parents, clinical professionals, and the experts in standing on our social networking communities. By keeping your standing program "top of mind" you will have the greatest chance of maintaining a standing routine that maximizes all the benefits of standing!

Read, share, and comment on the EasyStand Blog at [blog.easystand.com](http://blog.easystand.com)

Find EasyStand on these social networking sites:



# Safety Precautions

- Please read and understand all safety precautions and user instructions prior to use. Call Altimate Medical at 800-342-8968 or 507-697-6393 with any questions or for additional information.
- If a user does not meet the specifications below and has not been properly fitted by a qualified therapist or physician, Altimate Medical, Inc., does not recommend using the EasyStand Bantam.

**Bantam (Extra Small)** - is designed to accommodate most individuals from 28"-40" (71-102cm) and up to 50 lbs. (23kg)

**Bantam (Small)** - is designed to accommodate most individuals from 36"-54" (91-137cm) and up to 100 lbs. (45kg)

**Overall dimensions of Bantam Extra Small/Small (approximate):**

- The Bantam Extra Small maximum mass plus its safe working load is approximately 160 lbs. (73 kg)
  - The Bantam Small maximum mass plus its safe working load is approximately 210 lbs. (95 kg)
    - The maximum width is 30" (762 mm)
  - The maximum height while unit is in standing position is 65" (1651 mm)
  - The maximum length while unit is in supine position is 64" (1626 mm)
- For more detailed specifications visit our website [www.easystand.com](http://www.easystand.com)*

- The EasyStand Bantam should not be used without first consulting a qualified physician. Failure to consult a qualified physician prior to using the EasyStand Bantam could lead to severe medical problems. We recommend a good standing program be established and supervised by a qualified, registered physical therapist.
- The EasyStand Bantam should always be used with a qualified adult attendant present. Never leave a child unattended in the Bantam.
- Do not make adjustments to the Bantam while in the standing position. **Exception: If the supine option was ordered, refer to pages 17-19. Changes in position must be performed or supervised by a qualified caregiver or medical professional.**
- It is necessary to inspect the EasyStand Bantam at least weekly to ensure it is in safe operating condition. Pay particular attention for loose hardware. If the EasyStand is equipped with the optional Pow'r up lift, please inspect the electrical cables for any wear and ensure they are attached properly. Replacement of worn parts, major adjustments, or other important corrections should be handled by an authorized dealer or service center. Only Altimate Medical, Inc., approved replacement parts should be used to ensure safety and performance.
- If the EasyStand is being used in the home environment, please inspect the unit prior to each use to ensure there is no damage or unexpected wear to the EasyStand that may have been caused unintentionally by pets, pests or children.
- Never reposition the foot plates while the user is in the standing position. Consult with a therapist or physician for proper foot placement and angle.
- Never elevate the legs or adjust the backrest to anterior tilt using the following arm adjustment. Only the supine option may be used to elevate the legrest with simultaneous recline of the backrest.
- Ensure the necessary support and alignment options are in position prior to bringing the child into the standing position.
- If the unit was exposed to temperatures of less than 50°F (23.5°C), the unit must warm to room temperature before use.
- **Operating Conditions:** Temperature: 41°F (5°C) -95°F (35°C), Relative humidity: 20% - 90% at 86°F (30°C), Atmospheric Pressure: 700 to 1060hPa.
- **Storage/Transport Conditions:** Temperature: 14°F (-10°C) -122°F (50°C), Relative humidity: 20% - 90% at 86°F (30°C), Atmospheric Pressure: 700 to 1060hPa.
- The EasyStand can be used at a maximum altitude of 10,000 feet (3,050 meters).
- The expected service life of an EasyStand is considered 5 years under normal use conditions. Note: This may vary based on frequency of use.
- If you must transport the EasyStand in a vehicle, secure the unit so it does not move around. After transport inspect the EasyStand to ensure hardware is properly tightened and all options are secured.
- Standing equipment is designed for indoor use on level surfaces only. Keep casters locked while in use.
- Transporting the unit with a user in the standing position is not recommended.
- Extreme movements laterally or front to back may cause the unit to tip.
- It is recommended the equipment be stored at normal room temperature and humidity levels.
- Altimate Medical products are specifically designed to be used with Altimate Medical accessories and options. Unless otherwise noted, accessories and options from other manufacturers have not been tested by Altimate Medical and are not recommended for use with Altimate Medical products.
- Product Modifications made without express written consent (including, but not limited to, modification through the use of unauthorized parts or attachments) are not recommended and will void the product warranty.
- The EasyStand Bantam Electric Lift meets the requirements of IEC 60601-1 and 60601-1-2.\*
- The wheel lock on the mobile option is to keep the unit in place while transferring or standing stationary and it is **not** intended to be used as a dynamic brake to stop a rolling mobile unit.

 **Caution:** The EasyStand is constructed of materials that do not support combustion under normal conditions. For the safety of the patient and attending personnel, do not allow clutter or debris to be stored or accumulate on or around the equipment.

 **Caution:** This equipment is designed to accommodate a range of users; therefore the unit has various adjustment slots and holes. Avoid placing fingers or other body parts in any of these areas.

 **Caution:** While in use this equipment has various moving parts, familiarize yourself with the unit and avoid placing hands or fingers near any of these areas.

 **Caution:** Do not use the EasyStand Bantam Mobile option on an incline, it is intended for level surfaces only. Doing so may cause the unit to tip.

 **Caution:** Advise bystanders to keep clear of the unit while in use.

\* Bantam Pow'r Up Lift Option Only

# Assembly

1. Remove all parts from the box. Remove the two bolts and two covered nuts from front frame.



2. Flip up the rear frame to allow easier access to the post. Attach the front and rear frames to one another.



3. Place the two covered nuts into the bottom of the frame and flush with the tube. You may have to tap them in with a rubber hammer to make them flush.



4. Place the two bolts into the top of the frame and screw into the covered nut, making sure they are flush. Tighten securely.



5A. Place the unit back in the normal position. If you ordered the optional adjustable removable pump handle, remove knob, bolt and spacer from center of handle. Insert spacer as shown.

5B. Place bolt into the spacer as shown.



6. Place knob onto bolt and tighten securely.



7. Remove pin from the pump, place pump handle onto pump shaft as shown and place pin through holes.



8. Place top of handle on to the handle, insert 2 bolts and tighten securely.



9. Use the optional pump handle or step on the gas spring assist pedal to raise the seat about 3/4 the way up as shown. Line up the following arm with the back angle tube.





**10.** Depress the spring button to allow the following arm to slide into place. Match the following arm position color with the corresponding seat depth color. Tighten the knob securely (for information on seat adjustments see pg. 15).



**11.** Loosen the ratchet handles on the foot plates and swivel into place (for information on foot plate adjustments see pg. 14).



**12A.** Insert each knee bracket into the tubes onto the unit, with the clamp down.

**12B.** Depress the spring button to allow the bracket to slide into place, advance until the spring button locks into place.

For the Swing-Away Knee Pads, insert bracket into place and tighten knobs securely.



**13.** Insert each knee pad bracket into the slots on the knee bracket. Tighten knobs securely.



**14.** Remove knob from the knee pad, leaving the plastic and rubber washer in place on the knee pad, place the knee pad and washers onto the knee pad bracket. Place knob onto bolt as shown. Repeat steps for the opposite side (for information on knee pad adjustments see pg. 14).



**15.** If you ordered the Supine option, remove the controller from the packaging. Remove the two bolts on the bottom of the controller, leaving nuts in place.



16. Place controller onto the bracket on the side of the unit. The bracket will slide into the slot on the bottom of the controller.



17. Making sure the nuts are in the back on the controller, line up holes and insert both bolts. Tighten securely.



18. If you ordered the 11"x19" Black molded tray, place tray on the floor upside down as shown. The longer tray arm will go on the right side, the short arm on the left side.

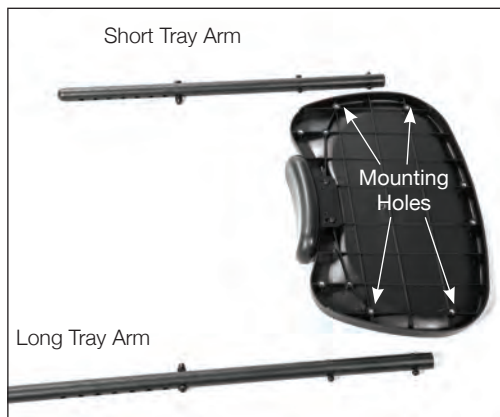

**19A.** Remove the four nuts from the mounting bolts on the arms and discard, do not remove the acorn nut and bolt.



**19B.** With the acorn nut facing up, place the longer arm on the right side of the tray, line up the two mounting holes. Insert bolt, and tighten snug.



**20A.** Place the second bolt into the hole.



**20B.** Using an allen wrench tighten both bolts securely.



With the acorn nut facing up, place the shorter arm on the left side of the tray and repeat steps 18-19.

**21A.** For the tray, remove the nut from the bolt on the tray arm and discard the nut. Make sure all other hardware stays on the bolt.

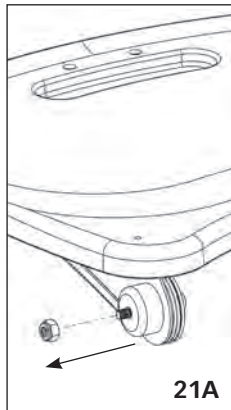

**21B.** Place the ratchet handle onto the bolt and tighten securely. Repeat steps for the other side.

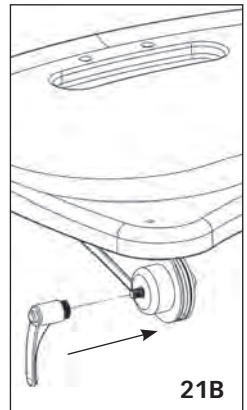

**22.** If you ordered the optional Shadow Tray, loosen the ratchet handles on the side of the tray, flip the arms up so they are lined up with the tray as shown and tighten the ratchet handles. Insert the two tray arms into the tray bracket on the bottom of the tray. One of the arms is longer than the other for easier installation (for information on Shadow Tray adjustments see pg. 20-21). The bolts on the arms are used as a stop for future reference. Place the quick release pins into the holes of the tray to secure into place.



**23.** For the Swing-Away Shadow Tray, the knobs are located in the bag your manual came in. Place knobs onto unit as shown, insert tray bracket and tighten securely.

**⚠ Caution:** After placing the tray into position, ensure the ratchet handles on the side of the tray are tightened securely.



**24A.** If not already on the unit, remove the knob from the center post and place the back onto the unit as shown.

**24B.** Place the back in the desired position. Insert knob and tighten securely.

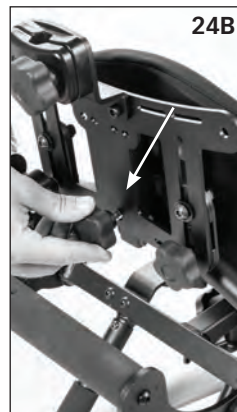

**25A.** If the optional dual lift control was ordered, insert bolt into push handle as shown and line up dual controller. Screw the bolt into the dual controller, tighten securely.



**25B.** If you ordered the optional headrest, insert the head support onto the unit and tighten securely.



**26A.** Remove pull pin from the Supine Assist Handle. Place onto bracket as shown.



**26B.** Line up holes and insert pull pin.



**27.** If you ordered the optional Elbow Pad Cut outs, remove Chest Pad from tray. Disregard bolts, replace bolts with bolts in the bag with the Elbow Pad Cutout. Place Elbow Pad Cutout onto the tray. Line up Chest Pad bracket with holes, insert bolts into Tray and Elbow Pad Cutout. Tighten securely.

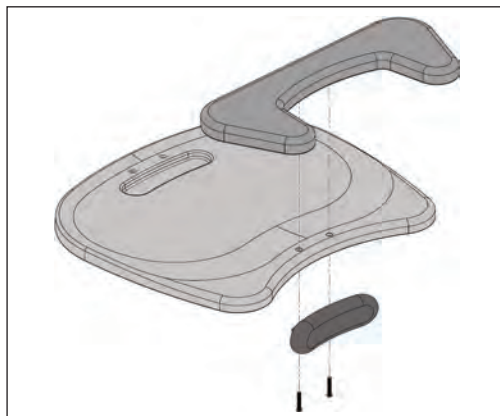

# Mobile Option Assembly

*Note: If this is an option added after the initial purchase, you must remove the existing front assembly before proceeding.*

**28.** The Mobile option consists of two drive wheel assemblies, a "T" style front weldment, barrel nuts and bolts. You will need a 5mm allen wrench and a rubber hammer for assembly.



**29.** Set the Bantam on its back and attach the "T" weldment to the frame. Note that the front curves upward.



**30.** Line up holes and place the covered nuts on the bottom of the frame. You may have to tap them with a rubber hammer to make them flush. Tighten bolts securely.



**31.** Attach the interchangeable right and left drive wheel assemblies to the front frame.



**32.** Line up the holes and tap in the covered nuts and tighten bolts securely. Making sure the covered nuts are flush with the base. Position the Bantam upright and re-tighten the frame bolts.



### **Mobile Adjustment & Usage**

**33.** To lock or unlock the drive wheels, turn the drive wheel lock one quarter turn.

Use the push rim adjustment to position the push rims forward or aft, for transferring or self-propulsion. Tighten to lock in position.

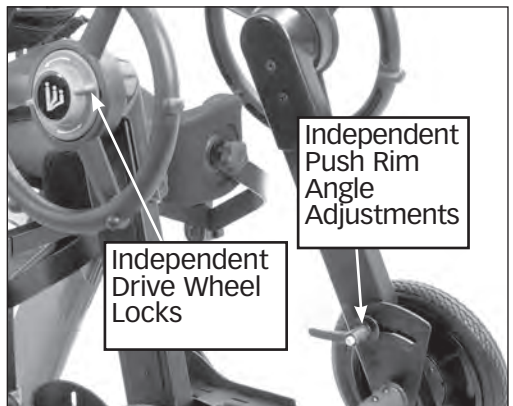



# Adjustments & Usage

## Gas Cylinder

Place foot on the pedal and lift using the assist handle behind the seat to help raise the unit to the standing position. This may also be necessary when lowering the user to the seated position.

## ⚠️ Foot plates

**Caution:** Never reposition the foot plates with the child in the standing position.

**Caution:** Avoid placing fingers in the adjustment slot.

**FIG. A-Height**-The standard foot plates have height adjustment only. Loosen the clamp connecting the foot bracket to the seat post to adjust foot plate height.

The Multi-Adjustable Foot plates have a wide variety of adjustments:

**FIG. B-Plantar/Dorsi**-Loosen clamps to tilt foot plates.

**FIG. C-Adduction**-Loosen clamps to slide foot plates together.

**FIG. D-Forward/Aft**-Loosen knobs underneath foot plates, slide foot plates into position.

**FIG. E-Toe-in/Toe-out**-Loosen knobs underneath foot plates, slide foot plates into position.

**FIG. F-Abduction**-Loosen clamps to spread apart foot plates, tighten clamps. Loosen knobs under foot plates and slide foot plates apart.

Always tighten knobs securely.

## Knee Pads

**FIG. G**-The standard knee pads have depth, height and pad rotation adjustments only. To adjust the knee pads, loosen the knobs and move into position. Tighten securely once desired position is reached.

**FIG. H**-The Swing-Away Knee pads swing out of the way by depressing the red button, they also have width and height adjustments.

**⚠️ Caution:** Make knee pad adjustments while child is in the seated position only.

**FIG. A**  
Height

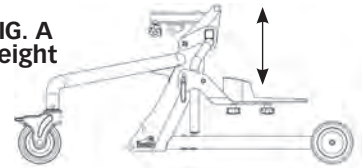

**FIG. B**  
Plantar/Dorsi

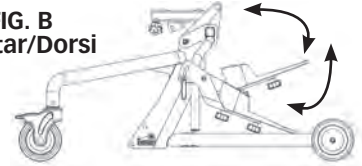

**FIG. C**  
Adduction

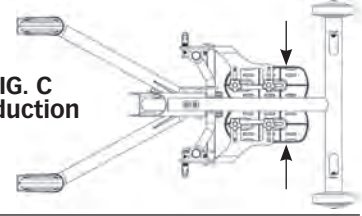

**FIG. D**  
Forward/Aft

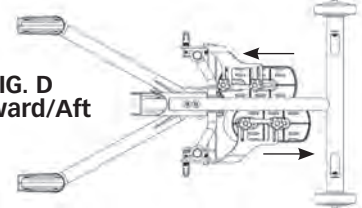

**FIG. E**  
Toe-in/Toe-out

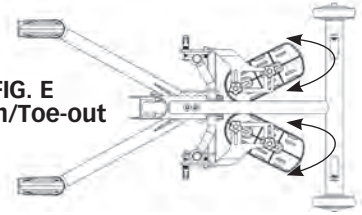

**FIG. F**  
Abduction

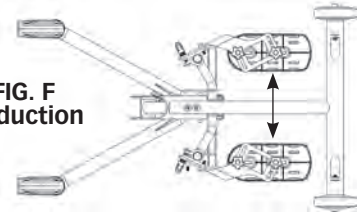

**FIG. H**  
Swing-Away Knee pads

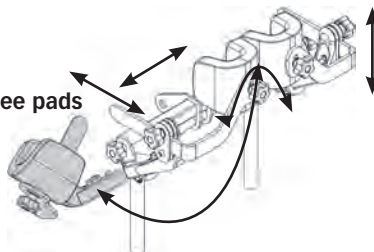

**FIG. G**  
Standard Knee pads

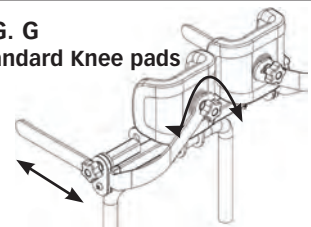

## Seat Depth/Back Angle/Back Height

⚠ **Caution:** Do not adjust the seat depth while the child is in the unit.

⚠ **Caution:** Ensure the colors on the seat tube and following arm match.

First remove the Shadow Tray and bring the seat up to a slight angle.

**34.** Loosen the knobs on the seat tube and the following arm. Do not unscrew knobs out all the way when adjusting the seat.

The Bantam **Extra Small** back angle adjustments are located above the locking knob. The back angle adjustments go from green (largest) to blue (smallest).

The Bantam **Small** back angle adjustments are located below the locking knob. The back angle adjustments go from blue (smallest) to green (largest).

**35. Adjusting to a shorter setting:** Adjust the following arm (back angle) first by depressing the spring button and moving no more than two holes at a time. Then adjust the seat tube (seat depth) one hole at a time. Continue this sequence until you achieve the desired setting and the colors on the seat tube and following arm match.

**36. Adjusting to a longer setting:** Adjust the seat tube (seat depth) first by depressing the spring button and moving only one hole at a time. Then adjust the following arm (back angle) no more than two holes at a time. Continue this sequence until you achieve the desired setting and the colors on the seat tube and following arm match.

**Note:** For easier adjustment you may need to lift slightly as the seat depth adjustment is made.

Tighten the seat depth and following arm knobs securely when you have achieved the desired position.



## Hip Supports/Lateral Supports Options

**37.** The optional hip supports can be removed for transferring. The hip support width can be adjusted by loosening the knobs underneath the seat. Always tighten securely.

The hip supports have a number of attachment holes on the back of the pad allowing for additional positions vertically and horizontally. The pads can also be bolted on at a straight, 90°, 180°, or 270° position.

**38.** The optional lateral supports can be removed for transferring. The lateral support width can be adjusted by loosening the knobs on the back of the unit. Always tighten securely.

The lateral supports have a number of attachment holes on the back of the pad allowing for additional positions vertically and horizontally. The pads can also be bolted on at a straight, 90°, 180°, or 270° position.

Please check for fit and interference by bringing the unit to the maximum standing position and back to sitting again (without a user seated in the unit) as the pads may not work perfectly in all positions.

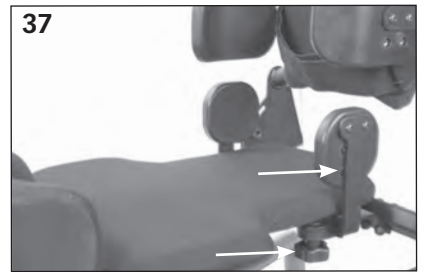

Hip Supports



Lateral Supports

## Accessories Mounting Bracket

**39.** The accessories mounting bracket is attached to the back of the unit and is used for a wide range of options. The holes in the middle can be used for many styles of aftermarket head supports. There are holes for the chest vests, chest straps, and lateral supports. This bracket is standard on all units.

## Attaching the Chest Vest

**40.** Insert chest vest clips into slots as shown with tab facing up.

**41.** Once the tab is past the bracket, pull back until snug.

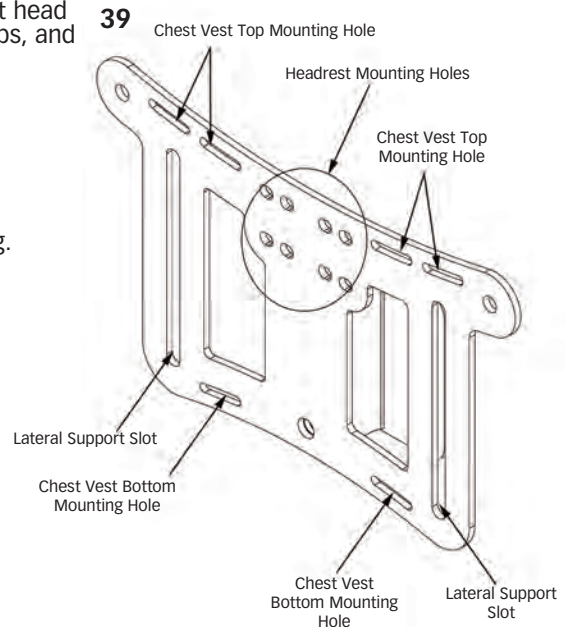
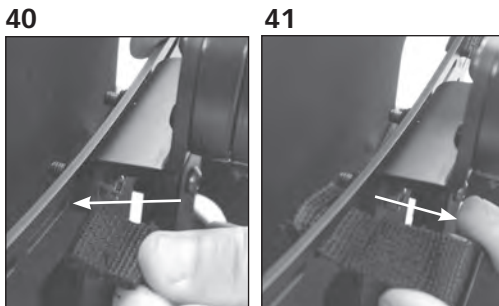

## Controller Usage

Designed with ease of use and the safety and comfort of the user in mind, the Controller (as shown) is the single point of operation for the supine option.

**42.** The Controller has 3 positions: Neutral, Sit-to-Stand, and Supine.

**43.** There is a spring loaded safety collar (red colored) which prevents inadvertent switching between modes. It must be lifted upward into the shift knob before the mode can be changed.

### Sit-to-Stand Mode

**44.** The unit is locked into sit to stand mode when the foot bracket is locked to the base frame.

Please note that even though the controller is set to sit to stand mode, the foot plate bracket must be brought perpendicular to the floor and locked into place. If the bracket is not already in position this can be accomplished by:

- Pushing the back all the way forward to the end of its range (approximately 90 upright).
- Pushing the footplate bracket all the way down and backward toward the base to the end of its range.

Listen for a clicking sound to indicate that the unit is locked into sit to stand mode.

If you can move the back support, or foot supports forward or backward, the unit is not yet locked in sit to stand mode.

The sit to stand mode allows the user to move between sitting and standing positions. The hip and knee pivot points articulate while maintaining constant angles for the back and foot support bracket.

**Important: All seat depth and following arm adjustments should be made with the Controller in the Sit-to-Stand mode.**

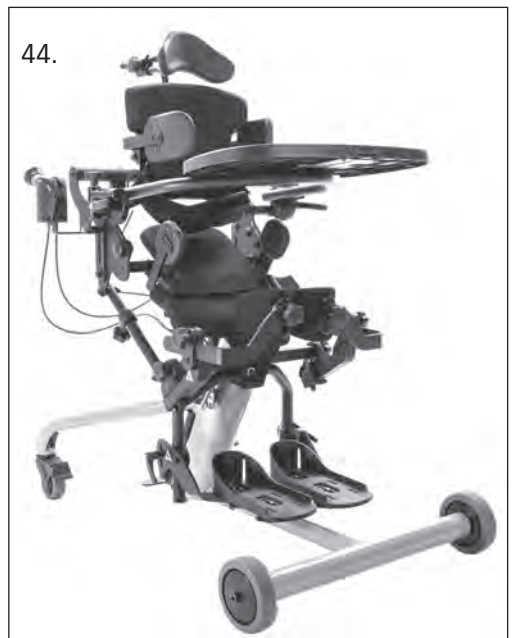

## Controller Usage

### Neutral Mode

**45.** The controller should only be set in the neutral position when changing between the sit to stand and supine positioning modes.

Do not leave the controller in neutral position with a person in the Bantam.

**46.** The neutral position allows the foot bracket supports, and the back support to move freely at the hip and knee pivot points to go into partial supine or full supine.

45

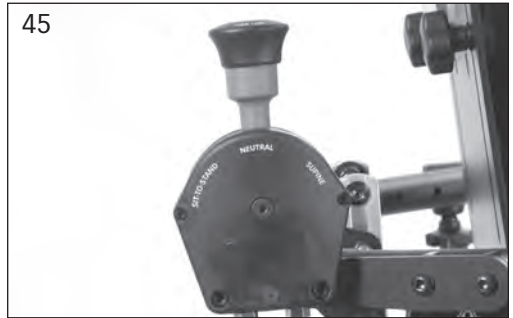

46



## Controller Usage

### Supine Mode

**⚠ Caution:** A properly fitted and adjusted headrest **MUST** be used with the supine option.

**47.** The unit is locked into supine mode as soon as the controller is set in that position.

The foot bracket supports and back support are locked in relation to each other in Supine mode. When in partial supine or full supine the user can be elevated to an upright position or descended to a reclined position.

**48.** If the unit is locked in supine mode, you must only elevate the unit to the point where the footplate bracket comes perpendicular to the floor.

**DO NOT CONTINUE TO ELEVATE THE UNIT PAST THIS POINT.** Forcing the unit to elevate past its stopping point could result in damage to the unit.

If the unit has a hydraulic pump or electric actuator, it is equipped with a Mechlok bypass. This mechanism prevents component damage in the event of over-travel while locked in "Supine" mode. If in supine mode with the legrest assembly up against the seat column (vertical), the Mechlok bypass will be activated. If you wish to maintain supine position while lowering the seat, it is necessary to pull on the supine assist handle a few degrees while lowering the unit until the mechlok bypass de-activates. If this is not done, the stander will behave as though it is in "Sit-to-Stand" mode, allowing the user to return to a seated position.

**⚠ Caution:** When in supine mode, if the limit is reached where the foot bracket is perpendicular to the floor, but the user wishes to continue to a straighter standing position you must change the controller to sit to stand mode. This will allow the user to continue toward upright standing without damaging the unit.

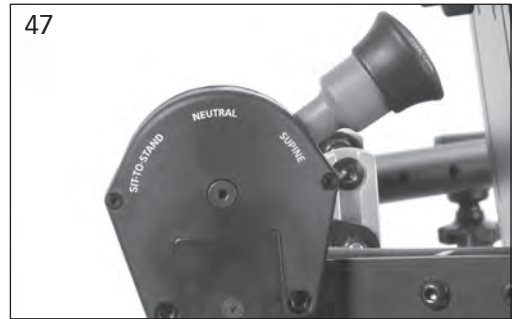

## Shadow Tray Adjustment

⚠ **Caution:** These adjustments are only to be made while the unit is in the seated position.

⚠ **Caution:** Always support the tray when loosening the ratchet handles to adjust the tray.

⚠ **Caution:** After placing the tray into position, ensure the ratchet handles on the side of the tray are tightened securely.

### Black Molded Tray and Clear Tray Depth

**49.** To adjust the depth of the optional tray, place tray tubes into the receptacles and line up holes to the desired depth, and insert pins.

**50.** To adjust the height of the tray, loosen both ratchet handles on the side of the unit and lift the tray to the user's desired height, tighten securely.

**51.** To adjust the angle of the tray, loosen both ratchet handles on the side of the tray and position the tray to the user's desired angle, tighten securely.

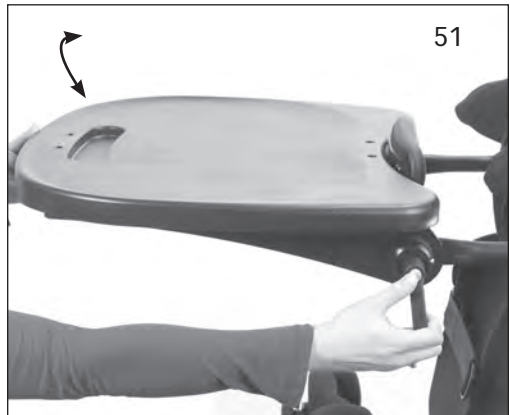

## Swing-Away Shadow Tray Adjustment

### Black Molded/Multi-Adjustable Tray Height

52. To adjust tray height, loosen knobs on the side of unit and set to desired position. Tighten securely

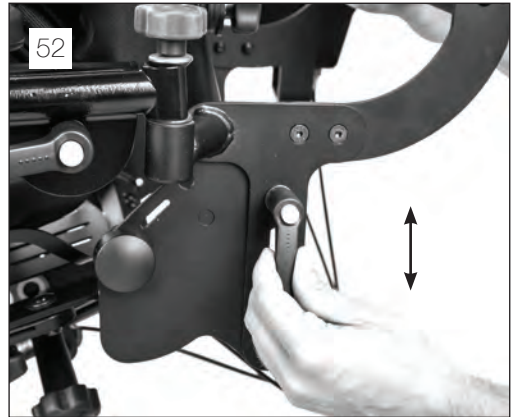

### Multi-Adjustable Tray Depth

53. Loosen knob under the tray, pull or push into desired position. Tighten securely.

### Multi-Adjustable Tray Angle

54. To adjust tray angle, loosen ratchet handles on both sides of the tray, set to desired position. Tighten securely.

⚠ **Caution:** These adjustments are only to be made while the unit is in the seated position.

⚠ **Caution:** Always support the tray when loosening the knobs or ratchet handles to adjust the tray.

⚠ **Caution:** After placing the tray into position, ensure the ratchet handles on the side of the tray are tightened securely.

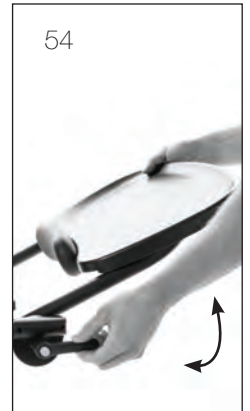

### Multi-Adjustable Tray Swing-Away

55. Loosen knob on one side only until you are able to swing tray away. Tray can swing both left and right.

56. Swing tray away to allow for transfers.

Note: To remove tray, loosen knobs on both sides of the tray.





## Head Support Adjustment

**57.** To adjust the head support height, loosen the knob on the back of the back option, move to desired position and tighten securely.

**58A.** To adjust the head support depth, loosen the knob on the back of the headrest and slide into desired position, tighten securely.

**58B.** To adjust the head support angle, loosen the ratchet handle and place into desired position. Tighten securely.

## Foot Plate Adjustment

**59.** Adjust the foot plate by loosening the ratchet handle on the foot plate, up or down and to the desired angle, tighten securely. Foot plates may be inverted for increased range.



# Pow'r Up Lift Option Usage

## Charging the Battery

The EasyStand Bantam Pow'r Up Lift uses two 12-volt sealed lead batteries rated at 2.9 amps each. An EasyStand Bantam can be lifted approximately 100 times on one full battery charge. An audible alarm will sound when the battery is low. Please charge the battery after the alarm sounds. A battery needing to be fully recharged will take approximately 8 hours. The EasyStand Bantam can be raised to the standing position while being charged. The function of the charger is to detect a full battery and then provide a constant potential power supply to hold the battery at a full condition without overcharging. When the battery EMF rises to a factory preset point, the charger circuit will not allow the peak output voltage to exceed that value. This factory setting protects a battery from excessive depletion of electrolyte, which can occur from overcharging. The charger can be found in the tool pouch on the back of the unit.

**CAUTION:** Use only the Linak charger, model number 10CH01S-00, provided by Altimate Medical with the Pow'r Up option.

1. Plug the receptacle into a wall outlet. The length of the charger cable is 80" (203cm). The light on the charger will be green indicating an open circuit.
2. **FIG. A-** Plug the charger cord into the side of the hand control. The light on the charger will turn yellow indicating the batteries are being charged. The length of the hand control cable is 30" (76cm), retracted.
3. **FIG. B-** The unit will arrive unplugged from the battery, plug in the white cord that supplies power to the actuator and the black cord that supplies power to the remote. The black cord has a notch on it to orient the connector properly. Fully charge battery before use.  
*Note:* The white cord has a rubber washer on it, which makes it very sticky and sometimes will not get pushed in completely, make sure to push the cord all the way into the battery.
4. When the batteries are charged, the light on the charger will turn green.
5. Fully charge the batteries every three months or less during periods of intermittent or non-use.

**CAUTION:** The Bantam Pow'r Up Option is not designed for continuous use. Duty Cycle 5% Max, 1 min. / 19 min.

**Raising the Lift** - Press the UP (arrow up) button on the hand control to lift the seat.

**Lowering the Lift** - Press the DOWN (arrow down) button on the hand control to lower the seat.

**CAUTION:** Ensure the cables are attached properly per the instructions for use. Do not allow the cables to drag on the floor or to catch on objects.

**FIG. A**

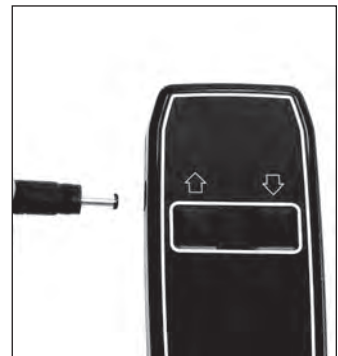

The hand control is a Type BF applied part.

**FIG. B**



## Activating the Mechanical Emergency Release

**⚠ CAUTION:** Using the emergency mechanical release as the primary means of returning to the seated position can cause damage to the unit. Only use the mechanical release in emergency situations.

All Altimate Medical electric lift products are equipped with a mechanical release to be used in emergency situations.

**FIG. C-**The release allows the user to be lowered to a seated position in the unlikely occurrence of the battery losing charge while the user is in a standing position. The actuator only retracts if the release is pulled and there is weight on the seat. The release is located on the left side of the seat and is signified by a red tag with the word "EMERGENCY."

1. To activate the emergency mechanical release pull out the quick release pin located underneath the seat.
2. Squeeze the handle and if necessary, push down on the handle.



**FIG. C**

## Battery Replacement

The batteries are enclosed in the control box of the Pow'r Up Lift (the black box where the cords are plugged in). Once the batteries have reached their end of life and need to be replaced, do not open the control box; please contact Altimate Medical Customer Service or your medical equipment dealer for information about purchasing a replacement control box. It is recommended that the batteries be replaced every four years.

Please contact a local recycling authority for information about disposing of the old batteries.

## IP Rating

The IP rating is a classification system indicating the protection degree from dust, water and impact for electrical equipment and enclosures. Pow'r Up Lift components are rated at IP21. The definition for IP21 is as follows:

**First character definition:** 2 - Protected against solid foreign objects of 12.5mm diameter and greater.

**Second character definition:** 1 - Protected against vertically falling water drops.

## Electromagnetic compatibility

Pow'r Up Option components have been designed and tested to meet the applicable EMC requirements. It is unlikely that you will encounter problems with your EasyStand due to inadequate electromagnetic compatibility. However, if you notice any unusual (such as intermittent) behavior of your Pow'r Up option and the EasyStand is being used next to possible interfering equipment such as mobile phones, microwaves, or radio broadcast masts, this could be an indication of electromagnetic interference. If such behavior occurs, use the mechanical release to lower the unit to the seated position and move the EasyStand away from the interfering equipment. Please report any instance of possible electromagnetic interference to AMI's Customer Service Department.

## Guidance and Manufacturer's Declaration - Electromagnetic Emissions

The EasyStand Bantam is intended for use in the electromagnetic environment specified below. The customer or the user of the EasyStand Bantam should assure that it is used in such an environment.		
Emissions Test	Compliance	Electromagnetic Environment - Guidance
RF emissions CISPR 11	Group 1	The EasyStand Bantam uses RF energy only for its internal function. Therefore, its RF emissions are very low and are not likely to cause any interference in nearby electronic equipment.  The EasyStand Bantam is suitable for use in all establishments, including domestic establishments and those directly connected to the public low-voltage power supply network that supplies buildings used for domestic purposes.
RF emissions CISPR 11	Class B	
Harmonic emissions IEC 61000-3-2	Class A	
Voltage fluctuations/ Flicker emissions IEC 61000-3-3	Complies	

## Guidance and Manufacturer's Declaration - Electromagnetic Immunity

The EasyStand Bantam is intended for use in the electromagnetic environment specified below. The customer or the user of the EasyStand Bantam should assure that it is used in such an environment.			
Immunity Test	IEC 60601 Test Level	Compliance Level	Electromagnetic Environment - Guidance
Electrostatic Discharge (ESD) IEC 61000-4-2	± 6 kV contact ± 8 kV air	± 6 kV contact ± 8 kV air	Floors should be wood, concrete, or ceramic tile. If floors are covered with synthetic material, the relative humidity should be at least 30 %.
Electrical Fast Transient/Burst IEC 61000-4-4	± 2 kV for power supply lines ± 1 kV for input/output lines	± 2 kV for power supply lines ± 1 kV for input/output lines	Mains power quality should be that of a typical commercial or hospital environment.
Surge IEC 61000-4-5	± 1 kV line(s) to line(s) ± 2 kV line(s) to earth	± 1 kV line(s) to line(s) ± 2 kV line(s) to earth	Mains power quality should be that of a typical commercial or hospital environment.
Voltage dips, short interruptions and voltage variations on power supply input lines IEC 61000-4-11	<5 % $U_T$ (>95 % dip in $U_T$ ) for 0,5 cycle 40 % $U_T$ (60 % dip in $U_T$ ) for 5 cycles 70 % $U_T$ (30 % dip in $U_T$ ) for 25 cycles <5 % $U_T$ (>95 % dip in $U_T$ ) for 5 s	<5 % $U_T$ (>95 % dip in $U_T$ ) for 0,5 cycle 40 % $U_T$ (60 % dip in $U_T$ ) for 5 cycles 70 % $U_T$ (30 % dip in $U_T$ ) for 25 cycles <5 % $U_T$ (>95 % dip in $U_T$ ) for 5 s	Mains power quality should be that of a typical commercial or hospital environment. If the user of the EasyStand Bantam requires continued operation during power mains interruptions, it is recommended that the EasyStand Bantam be powered from an uninterruptible power supply or a battery.
Power frequency (50/60 Hz) magnetic field IEC 61000-4-8	3 A/m	3 A/m	Power frequency magnetic fields should be at levels characteristic of a typical location in a typical commercial or hospital environment.
<i>NOTE: <math>U_T</math> is the a.c. mains voltage prior to application of the test level.</i>			

## Guidance and Manufacturer's Declaration - Electromagnetic Immunity

The EasyStand Bantam is intended for use in the electromagnetic environment specified below. The customer or the user of the EasyStand Bantam should assure that it is used in such an environment.

Immunity Test	IEC 60601 Test Level	Compliance Level	Electromagnetic Environment - Guidance
<p>Conducted RF IEC 61000-4-6</p> <p>Radiated RF IEC 61000-4-3</p>	<p>3 Vrms 150 kHz to 80 MHz</p> <p>3 V/m 80 MHz to 2.5 GHz</p>	<p>3 Vrms</p> <p>3 V/m</p>	<p>Portable and mobile RF communications equipment should be used no closer to any part of the EasyStand Bantam, including cables, than the recommended separation distance calculated from the equation applicable to the frequency of the transmitter.</p> <p>Recommended separation distance</p> $d = 1.2 \sqrt{P}$ <p><math>d = 1.2 \sqrt{P}</math> 80 MHz to 800 MHz</p> <p><math>d = 2.3 \sqrt{P}</math> 800 MHz to 2.5 GHz</p> <p>Where <math>P</math> is the maximum output power rating of the transmitter in watts (W) according to the transmitter manufacturer and <math>d</math> is the recommended separation distance in meters (m).</p> <p>Field strengths from fixed RF transmitters, as determined by an electromagnetic site survey<sup>a</sup>, should be less than the compliance level in each frequency range.<sup>b</sup></p> <p>Interference may occur in the vicinity of equipment marked with the following symbol:</p> <div style="text-align: center;">  </div>

*NOTE 1: At 80 MHz and 800 MHz, the higher frequency range applies.*

*NOTE 2: These guidelines may not apply in all situations. Electromagnetic propagation is affected by absorption and reflection from structures, objects, and people.*

<sup>a</sup> Field strengths from fixed transmitters, such as base stations for radio (cellular/cordless) telephones and land mobile radios, amateur radio, AM and FM radio broadcast and TV broadcast cannot be predicted theoretically with accuracy. To assess the electromagnetic environment due to fixed RF transmitters, an electromagnetic site survey should be considered. If the measured field strength in the location in which the EasyStand Bantam is used exceeds the applicable RF compliance level above, the EasyStand Bantam should be observed to verify normal operation. If abnormal performance is observed, additional measures may be necessary, such as re-orienting or relocating the EasyStand Bantam.

<sup>b</sup> Over the frequency range 150 kHz to 80 MHz, field strengths should be less than 3 V/m.

## Recommended separation distances between portable and mobile RF communications equipment and the EasyStand Bantam.

The EasyStand Bantam is intended for use in an electromagnetic environment in which radiated RF disturbances are controlled. The customer or the user of the EasyStand Bantam can help prevent electromagnetic interference by maintaining a minimum distance between portable and mobile RF communications equipment (transmitters) and the EasyStand Bantam as recommended below, according to the maximum output power of the communications equipment.

Rated maximum output power of transmitter  W	Separation distance according to frequency of transmitter m		
	150 kHz to 80 MHz $d = 1.2 \sqrt{P}$	80 MHz to 800 MHz $d = 1.2 \sqrt{P}$	800 MHz to 2.5 GHz $d = 2.3 \sqrt{P}$
0.01	.12	.12	.23
0.1	.38	.38	.73
1	1.2	1.2	2.3
10	3.8	3.8	7.3
100	12	12	23

For transmitters rated at a maximum output power not listed above, the recommended separation distance  $d$  in meters (m) can be estimated using the equation applicable to the frequency of the transmitter, where  $P$  is the maximum output power rating of the transmitter in watts (W) according to the transmitter manufacturer.

*NOTE 1: At 80 MHz and 800 MHz, the higher frequency range applies.*

*NOTE 2: These guidelines may not apply in all situations. Electromagnetic propagation is affected by absorption and reflection from structures, objects, and people.*

# Options & Parts Detail

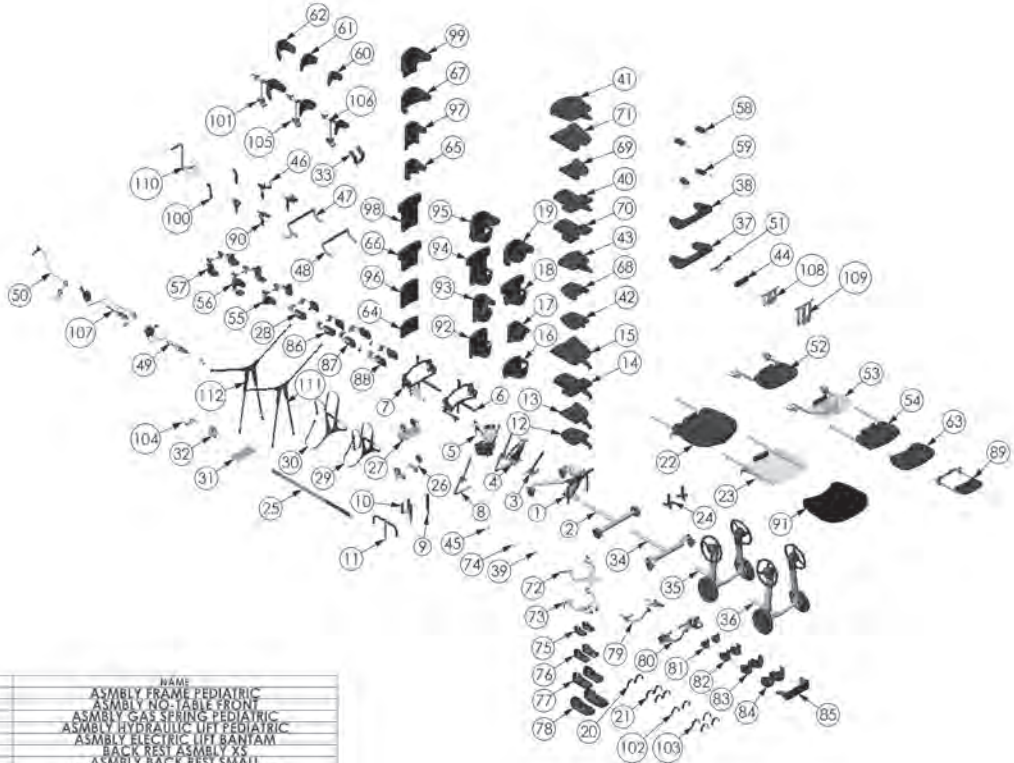

ITEM NO.	PART NO.	NAME
1	150000	ASSEMBLY FRAME PEDIATRIC
2	150018	ASSEMBLY NO. TABLE FRONT
3	150020	ASSEMBLY GAS SPRING PEDIATRIC
4	150020	ASSEMBLY HYDRAULIC LIFT PEDIATRIC
5	150100	ASSEMBLY BACK REST BANJAM
6	150100	BACK REST ASSEMBLY
7	150102	ASSEMBLY BACK REST SMALL
8	NC50328	HANDLE PUMP REMOVABLE/ADJ
9	NC50328	HANDLE STOP
10	NC50334	QUAD GRIP OPTION
11	NC50070	ACTUATOR HANDLE EXTENSION EVOLV LG
12	150024	ASSEMBLY SEAT FORM TO RL XS
13	150048	ASSEMBLY SEAT STANDARD SM
14	150048	ASSEMBLY UPHOLSTERY COMFY SEAT SM
15	150048	ASSEMBLY BACK REST STANDARD XS
16	150052	ASSEMBLY UPHOLSTERY FORM TO FIL BACK XS
17	150052	ASSEMBLY BACK REST STANDARD SM
18	150050	ASSEMBLY FOOT STRAP BACK SM
19	150052	ASSEMBLY FOOT STRAP PED
20	150052	ASSEMBLY FOOT STRAP SECURE PED
21	150052	ASSEMBLY TABLE STANDARD PEDIATRIC
22	150052	ASSEMBLY TABLE STANDARD PEDIATRIC
23	NC50042	SUPPORT GRIP OPTION
24	150059	POSITIONING BELT ADJUSTABLE 34.5 - 44.5"
25	150059	ASSEMBLY HIP GUIDES PEDIATRIC
26	150059	ASSEMBLY HIP GUIDES PED
27	150059	ASSEMBLY LATERAL GUIDES PED
28	150059	X-SHIELD CHEST VEST 7.5" X 9" W
29	150059	X-STYLE CHEST VEST 7.5" X 9" W
30	150059	TOOL FOULCH
31	80224	SEAT ANGLE LOCATOR
32	150128	ASSEMBLY HIGH MOUNT CHEST VEST BRKT
33	150114	ASSEMBLY SWIVEL CHAIR BANJAM
34	150150	MOBILE OPTION BANJAM
35	150177	MOBILE OPTION BANJAM LAIL
36	150120	ASSEMBLY ELBOW PAD IT CUTOUT
37	150120	ASSEMBLY ELBOW PAD IT CUTOUT
38	NC50499	ASSEMBLY BEARING SEAT DEPTH
39	150064	UPHOLSTERY SEAT STANDARD SM
40	150058	UPHOLSTERY SEAT STANDARD SM
41	150058	SEAT COVER STANDARD XS
42	150059	UPHOLSTERY SEAT COMFY XS
43	150044	PAD POINT BANJAM
44	150228	ASSEMBLY GAS SPRING LOW
45	150228	ASSEMBLY SHADOW SUPPORT TRAY PED
46	150212	HANDLE ASSEMBLY SUPINE
47	150212	HANDLE ASSEMBLY SUPINE
48	150239	SUPINE OPTION BANJAM BANJAM
49	150239	HAND ACTUATOR ASSEMBLY
50	150338	ASSEMBLY CHEST PAD MOUNT STANDARD
51	150338	ASSEMBLY CHEST PAD MOUNT STANDARD
52	150202	ASSEMBLY TRAY SWING AWAY CLEAR MPS
53	150202	TABLE STANDARD STOK 17"
54	150210	LATERALS W/ ELBOW STOP ARM REST 8"-12"
55	150220	ELBOW STOP W/ ARM REST
56	150249	ASSEMBLY FOREARM WINGS MPS
57	150249	ASSEMBLY FOREARM WINGS MPS
58	150353	SLIP COVER HEAD REST 5" X 10" W
59	150353	SLIP COVER HEAD REST 5" X 10" W
60	150354	PADDED HEAD COVER MAY INF
61	150373	SLIP COVER BACK 11" X 17"
62	150070	SLIP COVER BACK COMFY 15" X 17"
63	150070	SLIP COVER BACK COMFY 15" X 17"
64	150081	SLIP COVER BACK COMFY SM
65	150081	SLIP COVER SEAT STANDARD XS

ITEM NO.	PART NO.	NAME
66	150083	SLIP COVER SEAT COMFY XS
67	150083	SLIP COVER SEAT COMFY TO SM
68	150083	SLIP COVER SEAT COMFY TO SMALL
69	150230	FOOT PLATE STANDARD
70	150230	FOOT PLATE MULTI-ADJUST
71	150234	FOOT HOLDERS ASSEMBLY W
72	150234	FOOT HOLDERS 7.5" X 3.25" W
73	150234	FOOT HOLDERS 7.5" X 4" W
74	150234	FOOT HOLDERS 7.5" X 4" W
75	150234	KNEE STANDARD BANJAM
76	150244	SWING AWAY KNEES BANJAM
77	150248	KNEE PAD 3.75"
78	150270	KNEE PADS 4.25"
79	150272	KNEE PADS 5"
80	150248	ASSEMBLY KNEE PAD SOFT MPS
81	150272	ASSEMBLY LATERAL GUIDES PED
82	150272	ASSEMBLY LATERAL GUIDES PED
83	150272	ASSEMBLY LATERAL GUIDES PED
84	150249	MOBILE TABLE BANJAM
85	150014	ASSEMBLY SHADOW SUPPORT TRAY PED
86	150093	PADDED SLIP COVER LARGE TRAY
87	150240	BACK REST HIGH 15-17"
88	150240	ASSEMBLY UPHOLSTERY FORM TO FIL BACK HIGH XS
89	150242	ASSEMBLY BACK REST STANDARD HIGH SM
90	150249	SLIP COVER BACK COMFY HIGH SM
91	150090	SLIP COVER BACK COMFY HIGH XS
92	150090	SLIP COVER BACK COMFY HIGH SM
93	150090	SLIP COVER BACK COMFY HIGH XS
94	150090	SLIP COVER BACK COMFY HIGH SM
95	150282	TRAY HANDLE SUPPORT
96	150284	ASSEMBLY HEAD REST FORM TO FIL
97	150284	ASSEMBLY HEAD REST FORM TO FIL
98	150284	ASSEMBLY HEAD REST SM
99	150284	BRACKET CONTROLLER
100	150284	ASSEMBLY HEAD REST SM
101	150284	ASSEMBLY HEAD REST SM
102	150284	ASSEMBLY HEAD REST SM
103	150284	ASSEMBLY HEAD REST SM
104	150284	ASSEMBLY HEAD REST SM
105	150284	ASSEMBLY HEAD REST SM
106	150284	ASSEMBLY HEAD REST SM
107	150284	ASSEMBLY HEAD REST SM
108	150284	ASSEMBLY HEAD REST SM
109	150284	ASSEMBLY HEAD REST SM
110	150284	ASSEMBLY HEAD REST SM
111	150284	ASSEMBLY HEAD REST SM
112	150304	SUPINE OPTION W/ MFC LOCK BYPASS
113	150298	ASSEMBLY BACK REST BRACKET LOW
114	150298	ASSEMBLY BACK REST BRACKET HIGH
115	150298	ASSEMBLY BACK REST BRACKET HIGH
116	150302	NON-STRETCH X-SHIELD CHEST VEST 7.5" X 9" W
117	150302	NON-STRETCH X-SHIELD CHEST VEST 7.5" X 9" W
118	150304	NON-STRETCH X-SHIELD CHEST VEST 7.5" X 9" W
119	150304	NON-STRETCH X-SHIELD CHEST VEST 7.5" X 9" W
120	150304	NON-STRETCH X-SHIELD CHEST VEST 7.5" X 9" W

# Standing

## Contraindications

Standing/weight bearing may not be an option for the following reasons:

If the user has severe contractures or range of motion issues

If the user has severe osteoporosis or brittle bone disease

If the user has postural orthostatic hypotension

If the user has dislocated joints

 **Caution:** Consumers considering a standing program should consult with a qualified physician and medical team to determine what indications or contraindications exist. Clinicians must use best clinical judgment to evaluate the user's needs.

Implementing a standing program must be determined on an individual basis by the user's team (Physician, Physical or Occupational Therapist, Rehab Technology Professional/Supplier and the consumer). Consider all indications and contraindications for each client individually to determine if standing/weight bearing is appropriate for them.

## To Stand

 **Caution:** Always consult with a physician or therapist before starting a standing program.

 **Caution:** Never make adjustments to the EasyStand while a user is in the standing position.

 **Caution:** When lowering the unit from standing to sitting, keep all hands and feet clear of the mechanism beneath the seat.



# Maintenance

- Check the EasyStand at least weekly to ensure all nuts, bolts and adjustable parts are tightened securely, failure to do so may result in parts falling off which may cause a choking hazard for children.

## Cleaning/Disinfecting

- Clean the EasyStand Bantam with a mild, non-abrasive disinfectant or soap and water.
- Do not use bleach or any other bleach-based cleaners on the EasyStand.
- Disinfecting wipes are safe to use on metal and non-porous surfaces.
- Use a damp sponge with mild soap or a mild, non-abrasive disinfectant.
- Spot clean Neoprene with mild soap and water.
- Neoprene covers may be removed and hand washed with water. Air dry the covers. Always use care when removing and replacing the covers.
- Do not dry clean any upholstery items.
- If the EasyStand is being used with one user, clean the EasyStand on a monthly basis or as needed.
- If the EasyStand is being used in a multiple user environment, the EasyStand should be cleaned after each use.

## Urethane Coated Fabrics (Dartex or generic equivalent)

- The recommended cleaning and disinfection instructions should be followed whenever possible to avoid damage to the PU membrane which could lead to premature failure of the cover.
- For superficial dirt, use a disposable wipe and a warm solution of neutral detergent. Do not use abrasive cleaners.
- Disinfect using a 0.1% sodium hypochlorite solution (1000ppm chlorine), stronger bleach solutions not recommended.
- Thoroughly rinse any remaining cleaning solution with water and dry fabric before re-use or storage.
- Do not iron.

## Hydraulic Actuator Maintenance

- An initial break-in period of approximately 50-100 full cycles is normal for the hydraulic unit. You may experience a squeaking or a less-than-smooth forward stroke. The very close fit of its mating parts gives each actuator its own break-in "feel" and signature sound.
- If the pump is leaking oil or not holding properly contact your local EasyStand Supplier for a replacement. The serial number on the EasyStand will be needed.
- Do not exert excessive force on the actuator handle or use the actuator handle to move the EasyStand around. This may cause damage to the actuator handle and/or the actuator mechanism and will void any warranty.
- User maintenance is not required or recommended on the hydraulic actuator. Never apply lubricant, household oil, grease, or a similar product to any part of the unit. Some compounds may react with the seals used in the manufacture of this product. This may damage the unit and will void any warranty.
- Do not exceed the rated weight limit.
- If the EasyStand was shipped and exposed to a temperature of less than 50 degrees Fahrenheit, you must allow the hydraulic unit to warm to room temperature before use. Failure to follow this step could damage the unit and render it inoperable.
- Once a standing position is reached, the actuator may settle back one stroke, this is normal.
- It is not always necessary to push the actuator handle all the way back to lower the seat. If difficult to lower the seat, try pushing the handle back in different positions.
- If the unit is in the standing position and unoccupied, it is necessary to apply pressure to the seat of the unit while pushing the actuator handle back.

## Purging The Hydraulic Actuator

The hydraulic actuator on the EasyStand has a high probability of getting air trapped in the internal workings of the unit. This is usually caused by in-transit handling and is quite normal. Please follow the simple steps below, as manual hydraulic systems may never operate properly unless the entrapped air is correctly purged. The unit must be at room temperature for this procedure.

1. Pump the handle until the full extension is reached.
2. Continue pumping the handle slowly for an additional 10 strokes. This will properly purge the system.

# Troubleshooting

## **My lower leg length is too short for the stander.**

Invert and swap the foot plates left to right.

## **One of the arms on my tray is shorter than the other, is this correct?**

Yes, it is designed so you can line up the longer arm first, then the shorter arm.

## **We just received our Bantam and on the tray there is a quick pin to secure the tray in place, but there are two bolts attached on both sides. Am I suppose to use the bolts to secure the tray in place?**

The bolts and nuts are used as a tray depth guide. You can move them to any one of the holes on the tray adjustment arm depending on the person using the unit. To use, remove from the tray, position the tray with the correct depth and then reinstall in the hole closest to the tray top. This will stop the arms at the correct depth so it is easier and quicker when attaching the tray. To secure the tray, there are two quick pins attached to cables on both sides of the unit. Check both sides to make sure both are there. Sometimes, in shipping, they will move around, so at first glance only one side is visible.

## **How do I order parts?**

Contact your local supplier and have the serial number ready. If you don't know who your supplier is, call Altimate Medical Customer Service (800) 342-8968 and have the serial number ready.

# Limited Warranty

This warranty is extended only to the original purchaser/customer (or supplier non consumer who does not buy or resell). Altimate Medical, Inc., warrants the EasyStand Bantam against defects in materials and workmanship as listed below.

- Steel Frames - 5 year warranty
- Hydraulic Actuator - 2 year warranty
- Upholstered components, plastic pads, rubber parts, painted surfaces, bearings and other parts not specifically identified above - 90 day warranty

Warranty on Electric lift option components is as follows:

- Actuator & Hand Pendant – 2 year warranty
- Control Box & Battery – 90 days
- Battery Charger – 90 days

The warranty period commences on the original ship date from Altimate Medical. Any product proven to Altimate Medical satisfaction to be defective and within warranty period, shall be repaired or replaced at Altimate Medical's option.

ALTIMATE MEDICAL SOLE OBLIGATION AND YOUR EXCLUSIVE REMEDY UNDER THIS WARRANTY SHALL BE LIMITED TO SUCH REPAIR AND/OR REPLACEMENT. This warranty does not include any labor charges incurred in replacement parts installation. Freight charges to factory are at the expense of consumer to seller. Return freight charges will be prepaid by Altimate Medical. For warranty service, please contact the authorized supplier from whom you purchased your Altimate Medical product. In the event you do not receive satisfactory warranty service, please write directly to Altimate Medical at the address below. Do not return products to our factory without prior authorization.

LIMITATIONS AND EXCLUSIONS: The foregoing warranty shall not apply to serial numbered products if the serial number has been removed or defaced. Products subject to negligence, abuse, misuse, improper operation, improper maintenance, improper storage, or damages beyond Altimate Medical's control are not covered by this warranty, and that evaluation will be solely determined by Altimate Medical. Products modified without Altimate Medical's express written consent (including, but not limited to, modification through the use of unauthorized parts or attachments) are not covered by this warranty. The warranty shall not apply to problems arising from normal wear or failure to follow instructions. The warranty will be void if parts not manufactured by Altimate Medical or parts not complying with original equipment specifications are added to an Altimate Medical product.

THE FOREGOING WARRANTY IS EXCLUSIVE AND IN LIEU OF ALL OTHER EXPRESS WARRANTIES. ALTIMATE MEDICAL SHALL NOT BE LIABLE FOR ANY CONSEQUENTIAL OR INCIDENTAL DAMAGES WHATSOEVER.

Altimate Medical maintains a policy of continual product improvement and reserves the right to change features, specifications, and prices without prior notification. Check with Altimate Medical for latest information.

Altimate Medical, Inc., 262 W. 1st St., Morton, MN 56270 USA  
Phone: 507•697•6393 Fax: 507•697•6900 800•342•8968  
easystand.com info@easystand.com

## Environmental Issues

After life of the product:

- Recycle in accordance with the recycling codes of your country.
- Recycle all metal parts.
- Plastic parts should be disposed of or recycled according to the directive in your country.
- Please inquire at your local disposal management and recycling center for local codes.
- Return hydraulic actuator or damping cylinder (Pow'r Up only) to Altimate Medical, Inc.



# AltimateMedical

262 West 1st St.

Morton, MN 56270 USA

Toll Free: 800.342.8968 or 507.697.6393

Fax Free: 877.342.8968 or 507.697.6900

email: [info@easystand.com](mailto:info@easystand.com)

[easystand.com](http://easystand.com)

**EasyStand**  <sup>®</sup>   
standing made easy



Standing technology should only be used under the guidance of a physician with recommendations for standing program protocol and any medical precautions. Standing programs should be monitored by the attending therapist. Altimate Medical maintains a policy of continual product improvement and reserves the right to change features, specifications, and prices without prior notification. Check with Altimate Medical for latest information. FORM MBANEX-SMALL 101619 REV C Copyright © 2019 Altimate Medical, Inc. All rights reserved. Printed in the U.S.A.