

## Quick Start Guide

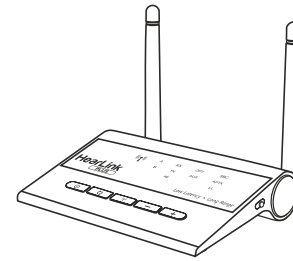

## 1 Package Contents



HearLink Plus device

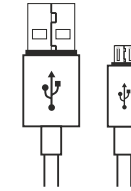

USB power cable

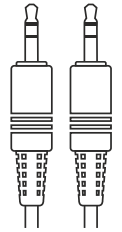

3.5mm stereo audio cable

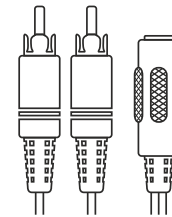

RCA-to-3.5mm adapter

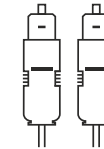

Optical fiber audio cable



This quick start guide

## 2 Device Details

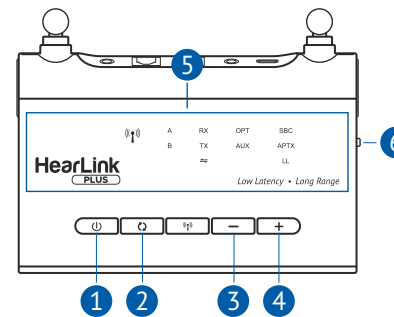

- 1 - Power button
- 2 - Bluetooth function button
- 3 - Previous track/volume down
- 4 - Next track/volume up
- 5 - Front display panel with LED indicators
- 6 - Mode switch

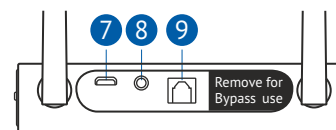

- 7 - Micro USB power input
- 8 - AUX stereo input
- 9 - Optical input

### 3 Setting Up HearLink PLUS

1. Connect HearLink PLUS to a power outlet (A) or the TV set's USB port (B) using the supplied USB power cable. HearLink PLUS will turn ON automatically.

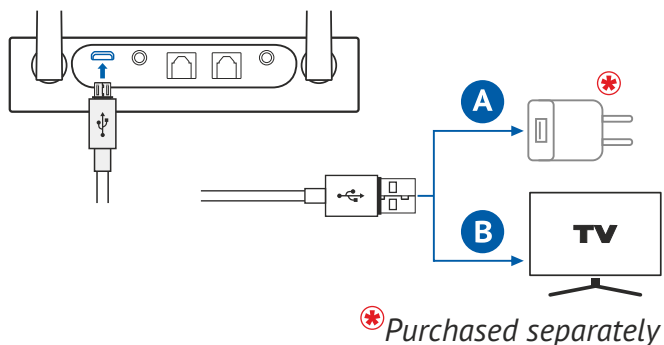

2. Ensure that the Mode switch is set to the **TX** position.

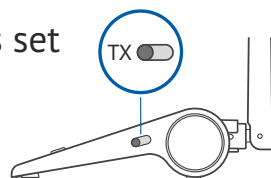

3. Connect the HearLink PLUS TX port to the TV (or other media device) via the supplied optical or 3.5mm audio cable.

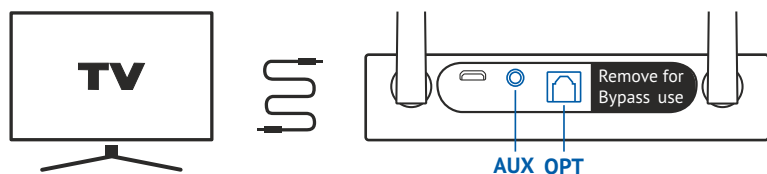

Make sure to remove the plastic protectors from the optical cable terminals prior to insertion.



The active connection type is indicated by the illuminated text (**OPT** or **AUX**) on the HearLink PLUS front display panel.

### 4 First Time Connection

1. Place HearLink PLUS into pairing mode with a short press on its button. When in pairing mode the **TX** indicator light will flash quickly.
2. Place your Bluetooth headset in “pairing” mode. Refer to the headset’s technical documentation for pairing instructions.
3. Place the Bluetooth headset close to the HearLink PLUS device.

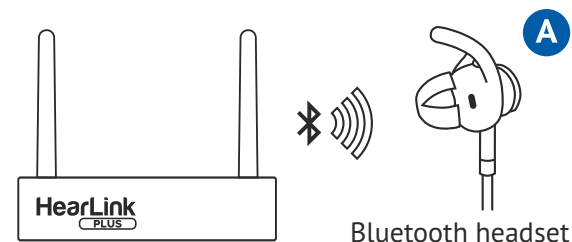

4. When pairing is complete (after 5-30 seconds) **TX** will be illuminated on the HearLink PLUS front display panel.

The **LL** is illuminated to indicate that the Low Latency APTX-LL Bluetooth CODEC is being used.

Successful connection of the headset is indicated by the illuminated **A** on the HearLink PLUS front display panel.





Subsequent connections should be automatic. If not, for BeHear headsets, a short press on the headset's **Power button** should re-establish the connection.

## 4 Audio Playback

### 1. HearLink PLUS Manual Control

 Short press to toggle audio **Play/Pause**.

 Press to **increase** the volume. A tone is played when maximum volume is reached.

 Press to **decrease** the volume. A tone is played when minimum volume is reached.

### 2. Bluetooth Headset Remote Control

Manage audio play using the headset's controls.

 Short press the multifunction button to toggle **Play/Pause** audio.

 Press volume up button to **increase** the volume.

 Press volume down button to **decrease** the volume.

#### **For BeHear headsets only:**

 To toggle between two connected audio sources (e.g., HearLink PLUS and a smartphone), simultaneously short press the headset's volume up and volume down buttons.

## 5 Helpful Information

### 1. If you do not hear audio:

- Ensure that the 'audio out' port of your TV (or other media device) connected to the HearLink PLUS is active. For some devices you need to enable the audio output. Refer to your device's user manual.
- Toggle the Play/Pause button on the headset or  button on the HearLink PLUS.

### 2. Use the HearLink PLUS **Bypass** mode to maintain the existing interfaces between your TV and peripheral audio equipment.

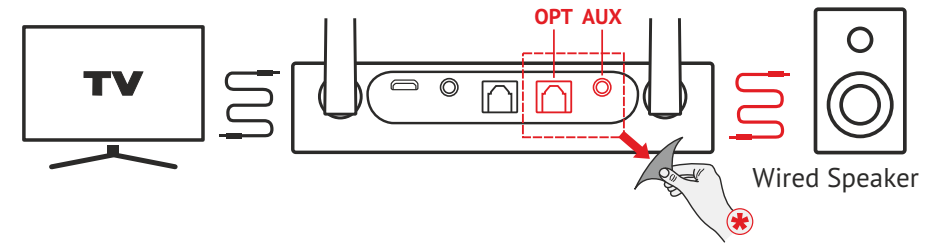

 Remove the sticker to expose the **RX** ports.

Connect the HearLink PLUS **TX** port to the TV via the optical or 3.5mm audio cable, and the **RX** port to a speaker or other peripheral audio equipment using the same type of cable as the TX port connection.

To passthrough HearLink PLUS set its Mode switch to **Bypass** position, indicated by . To restore connection with the headset set the Mode switch to **TX**.

