

Molift QuickRaiser 205

EN - User manual

molift[®]
a part of Etac

BM13001 Rev. A 2017-01-17



English Manual

Content

| | |
|--|----|
| Molift QuickRaiser 205 | 2 |
| Lifter components..... | 2 |
| About Molift QuickRaiser 205 | 2 |
| General..... | 3 |
| Declaration of conformity..... | 3 |
| Conditions for Use | 3 |
| Warranty | 3 |
| Product identification..... | 3 |
| Technical Data..... | 4 |
| Assembly | 5 |
| Battery | 5 |
| Leg support..... | 5 |
| Lifting column | 5 |
| Lifting arm..... | 6 |
| Mains cable..... | 6 |
| Hand control | 6 |
| Checklist after installation | 6 |
| How to use Molift QuickRaiser 205..... | 7 |
| Before use / Daily check | 7 |
| Hand control | 7 |
| Safety devices..... | 8 |
| Steering handles | 8 |
| Brakes | 8 |
| Emergency Stop / Emergency lowering | 8 |
| Electronics..... | 9 |
| Transport and Operating conditions..... | 9 |
| Battery | 9 |
| Battery and Service indicator | 9 |
| Charging | 10 |
| Transfer..... | 11 |
| Using Slings | 11 |
| Adjusting leg support | 11 |
| Using a 4-point lifting arm | 12 |
| Using a 2-point lifting arm | 12 |
| Raising | 13 |
| Transfer | 13 |
| Accessories | 14 |
| Suspensions and Slings..... | 14 |
| Leg Straps..... | 12 |
| Maintenance | 15 |
| Cleaning and disinfection | 15 |
| Reconditioning..... | 15 |
| Recycling | 15 |
| Spare Parts | 15 |
| Periodic Inspection | 15 |
| Periodic Inspection Scope | 15 |
| Troubleshooting | 16 |

Important

This user manual contains important safety instructions and information regarding the use of the lifter and accessories.

In this manual the user is the person being lifted. The assistant is the person operating the lifter.



Warning!
This symbol indicates important information related to safety. Follow these instructions carefully.



Read User Manual before use!
It is important to fully understand the content of the user manual before attempting to use the equipment.

Download documentation at www.etac.com to ensure you have the latest version.

Molift QuickRaiser 205

Components:

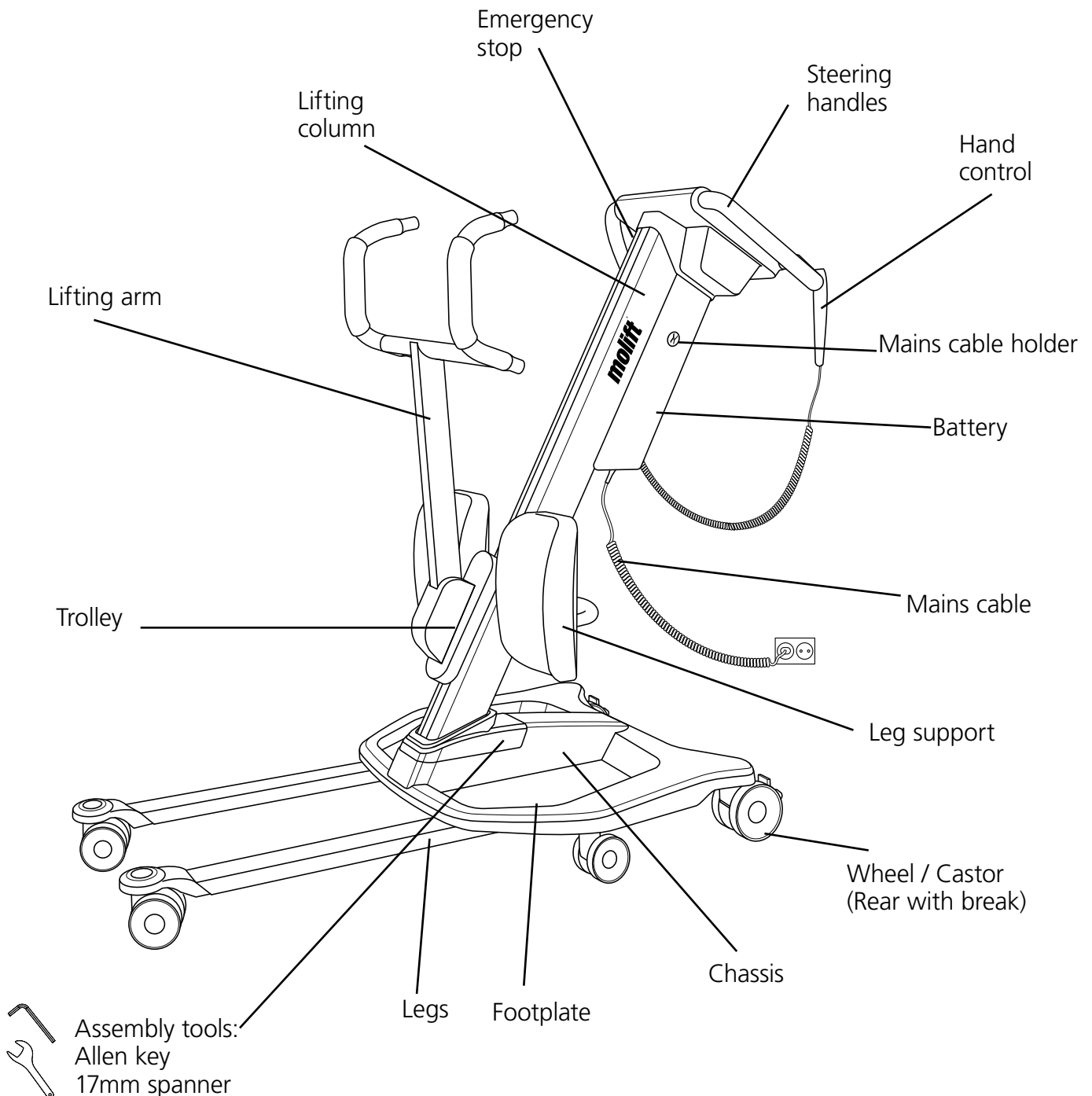

About Molift QuickRaiser 205

Molift QuickRaiser 205 is a sit-to-stand mobile lifter intended for raising and transferring a person from/to a chair, wheelchair or toilet with a sling. The shape of the lifter and geometry of the lifting movement imitates the natural pattern of movement of a person. The lifter is made of light-weight materials, has castors, and an electric motor powered by a battery. The hoist is operated by using the hand control or the control panel on

the hoist. It has electrically adjustable legs and with a lifting capacity of 205 kg (451lbs). It is ideal for institutional care settings but can also be used in private homes and nursing homes. The lifter should only be used for transfers across short distances, such as between a chair and a bed or into bathroom / rest room, and is not a replacement for wheelchair or similar.

General

Declaration of conformity



The Molift QuickRaiser 205 and related accessories described in this operator manual are CE marked in accordance with EU Council Directive 93/42/EEC concerning medical devices, class 1, and has been tested and approved by a third party according to standards IEC 60601-1, IEC 60601-1-2 and NS-EN ISO 10535:2006.

Conditions for Use

Lift and transfer of a person will always pose a certain risk and only trained personnel are allowed to use the equipment and accessories covered by this user manual.

Modifications and use of components made by other manufacturers.

We recommend only using Etac Molift components and spare parts. Declaration of conformity is not valid and Etac is not responsible for warranty if any modifications are made to the product. Etac shall not be liable for faults or accidents that can occur when using components made by other manufacturers.



Only certified personnel are allowed to open lifter or accessories to perform service or repair. Risk of injury from rotating parts and electric shock.



The lifter shall not be operated by the person being lifted.

Warranty

2-year warranty against defects in workmanship and materials of our products. For Terms and conditions, see www.etac.com

Product identification

Product label / GS1-128

The barcode label contain EAN number, serial number and production date.

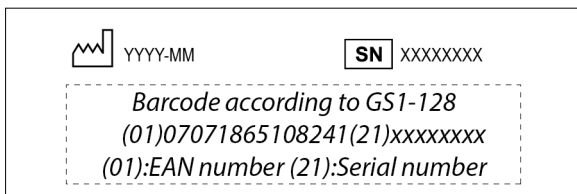
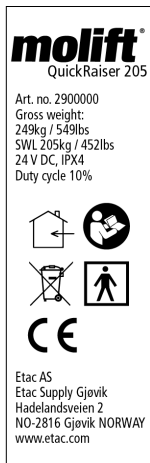

Type BF applied part



CE marked



Refer to user manual



Indoor Use only



Do not dispose in general waste



Emergency lowering



Service indicator



Battery indicator



Charging indicator

Warning labels and Symbols

Symbols used on the product, explained in more detail:

Technical Data QuickRaiser 205

Safe Working Load (SWL):

205 kg (451 lbs)

Weight of unit:

Total weight of unit: 44,5 kg/98 lbs

Chassis: 17 kg/37,5 lbs

Lifting column: 19 kg/41,9 lbs

Leg support: 3,5 kg/7,7 lbs

4-point lifting arm: 5 kg/11 lbs

Battery:

24 V SLA 2.9 Ah

Battery charger:

Input: 100-240 VAC, 50-60 Hz, max 0.35 A

Output: 29.4 VDC, 0,5 A

Lifting speed:

35mm/second (1,4 inches/second)
with 75kg (165 lbs) load

Protection class:

Hand control IPx4

Lift motor IPx4

Operating forces button:

Buttons on control panel: < 5 N

Buttons on handset: < 5 N

Material:

Aluminum, Plastic, steel

Motor:

Lifting motor: 24 V DC

Leg spreading motor: 24 V DC

Turning diameter:

1144 mm (57 inches)

Expected Lifetime:

The lifter has an expected lifetime of 30 000 cycles or 10 years.

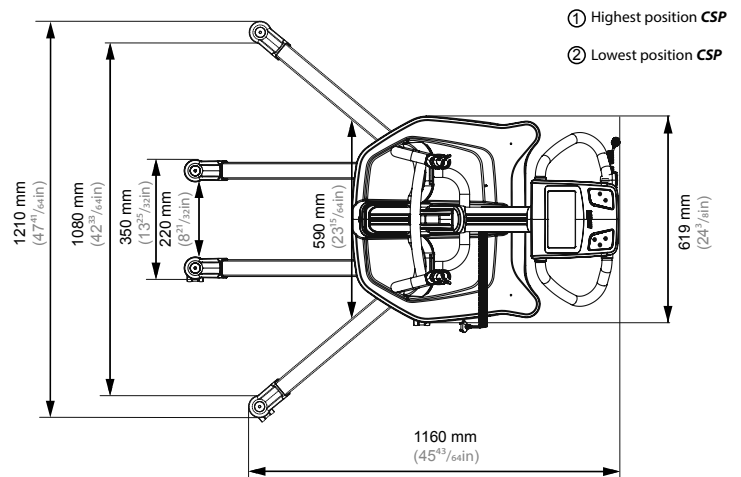
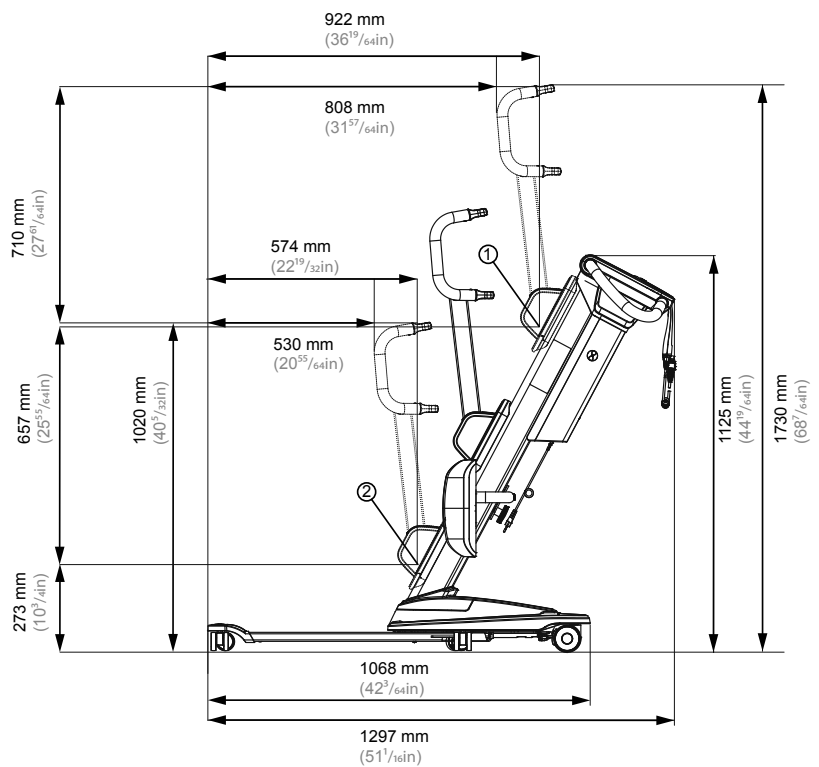

Assembly



Only trained personell shall assemble the lifter



All screws with pre applied threadlock must only be used once.

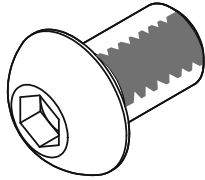

Push in the emergency stop button

Battery

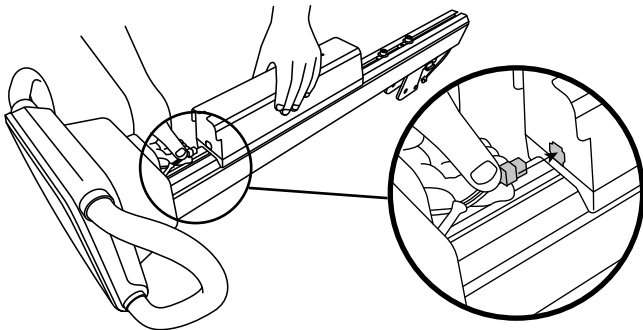

Place the column on a horizontal surface. Make sure the emergency stop is pushed in. Connect wire from control panel to battery box.

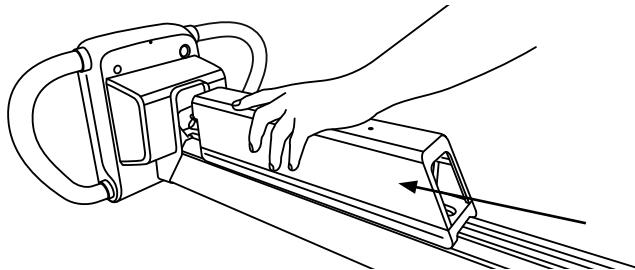

Slide the batterybox all the way in.

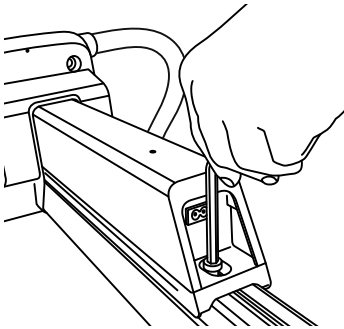

Use the allen key and tighten screw clockwise.



Make sure the battery is properly fastened before mounting the column in the chassis

Leg support

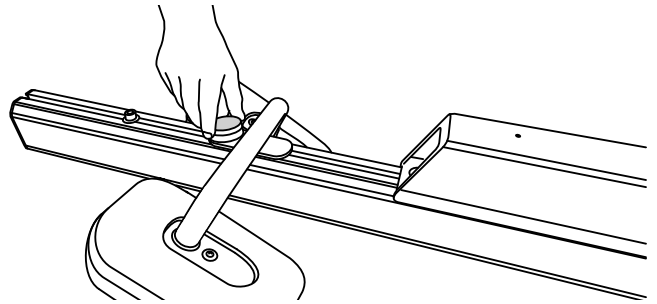

Mount the leg support bracket. Make sure the turning knob is mounted in the correct direction.

Lifting column

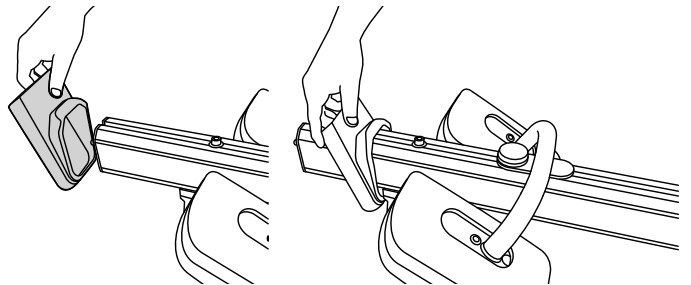

Place the cover on to the lifting column.

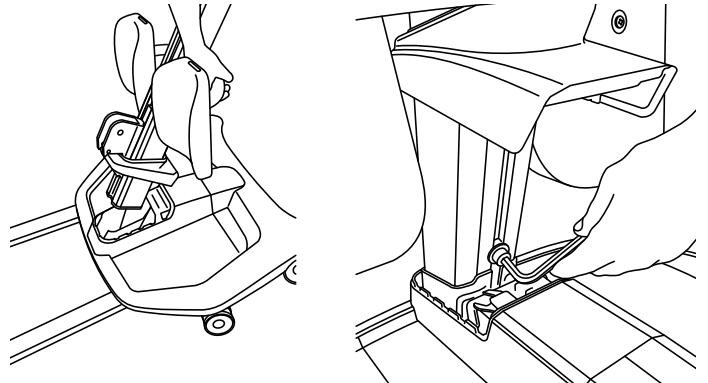

Place the lifting column into the chassis and tighten the first screw at the bottom of the column.

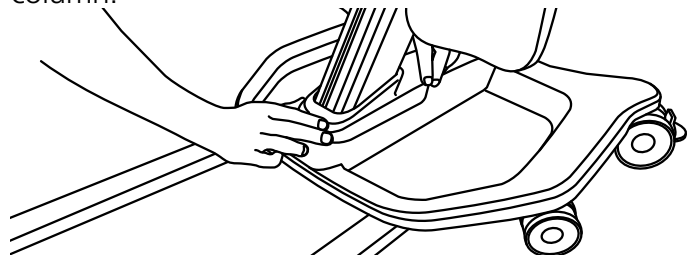

Fit the cover on to the chassis.

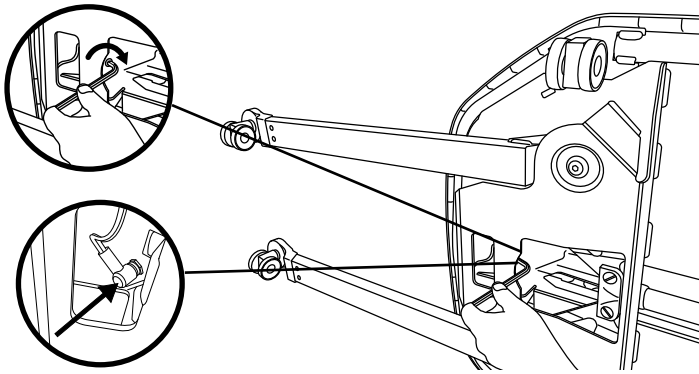

Turn the lifter over on the side. Tighten the second screw from the chassis into the column and connect cable between column and chassis.

 Screws will ensure that the column cannot be pulled upwards. Do not use lifter unless both screws are securely fastened.

Lifting Arm

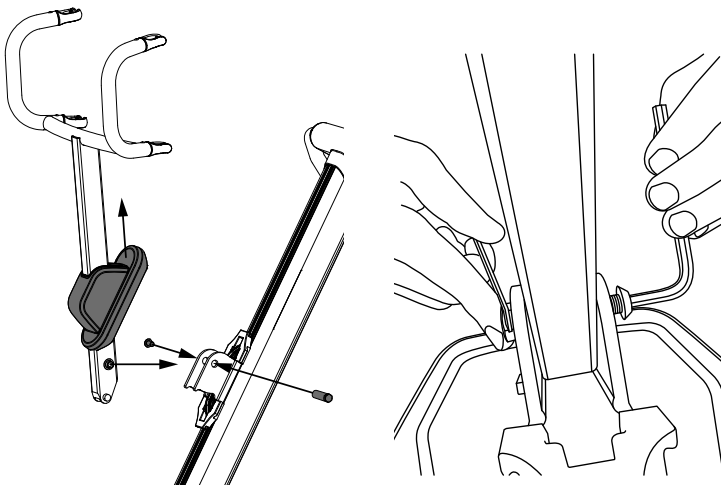

Make sure the lifting arm is properly fastened to the trolley on the column. Insert the bolt and tighten the screw using the 17mm spanner and an allen key.

Mains cable

Connect the mains cable to the bottom of the battery box.

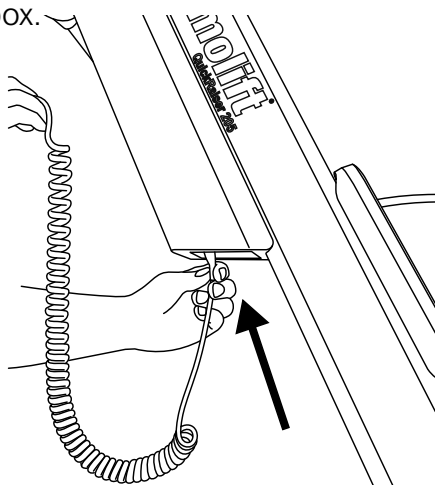

Hand control

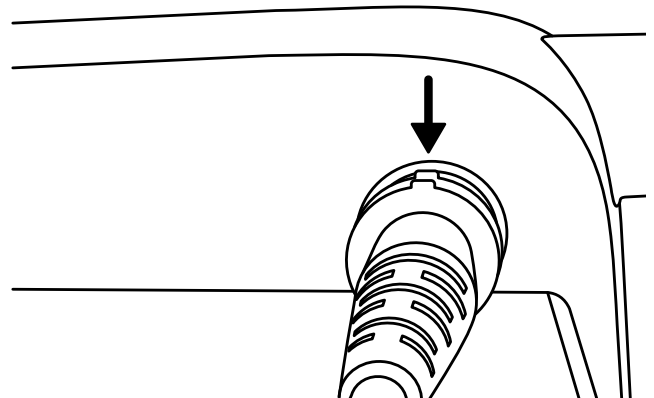
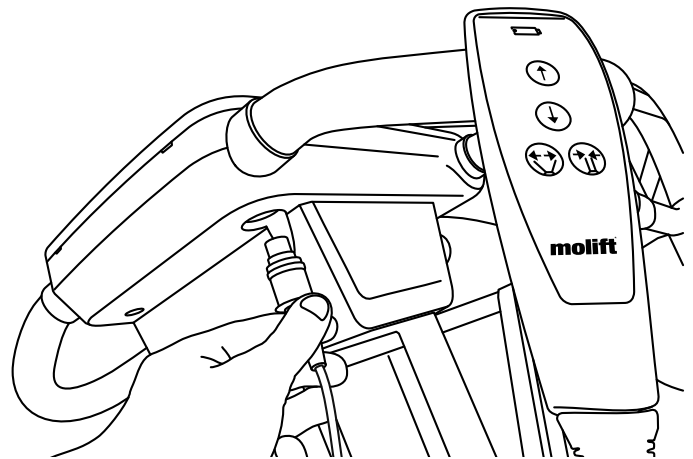

Connect the hand control to the control panel.

Checklist after assembly

 Do not start using lifter before completing control according to checklist after assembly.

Use this checklist to verify that the lifter is properly installed and can operate correctly and safely before use.

- Ensure that the lifting column, leg support and lifting arm are properly fixed and that there are no loose parts on the lifter.
- Verify that the lifting column is properly placed into the chassis - with both screws tightened.
- Make sure battery is charged
- Check that the lifter has no apparent damage or other faults.
- Perform one lift with normal load (60-80 kg)
- Reset service indicator as described in "periodic inspection"

How to use Molift QuickRaiser 205

General Safety Precautions

Only use accessories and slings that are adjusted to fit the user, type of disability, size, weight and type of transfer.

Working pause ratio/Duty Cycle.

Molift QuickRaiser 205 should not be run constantly for more than 2 minutes (with maximum load), and rest for minimum 18 minutes. Duty Cycle 10%. (Intermittence according to standard ISO-EN 10535)

Safe Working Load

The lifter is marked with Safe Working Load (SWL)



If maximum load (SWL) differs between lifter suspension and body support unit, then the lowest maximum load shall always be used



Molift lifters shall only be used to lift persons. Never use the lifter to lift or move objects of any kind.

Before use / Daily check

Inspection to be performed daily or before use:

- Make sure lifter has no visible damage, defects or deformations
- Make sure lifting arm connection, leg support, battery box and all detachable parts are properly connected and secured
- Test emergency stop button
- Check battery level and service indicator
- Make sure sling strap does not have visible damage or frays.
- Make sure wheels are rolling freely and lifter is easy to manoeuvre

- Test run lifters operation functions and make sure lifter does not make any abnormal sounds



If there are any faults or defects, the lift needs to be taken out of operation and marked "out of order"

Hand control

The hand control has 4 buttons for lifting and lowering of lifting arm and leg spread mechanism in and out.

The hand control has an indicator light that will illuminate when battery level is low and the lifter requires charging

Hand control 4 buttons
Art. no. 2910010

Lifting Arm - Up / Down

NB! The lifter is most unstable in top position.

Legs - In / Out

NB! Spreded legs gives increased stability and better access to chair or toilet.

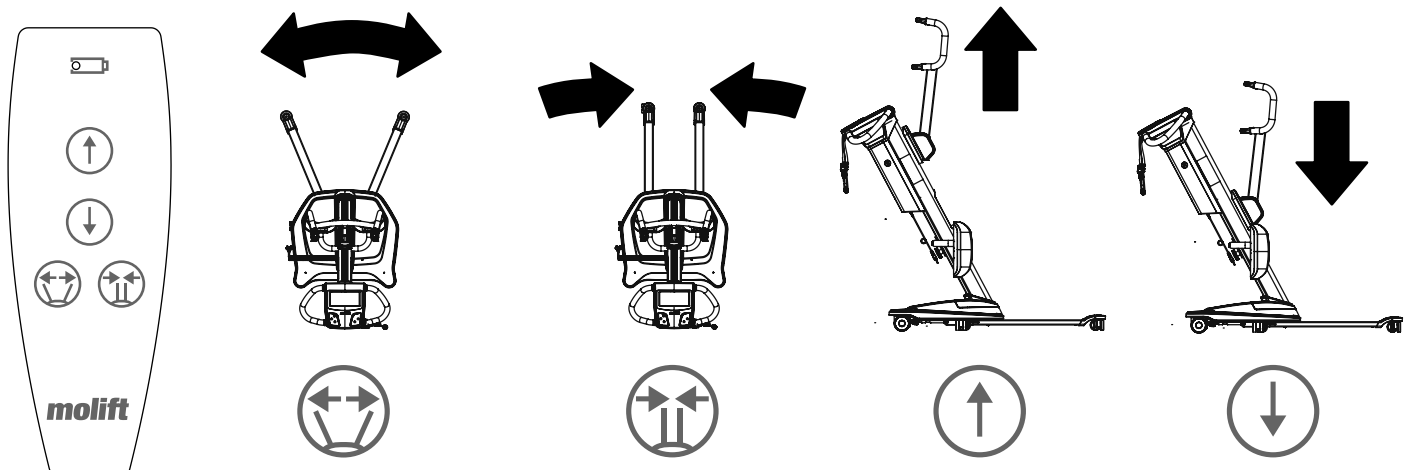

Safety devices

Molift QuickRaiser 205 is equipped with several safety devices, which are intended to prevent injury to personnel or damage to the equipment in the case of incorrect use or failure

The lifter has an overload sensor preventing the lifter to be operated if the load exceeds SWL.

The suspension is hinged to prevent the arm and suspension from squeezing the user.

Steering handles

Use the steering handles to move the lifter.



Do not push or pull the user, lifting column or lifting arm. This may cause stability problems and lifter may tip over.

The lifter shall only be used for transfer over short distances. It is not a replacement for wheelchair or similar.

Brakes

Rear wheels/castors are equipped with kick brakes. Step on the break to lock brakes. Push up or kick on top part of the brake to unlock.

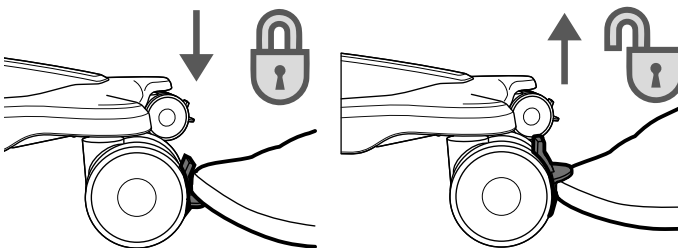

Emergency stop / Emergency lowering

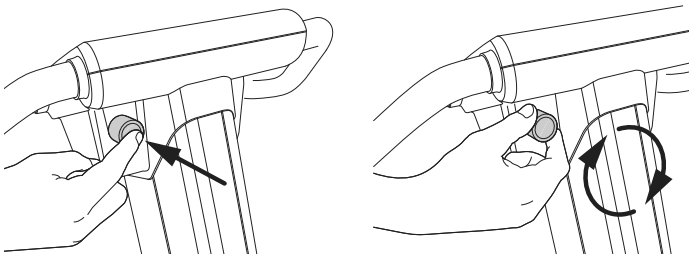

Emergency Stop

The emergency stop shuts off the power when pushed in. Turn clockwise to reset.

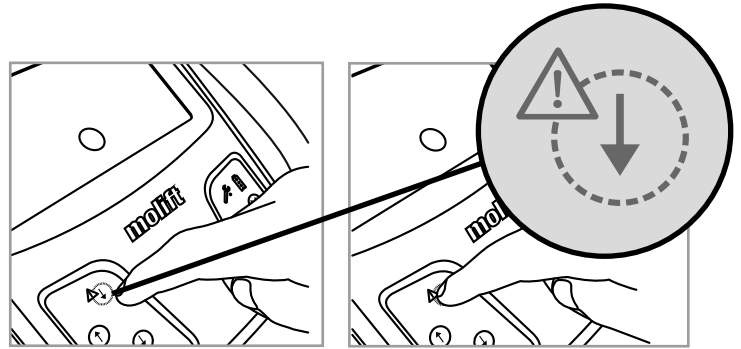

Electrical Emergency Lowering

Push and hold button for electrical emergency lowering to lower suspension. The electrical emergency lowering function does not work when the emergency stop is activated.



Only use the electrical emergency lowering if no other button works.

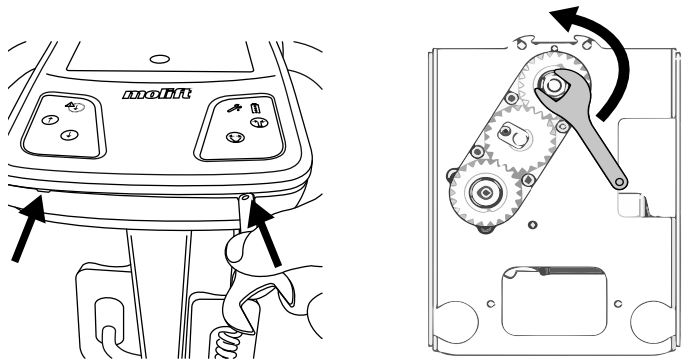

Manual Emergency lowering

Use the wrench located in the bottom cover to flip the control panel cover off at the two points.



Push in the emergency stop button before removing the cover. Disconnect the mains cable before manual emergency lowering.

Use the 17mm spanner and turn ball screw counter clockwise until the user is safely lowered. The manual emergency lowering function should only be used when the electrical emergency lowering does not work.



If emergency lowering is used, mark the lifter "out of order" and order service!



Rotating parts represents a squeezing hazard!

Electronics

Transport and operating conditions

Transport and Storage

For long time storage it is recommended that the emergency stop button is activated (pushed in). The lifter can be stored and transported under temperatures between -25 - 70 °C.

Operating

The lifter is designed for use at standard room temperatures (+5 to +40°C).
 Air Pressure: 70 - 106 kPa
 Relative Humidity: 15 - 93 %
 Storage or transport at other temperatures leave the lifter in a room with a suitable temperature until it reaches a safe operating temperature.



Medical electrical equipment requires special precautions regarding electromagnetic compatibility (EMC). Portable or mobile radio communication equipment may affect the medical electrical equipment, and should be kept minimum 25 cm (10 inches) from the lifters electronics.



Battery

Molift QuickRaiser 205 is available with a 24V SLA battery and has an integrated charger. The battery has a life expectancy of approx. 500 charge cycles.



Batteries must be disposed of as special waste according to local rules and regulations. Do not dispose in general waste







Battery and Service indicator

| | |
|--|------------------------------------|
|  | Wrench symbol / Service indicator |
|  | Battery symbol / Battery indicator |

The electrical system has a power-save function which will turn off the electrical system five minutes after last operation. All indicators will turn off. The system is activated when pushing one of the operating buttons

Battery indicator

When the multi level battery indicator is yellow the lifter will have sufficient power available for one full lifting cycle with max load. When battery is flashing yellow it is only possible to lower the lifting arm.

| <i>Battery indicator</i> | | <i>Battery level</i> |
|---|-----------------|-------------------------------|
|  | Green | 80% or more |
|  | Green | 80 - 60% |
|  | Green | 60 - 40% |
|  | Green | 40 - 20% |
|  | Yellow | 20% or less (recharge lifter) |
|  | Yellow flashing | 0% (recharge lifter) |

Service indicator

The lifters electronics record the weight lifted and number of lifts. After a certain period of operation a signal is given to indicate that service is required.

| <i>Service light</i> | <i>Mode</i> |
|----------------------|------------------------------|
| No light | No service needed |
| Yellow flashing | Periodic inspection required |
| Yellow | Order service |
| Red | Perform service |

Charging

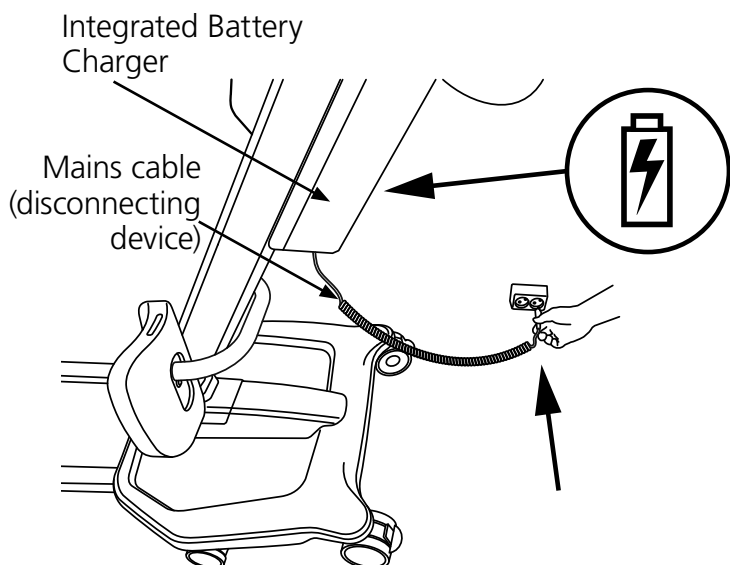

The lifter has an integrated charger. Park the lifter and connect to a wall socket to charge the battery. Lights on battery will be red while charging. Lights on battery will show a steady green color when lifter is charged.



Do not charge the lifter in a bathroom or in any room with wet surfaces!



Remove the main cable from the wall socket outlet before moving the lifter

Transfer

Plan the lifting operation in advance to ensure that it is as safe and smooth as possible. Remember to work ergonomically. Assess the risks and take notes. The assistant is responsible for the safety of the user.

Using Slings

It is important that the sling has been tested with the individual user and for the intended lifting situation.



Read User Manual for the sling prior to use.



Do not to use damaged or badly worn slings.

Slings made by other manufacturers
 Only use Molift slings. Etac shall not be liable for faults or accidents that can occur when using slings made by other manufacturers.

Adjusting leg support

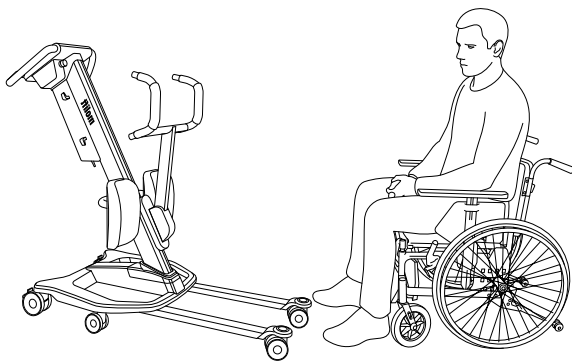

Move the QuickRaiser 205 in front of the user. Place the feet on the footplate. If necessary - help the user to place the feet correctly. Lock the wheels on the lifter before lifting the user.

The optimal angle of the users joints before lifting is 90 degrees.



Make sure the height of the leg support are adjusted to fit the individual users anatomy.

Use the knob to adjust the leg support higher or lower if necessary.

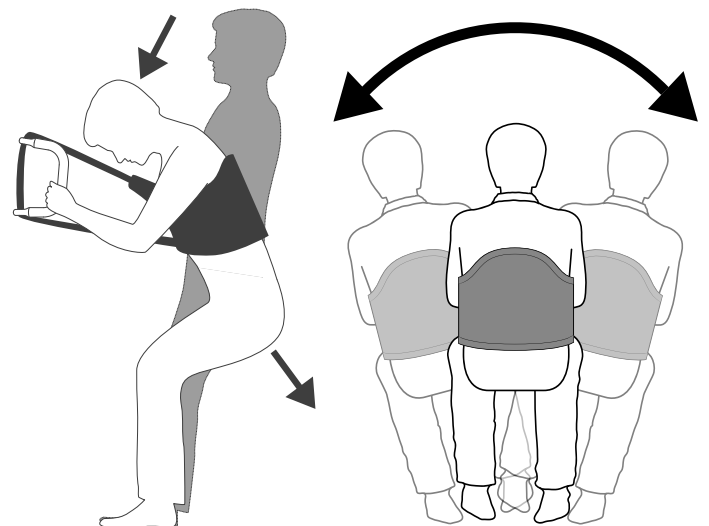
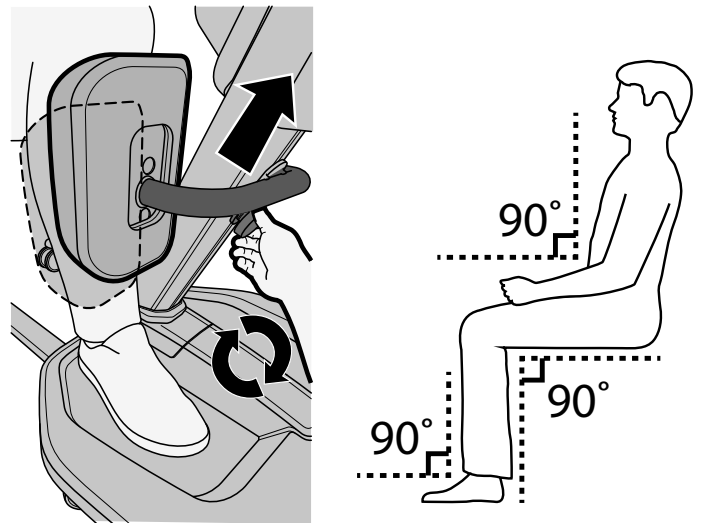



Make sure the user is not hanging forward or swinging to the sides under and before lifting or lowering the user.

Using a 4-point suspension

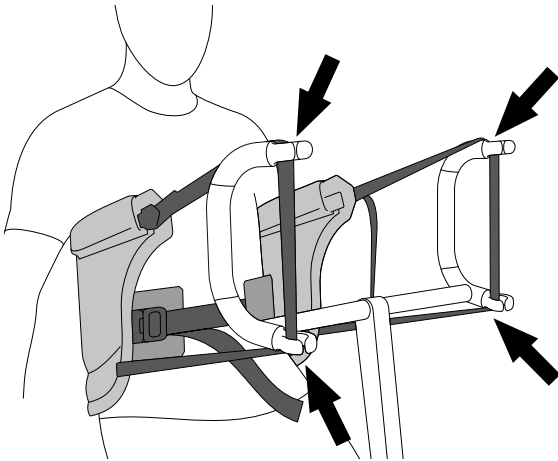

Fasten the sling to the lifting arm by guiding the strap into all 4 hooks.

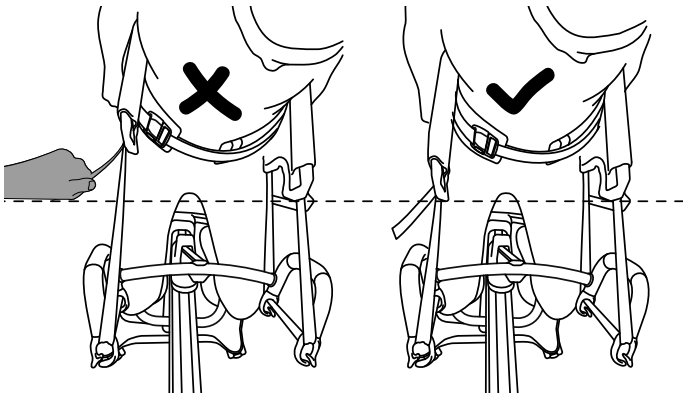

Pull the loose strap to adjust the length of the straps. Make sure both sides have equal length.

The patient's weight ensures that the strap locks into the lifting arm. The user must lean back slightly when lifting, and if possible hold onto the handles.

Removing sling

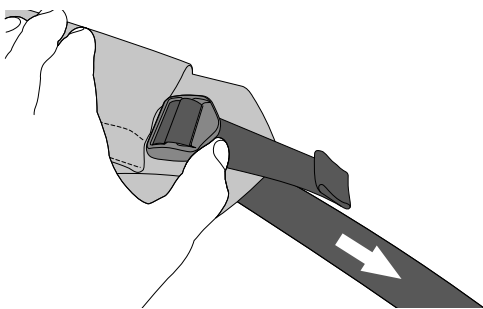

Loosen the straps again by angling the buckle and pulling the strap out.

Using a 2-point suspension

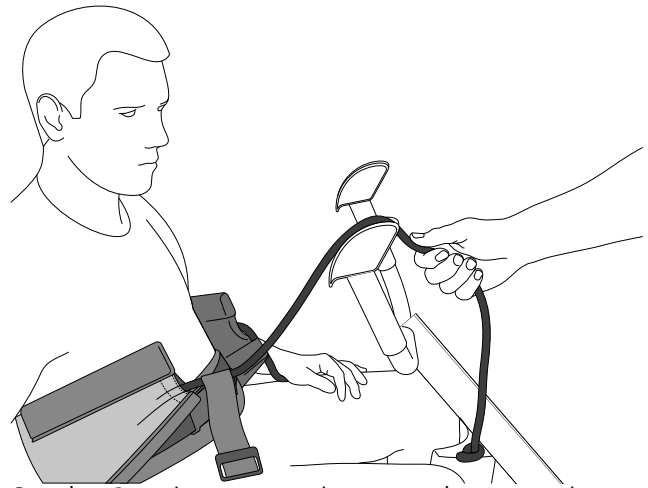

On the 2-point suspension arm the ropes is attached to the lifting arm by pulling them firmly from above and into the rope locks.

Removing sling

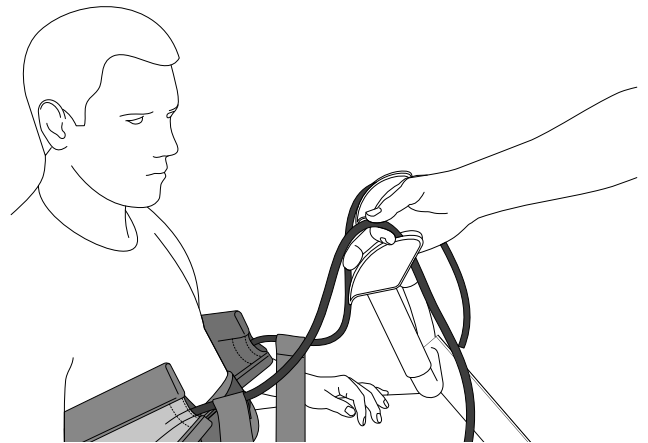

Release the band by sliding your fingers along the rope away from the patient.



RgoSling Active can only be used with the 4-point suspension.
RgoSling Stand Up can only be used with the 2-point suspension.

Raising/Lowering

When moving the user, stand to the side of the person you are lifting. Make sure that arms and legs do not obstruct the seat, bed, etc. Keep eye contact with the user to help them feel safe.

If possible: Extend the width of the wheel base prior to lifting using the button for base width adjustment on the Hand control.

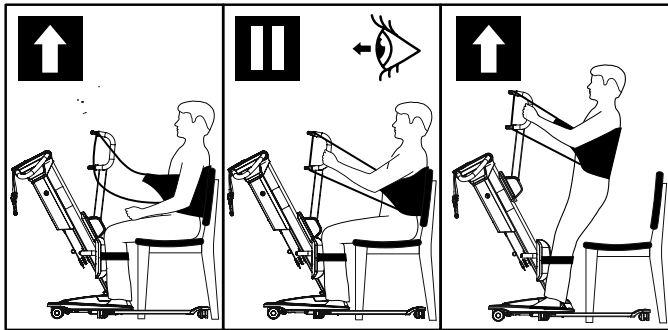

1. Check that the sling is correctly fitted around the user and that the strap loops are correctly fitted to the suspension hooks.
2. Make sure user has both feet placed firmly on the footplate on the lifter.
3. Stretch the sling straps without lifting the user. Ensure that both loops of the sling are securely fastened to avoid the user slipping or falling.
4. Make sure the buckle is properly fastened
5. Lift user to standing position, and tighten and adjust the sling if necessary.

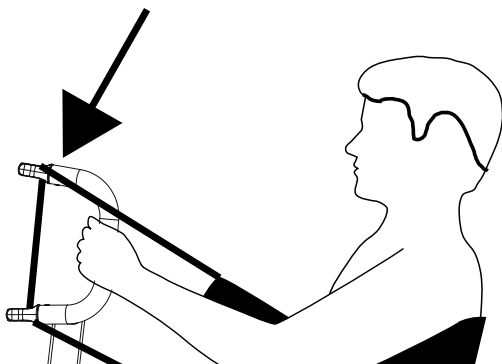

Make sure the users hands are placed correctly to avoid that the lifting straps are squeezing the users hands and fingers.

NB! The wheels of the object the user is being lifted from or into must be in the locked position.

Transfer

Raise the patient carefully until the buttocks are clear from the seating and tighten the belt. Unlock the wheels on the lifter and move the patient to the next location.

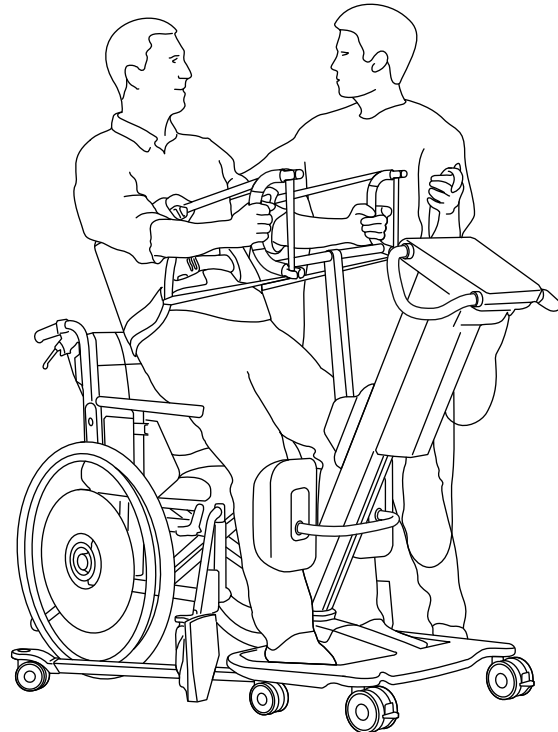

Be careful during movement not to run into furniture, walls, doors etc.



The lifter shall not be used to lift or move users on sloping surfaces

Avoid deep pile carpets, high thresholds, uneven surfaces or other obstacles that may block the castors. The lifter may become unstable if forced over such obstacles increasing the risk of tipping over.

The lifter shall only be used for movement over short distances. It is not a replacement for wheelchair or similar.

Accessories

(Recommended) optional equipment and accessories for Molift QuickRaiser 205.

Accessories

Extension for power cord
Art. no.: 2920117

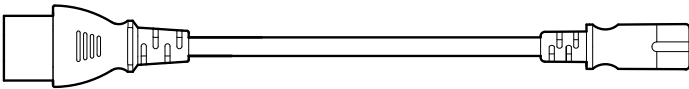

Set of inlay for footplate
Art. no.: 2920151

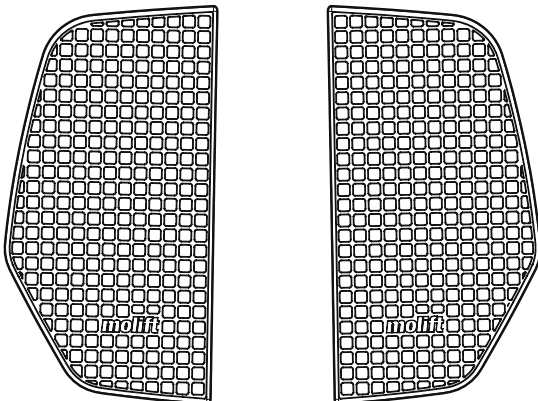

Lifting arms and slings

4-point suspension

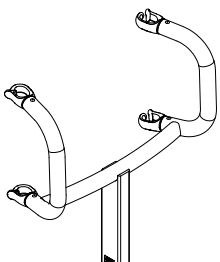

QuickRaiser Active lifting arm
Art. no.: 2910060

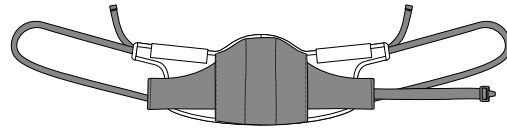

Rgosling Active

| | |
|-------------------|---------|
| Art. no.: 1720910 | Size XS |
| Art. no.: 1720920 | Size S |
| Art. no.: 1720930 | Size M |
| Art. no.: 1720940 | Size L |
| Art. no.: 1720950 | Size XL |

2-point suspension

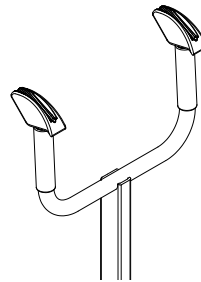

QuickRaiser Stand Up lifting arm
Art. no.: 2910061

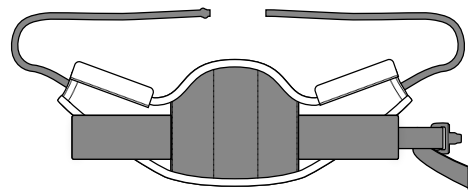

Rgosling Stand Up

| | |
|-------------------|---------|
| Art. no.: 1720710 | Size XS |
| Art. no.: 1720720 | Size S |
| Art. no.: 1720730 | Size M |
| Art. no.: 1720740 | Size L |
| Art. no.: 1720750 | Size XL |

Rgosling Stand Up Padded

| | |
|-------------------|---------|
| Art. no.: 1720810 | Size XS |
| Art. no.: 1720820 | Size S |
| Art. no.: 1720830 | Size M |
| Art. no.: 1720840 | Size L |
| Art. no.: 1720850 | Size XL |

Maintenance

Cleaning and disinfection

Clean on a regular basis. Clean surfaces with a damp cloth using an appropriate pH-neutral detergent. Do not use solvents or strong liquids, this may damage surfaces on the lifter. For disinfection when needed; use isopropyl alcohol. Avoid abrasive cleaning products.

- Remove lifting arm cover to clean underneath
- If necessary, remove the control panel cover to clean inside
- If necessary, remove the leg support and clean it with running water
- Remove hair and pile from the castors and verify that the castors rotates freely.

Clean contact and hand control with isopropyl alcohol to remove grease and dirt if necessary. Check emergency stop after cleaning. The lift should not be exposed to running water.



Make sure not to damage or remove labels when cleaning.

Reconditioning

Follow cleaning and assembly procedure, complete periodic inspection and use checklist after assembly to recondition the lifter.

Recycling

Refer to "Recycling instructions" for how to properly dispose of product. See www.etac.com.

Spare Parts

A list of spare parts is available on request.

Periodic Inspection

Periodic Inspection Scope

Periodic inspection is a visual examination (particularly of the lifter's load bearing structure and lifting mechanism with attachments, brakes, controls, safety devices and person-support devices) according to Periodic Inspection Report for Molift QuickRaiser 205. See www.etac.com.



In the event of danger to safety, the lifter shall immediately be taken out of service and marked clearly with "out of order" and shall not be used until the lifter is repaired

Periodic Inspection shall be performed at least once a year or more frequently if required by local requirements. The inspection must be performed by service personnel authorized by Etac. Contact Etac at molift@etac.com for training and authorization or recommendation of an approved service partner.

When performing a periodic inspection, the inspector shall fill out the inspection report for Molift QuickRaiser 205. The reports should be retained by the person(s) responsible for servicing the lifter. If the inspection reveals defects and damages, the lifter shall be taken out of operation and marked "out of order" until it is repaired. After performing periodic inspection reset the service indicator

Reset service indicator

Reset the service indicator by pushing in and holding "up" and "down" on the control panel for 5 seconds. A green light will blink for 5 seconds, immediately after this light starts to blink push in and hold both "in" and "out" for five seconds. You will hear two short beeps. The service light will no longer flash. It will start to flash again when one year has passed and it is time for new periodic inspection.

Troubleshooting

| Symptom | Possible Cause/Action |
|--|--|
| The lifting column is wobbly | Locking bolts are not properly secured or lifting column is not properly in place in the chassis / check if the column is correctly placed in the chassis and/or tighten bolts |
| Lifter only moves one way (up or down) / legs only moves one way (in or out) | Fault on hand control / exchange with alternative control from other lifter and/or new hand control |
| | The electronics has failed / contact your local service representative |
| The lifter moves up and/or down by itself / legs move by themselves | Short circuit between the hand control and lifter / clean the connectors of the hand control and chassis with spirits to remove grease and dirt |
| | The hand control has failed/ exchange hand control / contact your local service representative |
| | Relays/electronics malfunctions / exchange electronics/relays / contact your local service representative |
| The lifting arm does not move / legs does not move | Discharged battery / charge battery |
| | Emergency stop activated / turn clock wise to reset |
| | Hand control disconnected / reconnect hand control |
| | The hand control has failed/ exchange hand control / contact your local service representative |
| | Electronics malfunctions / contact your local service representative |
| | Motor has failed / contact your local service representative |
| | Check contact between column and chassis |

molift[®]
a part of Etac