



Solace In-Floor Dialysis Scale

with Wi-Fi and Bluetooth 5.0

Owner's Manual

INTRODUCTION

Thank you for purchasing our Detecto Solace In-Floor Dialysis Scale. The Solace series in-floor scales are ideal for dialysis clinics, emergency rooms, and clinical facilities where fast, efficient patient measurement is necessary. The Solace series is flush-mounted with the floor and include the pit frame and trim ring, plus an interface cable from the scale to the indicator. These in-floor scales are covered with durable stainless steel to provide years of maintenance-free use. The built-in thermal printer makes it easy to print out a weight record for patient record keeping, providing you with a complete in-floor scale package for continuous patient weight monitoring. The high 1,000-lb capacity and up to 6 ft x 4 ft platform sizes allow them to be used for wheelchair, bariatric, and even stretcher weighing. A tubular handrail with a padded handgrip is available on some models for walk-on patients.

This manual is provided to guide you through the setup and operation of your scale. Please read it thoroughly before attempting setup or to operate your scale and keep it available for future reference.

This manual is for the following models of the Solace In-Floor Dialysis Scales:

| | | | |
|------------------|------------------|------------------|------------------|
| ID-3636S-855RMP | ID-4836S-855RMP | ID-4848S-855RMP | ID-7248S-855RMP |
| ID-3636SH-855RMP | ID-4836SH-855RMP | ID-4848SH-855RMP | ID-7248SH-855RMP |

COPYRIGHT

All rights reserved. Reproduction or use, without expressed written permission, of editorial or pictorial content, in any manner, is prohibited. No patent liability is assumed with respect to the use of the information contained herein.

DISCLAIMER

While every precaution has been taken in the preparation of this manual, the Seller assumes no responsibility for errors or omissions. Neither is any liability assumed for damages resulting from the use of the information contained herein. All instructions and diagrams have been checked for accuracy and ease of application; however, success and safety in working with tools depend to a great extent upon individual accuracy, skill, and caution. For this reason, the Seller is not able to guarantee the result of any procedure contained herein. Nor can they assume responsibility for any damage to property or injury to persons occasioned from the procedures. Persons engaging the procedures do so entirely at their own risk.

Contains FCC ID: 2ADHKWINC3400

1. This device complies with Part 15 of the FCC rules. Operation is subject to the following two conditions:
 - (1) This device may not cause harmful interference.
 - (2) This device must accept any interference received, including interference that may cause undesired operation.
2. Changes or modifications not expressly approved by the party responsible for compliance could void the user's authority to operate the equipment.

FCC RADIATION EXPOSURE STATEMENT

This equipment complies with FCC RF radiation exposure limits set forth for an uncontrolled environment. This transmitter must not be co-located or operated in conjunction with any other antenna or transmitter. This equipment must be installed and operated with a minimum distance of 20 cm between the radiator and user body.

PROPER DISPOSAL

When this device reaches the end of its useful life, it must be properly disposed of. It must not be disposed of as unsorted municipal waste. Within the European Union, this device should be returned to the distributor from where it was purchased for proper disposal. This is in accordance with EU Directive 2002/96/EC. Within North America, the device should be disposed of in accordance with the local laws regarding the disposal of waste electrical and electronic equipment.

It is everyone's responsibility to help maintain the environment and to reduce the effects of hazardous substances contained in electrical and electronic equipment on human health. Please do your part by making certain that this device is properly disposed of. The symbol shown to the right indicates that this device must not be disposed of in unsorted municipal waste programs.



CAUTION



CAUTION: RISK OF EXPLOSION IF BATTERY IS REPLACED BY AN INCORRECT TYPE. DISPOSE OF USED BATTERIES ACCORDING TO THE INSTRUCTIONS.

ATTENTION: RISQUE D'EXPLOSION SI LA BATTERIES EST REMPLAC'E PAR UN TYPE INCORRECT. REJETEZ LES BATTERIES UTILISE'ES SELON LES INSTRUCTIONS.

| |
|--|
| Serial Number _____ |
| Date of Purchase _____ |
| Purchased From _____ |
| _____ |
| _____ |
| _____ |
| RETAIN THIS INFORMATION FOR FUTURE USE |

| | |
|--|--------------------|
| PRECAUTIONS | |
| Before using this scale, read this manual and pay special attention to all "NOTIFICATION" symbols: | |
| | |
| IMPORTANT | ELECTRICAL WARNING |

TABLE OF CONTENTS

| | |
|--|---------|
| SPECIFICATIONS | Page 1 |
| SITE PREPARATION REQUIREMENTS | Page 3 |
| AC POWER CONNECTION | Page 4 |
| WEIGHING UNITS/HEIGHT MEASUREMENT SELECTION | Page 5 |
| KEYPAD FUNCTIONS | Page 6 |
| ANNUNCIATORS | Page 8 |
| DIALYSIS OPERATION | Page 9 |
| DIALYSIS OPERATION WITH PATIENT ID | Page 12 |
| SCALE SETUP | Page 15 |
| CALIBRATE SCALE | Page 25 |
| LOAD CELL TRIM | Page 38 |
| WI-FI AND BLUETOOTH 5.0 | Page 41 |
| Wi-Fi Features | Page 41 |
| WI-FI SETUP | Page 41 |
| Enable and Configure Wi-Fi Networking | Page 41 |
| Configure Wi-Fi Network Module | Page 44 |
| Changing the Network Credentials | Page 46 |
| Display Wi-Fi Network Settings | Page 46 |
| WI-FI OPERATION | Page 47 |
| Web Server | Page 47 |
| TCP/IP Connection | Page 48 |
| SMA Commands | Page 48 |
| BLUETOOTH LOW ENERGY (BLE) | Page 49 |
| Features Available via BLE | Page 49 |
| Enable Bluetooth (BLE) Networking | Page 49 |
| Bluetooth Pairing | Page 51 |
| INTERFACING TO BLE | Page 52 |
| Standard Services per Bluetooth SIG | Page 52 |
| Device Information Service (0x180A) | Page 52 |
| Battery Service (0x180F) | Page 52 |
| Weight Scale Service (0x181D) | Page 52 |
| BLUETOOTH INTERFACE STANDARD PROTOCOLS | Page 53 |
| Bluetooth Characteristic – Weight_Measurement: 0x2A9D | Page 53 |
| Weight_Measurement: 0x2A9D | Page 53 |
| Custom Services | Page 54 |
| Detecto SMA Service (0x907a0000-8699-47dd-ab30-d7aad5f83e54) | Page 54 |
| SMA Commands | Page 54 |
| WI-FI AND BLUETOOTH SMA COMMANDS | Page 55 |
| DISPLAY SCALE WI-FI AND BLUETOOTH SETTINGS | Page 57 |
| ERROR AND OPERATION MESSAGES | Page 58 |
| BEFORE YOU CALL SERVICE | Page 58 |
| CHANGING THE PAPER ROLL AND RIBBON CARTRIDGE | Page 59 |
| CARE AND CLEANING | Page 60 |
| STATEMENT OF LIMITED WARRANTY | Page 61 |

SPECIFICATIONS

| Specification | Description |
|---------------------------|--|
| Capacity: | 1,000 lb x 0.2 lb / 450 kg x 0.1 kg |
| Weighing/Height Units: | Pounds/Inch (lb, in) or Kilograms/Centimeters (kg, cm) |
| Platform Sizes: | Standard sizes include: 36 x 36 in / 91 x 91 cm, 48 x 36 in / 122 x 91 cm, 48 x 48 in / 122 x 122 cm, and 72 x 48 in / 183 x 122 cm (Custom sizes and configurations are available) |
| Platform Construction: | Anti-corrosion stainless steel |
| Indicator/Printer: | Recessed-mount, touchscreen model 855 indicator/thermal ticket printer combo with stainless steel cover plate |
| Display Type: | 3.2 in (diagonal) full color TFT display 320x240 resolution |
| Number of Characters: | Weight: 5 digits, 0.8 in (20 mm) high Height: 4 digits, 0.35 in (9 mm) high BMI: 3 digits, 0.35 in (9 mm) high |
| Touch Screen: | Resistive touch panel covering the display |
| Keys: | Mechanical switch type, Power, Zero, Lock/Release, ID, Cycle Display Mode, Menu, Print |
| Power Requirements: | 100 to 240 VAC 50/60Hz, 15W |
| Operating Environment: | Operating Temperature Range: 14 to 104 °F (-10 to +40 °C) Humidity: 0 to 90% non-condensing |
| Communication Interfaces: | RS232, USB, Wi-Fi, and Bluetooth 5.0 |
| Includes: | In-floor scales include Model 855RMP digital weight indicator/printer combo, 100 to 240V AC universal switching power supply, interface cable from scale to indicator, pit frame, scale, stainless steel deck, and trim ring |
| Handrail: | Models with H nomenclature (e.g. ID-4848SH-855RMP) include Wraparound tubular handrail with padded handgrip |
| Country of Origin: | USA |
| Approvals: | OIML |

Standard Features:

- Units Locking into LB or KG
- Auto Weight Lock Feature
- 8-Digit Numeric Patient ID
- StableSENSE^{®1} Adjustable Filtering
- Wi-Fi and Bluetooth 5.0

¹ StableSENSE[®] is a digital filter utilizing proprietary software algorithms to remove or greatly reduce changes in the weight display resulting from movement on the scale platform. StableSENSE[®] can be used with clinical scales to lessen the effects of the patient's movement or vibration on the scale. Any application affected by vibration or movement on the scale platform can benefit using StableSENSE[®].

SITE PREPARATION REQUIREMENTS

The Solace In-Floor Dialysis Scale is a precision weight indicating instrument. As with any precision instrument, it requires an acceptable environment to operate at peak performance and reliability. This section is provided to assist you in obtaining such an environment.

Environmental

- For indoor use only.
- Suitable for dry environments only RH < 90% and non-condensing environments.
- NEVER allow the scale to get wet.
- The scale meets or exceeds all certification requirements within a temperature range of 14 to 104 °F (-10 to +40 °C).

The scale should be placed out of direct sunlight and to provide adequate air circulation, keep the area around the scale clear.

Do not place the scale directly in front of a heating or cooling vent. Such a location will subject it to sudden temperature changes, which may result in unstable weight readings.

Ensure that the scale has good, clean AC power and is properly grounded. In areas subject to lightning strikes, additional protection to minimize lightning damage, such as surge suppressors, should be installed.

Electrical Power

The Solace In-Floor Dialysis Scale has been designed to operate from 100 to 240V AC 50/60Hz using a universal switching power supply.

- The customer must supply a conduit connector and wire from the power source to connect to the power supply cable using supplied wire nuts. Refer to the illustration on the next page.
- The conduit connector and wiring should conform to national and local electrical codes and ordinances and should be approved by the local inspector to assure compliance.
- Permanently connected equipment must have a readily accessible disconnect device incorporated in the fixed wiring, such as a circuit breaker.

Electrical Noise Interference

To prevent electrical noise interference, make certain all air conditioning and heating equipment, lighting, or other equipment with heavily inductive loads, such as welders, motors, and solenoids are on circuits separate from the system. Many of these disturbances can seriously affect the operation of the system. These sources of disturbances must be identified and steps must be taken to prevent possible adverse effects on the system. Examples of available alternatives include isolation transformers, power regulators, uninterruptible power supplies, or simple line filters.

AC POWER CONNECTION

The Solace In-Floor Dialysis Scale has been designed to operate from a connection to a permanent power source and contains an internal power supply that can be easily connected to 100 to 240 VAC 50/60Hz.

1. Referring to the figure below, remove the conduit knockout from the enclosure, and replace it with a conduit connector per local Electrical Code.
2. Trim the jacket back 2-inches from the end of the power supply cable, and strip the insulation back from the three individual wires approximately 3/8 inch.
3. Run AC Hot, Neutral, and Ground wires through the conduit into the box area. Trim and strip these as required to connect with the power supply cable.
4. Using supplied wire nuts connect the 3-wires from the AC power source to the 3-wires from the power supply.
5. Remember that the Black wire connects to Brown, and a White wire connects to Blue.

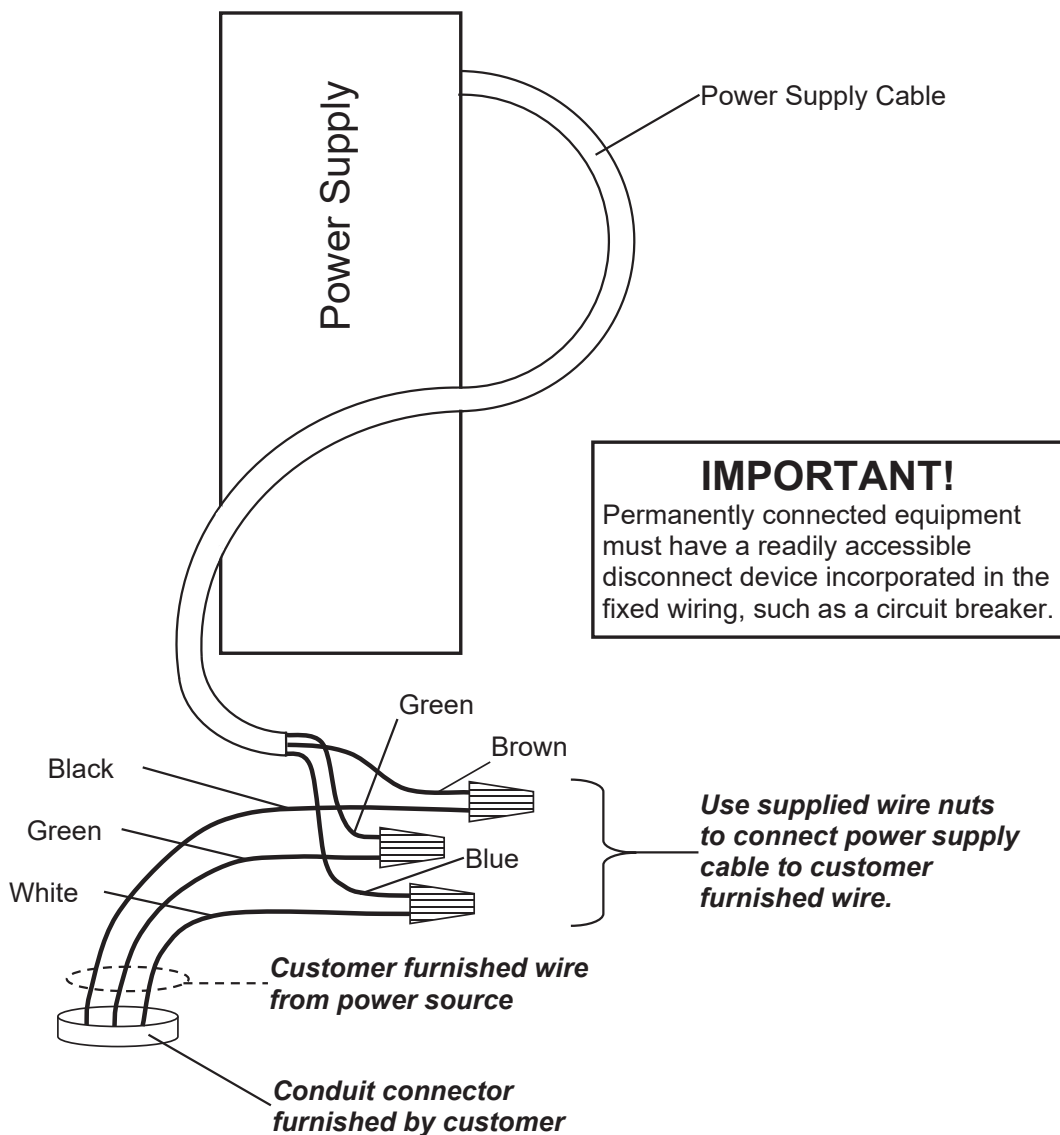

WEIGHING UNITS/HEIGHT MEASUREMENT SELECTION

When the scale is turned on for the *first* time, it will display a prompt to select the weighing units/height measurement to use for your operation, LB/IN (pounds/inches), or KG/CM (kilograms/centimeters). The weighing units/height measurement selection can **ONLY** be made at this time and cannot be changed afterward. Make sure you select the correct weighing units/height measurements before proceeding.



WARNING!

Make sure you select the correct weighing units/height measurement. Once selected the weighing units/height measurement is permanent and cannot be changed.



1. Press  the key to turn the scale on.
2. The scale display will show the software version for a few seconds, the Detecto logo briefly, and then change to a WARNING screen. This screen is displayed to inform and warn you that once you have made the weighing units/height measurement selection, it is PERMANENT and cannot be changed.



3. After reading and understanding the warning screen, press **OK** on the screen to continue.

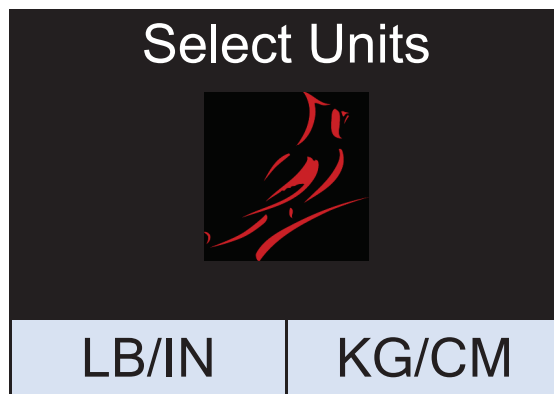

4. If weighing in pounds (LB) and measuring in inches (IN) is required for your operation, press the **LB/IN** key at the bottom left of the screen.
5. If your operation requires weighing in kilograms (KG) and measuring in centimeters (cm), press the **KG/CM** key on the bottom right of the screen.
6. Your Solace In-Floor Dialysis Scale is now ready for operation.

KEYPAD FUNCTIONS

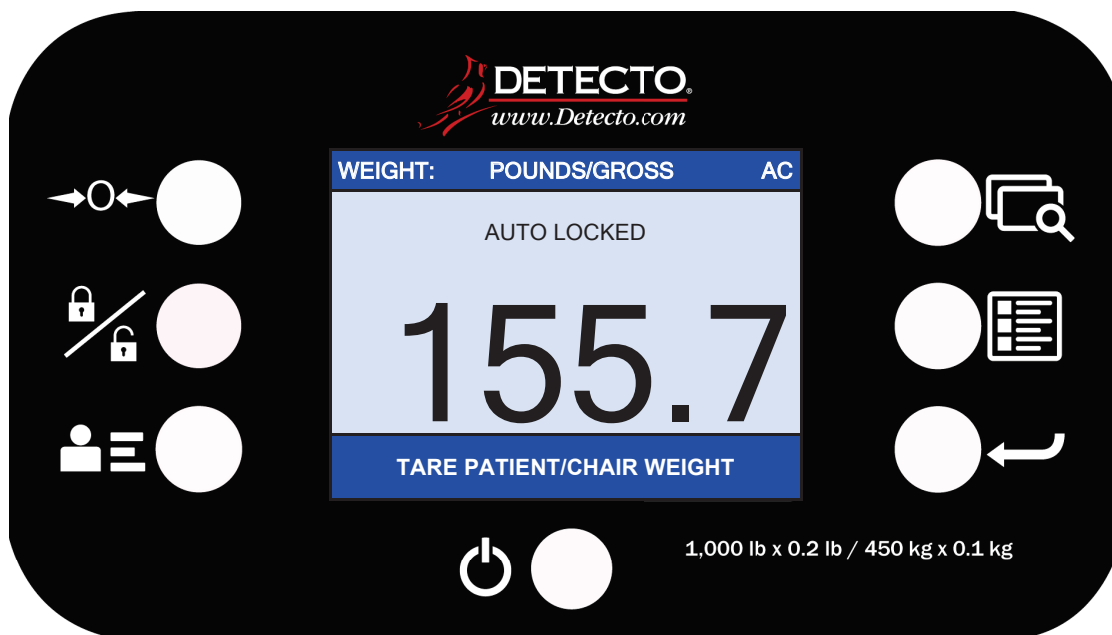

855RM Keypad (without Printer)

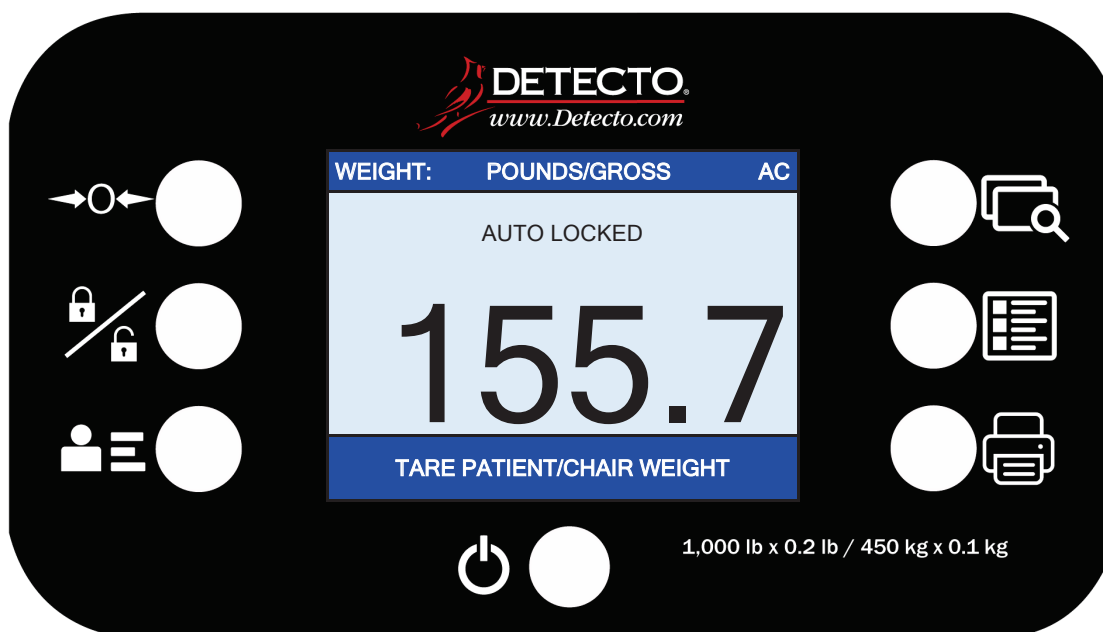

855RMP Keypad (with Printer)



DO NOT operate the keys or touchscreen with pointed objects (pencils, pens, etc.). Damage to keys or touchscreen resulting from this practice is **NOT** covered under warranty.



This is the **Power** key. With the scale off, pressing this key will apply power to the scale and turn on the display. If the scale is already on, pressing the key will turn it off.

KEYPAD FUNCTIONS, CONT.



This is the **Zero** key. Press and release this key to reset the display to zero.

Note that when this key is pressed with weight on the scale platform, the display will zero the weight up to 100% of the scale capacity, and the display will change to zero (0.0). When the weight is removed, the display will show a negative weight. Press the $\Rightarrow 0 \Leftarrow$ key again to reset the display to zero (0.0).



This is the **Lock/Release** key. Press and release this key, or touch the weight readout on the display to cause the weight, height, and BMI to lock on the current values until the key is pressed again or the weight readout on the display is touched again. While the weight is locked, the weight status will change to LOCKED to denote that the weight is being held.



This is the **ID** key. Press and release this key to open the ID entry screen where you can use the touch screen to enter a numeric ID. This ID is NOT used for tracking patient measurements. The ID that is entered is only transmitted out of the communication port when the \leftarrow key is pressed. To change or edit the ID, simply press the **ID** key again to return to the ID entry screen.



This is the **Display Mode** key. Press and release this key to cause the display to cycle between display modes: Weight/Height/BMI or Weight only.



This is the **Menu** key. Press and release this key to launch the Menu screen. The first screen that is displayed is the Setup Review screen where you can see all of the settings at a glance. To continue into setup, touch the Setup key at the bottom right of the touch screen.



This is the **Enter** key. Press and release this key to signal completion of the entry of data and cause the indicator to output the current weight, height, and BMI for data capture for EMR/EHR purposes. The options include Cardinal SMA, Welch Allyn, Tanita, or IEEE 11073-10415 formats.

855RMP ONLY



This is the **Print** key. Press and release this key to cause the indicator to output the current patient information (ID and Gross, Tare, and Net Weight) to the printer for record-keeping.

ANNUNCIATORS

The annunciators are displayed on the Weight screen to show that the indicator is in the mode corresponding to the annunciator label or that the status indicated by the label is active.

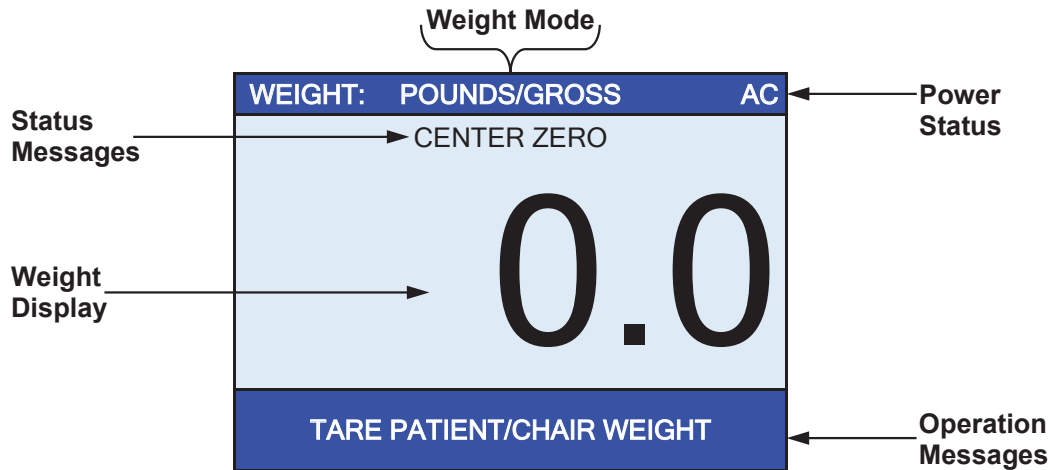

AC

This is shown on the Weight screen to indicate that the indicator is powered by standard 120V AC power.

POUNDS/GROSS

This is shown on the Weight screen to indicate that the weight displayed is gross weight in pounds.



KILOGRAMS/GROSS

This is shown on the Weight screen to indicate that the weight displayed is gross weight in kilograms.

CENTER ZERO

This is shown on the Weight screen to indicate that the weight is within +/- 1/4 division of the center of zero.

LOCK

This is shown on the Weight screen to indicate that the indicator is locked onto the displayed weight. In operation after obtaining a stable weight value, pressing the  key will cause the indicator to lock onto the weight and turn on the annunciator. Pressing the  key a second time will unlock the display and turn off the annunciator.

DIALYSIS OPERATION



ALWAYS assist the patient on and off the scale to ensure they do not fall. **NEVER** leave a patient unattended while they are on the scale. Failure to maintain control of the patient at all times can result in serious injury to the patient and/or you.

Zero Weight Display

1. Press the  key to turn the scale on.
2. In Gross Weight mode (POUNDS/GROSS or KILOGRAMS/GROSS shown on weight screen), if the scale is not showing zero weight on the weight screen press the $\Rightarrow 0 \Leftarrow$ key.
3. The weight screen will return to zero (0.0) and CENTER ZERO will be displayed to show that the scale is ready for use.

Zero Weight Display with Item on Scale

1. Press the  key to turn the scale on.
2. Place the item (wheelchair, Dialysis chair, etc.) on the scale.
3. The display will show the weight of the item on the scale.
4. Press the $\Rightarrow 0 \Leftarrow$ key.
5. The weight screen will return to zero (0.0) and CENTER ZERO will be displayed to show that the weight of the item has been "zeroed off" and the scale is ready to use.

Operation

1. Press the  key to turn the scale on.
2. If required, press the $\Rightarrow 0 \Leftarrow$ key to zero weight screen (with or without item on the scale).
3. Assist the patient onto the scale

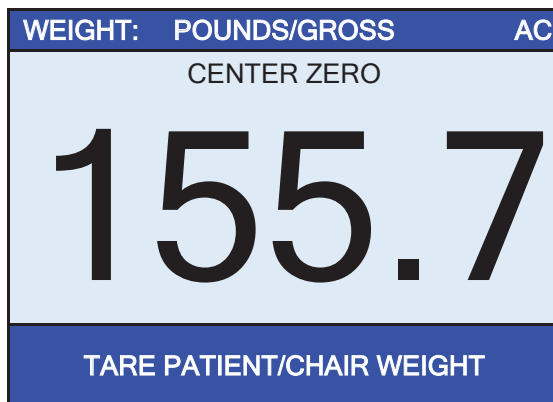

4. When the weight is stable, a beep will sound, weight reading will automatically lock and AUTO LOCK will be displayed. Note that the amount of time the reading will hold is dependent upon the Auto Locking setting in Setup.

NOTE: If more time is needed, press the  key to hold the locked weight reading.

DIALYSIS OPERATION, CONT.

5. Press **TARE PATIENT/CHAIR WEIGHT** on the touchscreen.
6. The display will change to show the **TARGET FLUID REMOVAL** screen.

| TARGET FLUID REMOVAL | | | | |
|--|--------|---|---|-----|
| <div style="font-size: 2em; font-weight: bold; margin-bottom: 5px;">5</div> Key in the numeric target fluid to be removed. | 1 | 2 | 3 | |
| | 4 | 5 | 6 | |
| | 7 | 8 | 9 | |
| SAVE | CANCEL | 0 | . | DEL |

7. Using the numeric keys, enter the amount of fluid to be removed from the patient, and then press the **Save** key.
8. The display will change to a weight monitoring screen with a green background and white numbers for the weight.

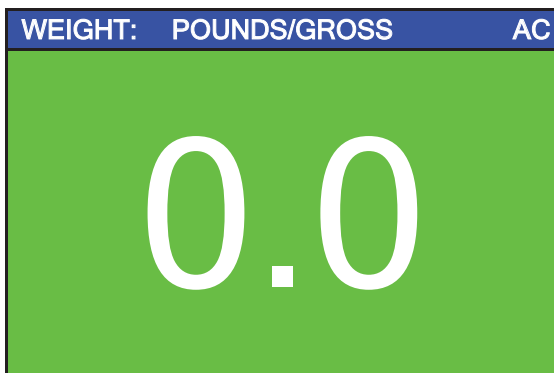

9. As the fluid is being removed from the patient, the scale will display the weight of the fluid.

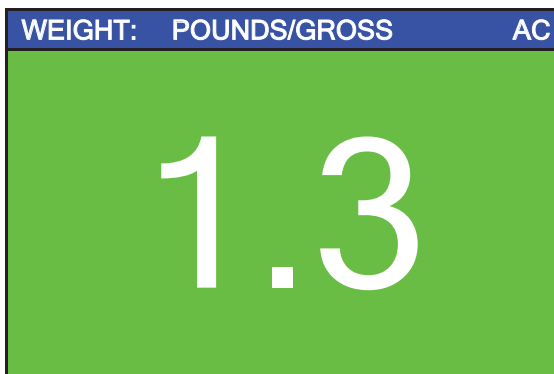

10. Note that while the amount of fluid removed from the patient is less than the **TARGET FLUID REMOVAL** weight value, the background of the display will remain green.

DIALYSIS OPERATION, CONT.

11. Once the amount of fluid removed from the patient is equal to or greater than the TARGET FLUID REMOVAL weight value, the background of the display will change to red, and an alarm (a beeping sound) will turn on.

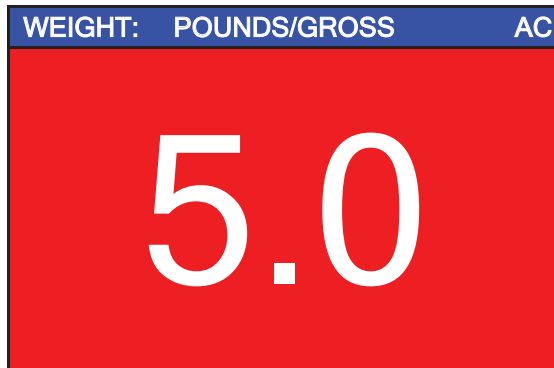

12. When the display changes to red and the alarm (beeping sound) turns on, the operator can touch anywhere on the display to end the Dialysis process. The display will change to the **Results** screen with details of the Dialysis process shown.

| Results | |
|---------|-----------|
| Date: | 2/24/2020 |
| | |
| Target: | 5 |
| Actual: | 5.0 |
| Exit | Print |

13. With the **Results** screen displayed, the operator can press **Print**, to print a ticket with the details of the Dialysis process, or press **Exit** to return to the main screen.
14. Assist the patient off the scale.

DIALYSIS OPERATION WITH PATIENT ID



ALWAYS assist the patient on and off the scale to ensure they do not fall. **NEVER** leave a patient unattended while they are on the scale. Failure to maintain control of the patient at all times can result in serious injury to the patient and/or you.

Zero Weight Display

1. Press the key to turn the scale on.
2. In Gross Weight mode (POUNDS/GROSS or KILOGRAMS/GROSS shown on weight screen), if the scale is not showing zero weight on the weight screen press the $\Rightarrow 0 \Leftarrow$ key.
3. The weight screen will return to zero (0.0) and CENTER ZERO will be displayed to show that the scale is ready to use.

Zero Weight Display with Item on Scale

1. Press the key to turn the scale on.
2. Place the item (wheelchair, Dialysis chair, etc.) on the scale.
3. The display will show the weight of the item on the scale.
4. Press the $\Rightarrow 0 \Leftarrow$ key.
5. The weight screen will return to zero (0.0) and CENTER ZERO will be displayed to show that the weight of the item has been "zeroed off" and the scale is ready to use.

Operation with a Patient ID

1. Press the key to turn the indicator on.
2. If required, press the $\Rightarrow 0 \Leftarrow$ key to zero weight screen (with or without item on the scale).
3. Press the key.
4. The display will change to show the PATIENT ID screen.

| PATIENT ID | | | | |
|--|--------|---|---|-----|
| 12345678 | | 1 | 2 | 3 |
| Key in the numeric patient ID to be transmitted when the Print key is pressed. | | 4 | 5 | 6 |
| | | 7 | 8 | 9 |
| | | 0 | . | DEL |
| SAVE | CANCEL | | | |

5. Using the numeric keys, enter up to an 8-digit numeric identification number for the patient, and then press the **Save** key.
6. Assist the patient on the scale
7. When weight is stable, a beep will sound, weight reading will automatically lock and AUTO LOCK will be displayed. Note that the amount of time the reading will hold is dependent upon the Auto Locking setting in Setup.

NOTE: If more time is needed, press the key to hold the locked weight reading.

DIALYSIS OPERATION WITH PATIENT ID, CONT.

- Press **TARE PATIENT/CHAIR WEIGHT** on the touchscreen.
- The display will change to show the **TARGET FLUID REMOVAL** screen.

| TARGET FLUID REMOVAL | | | | |
|---|--------|---|---|-----|
| 5 Key in the numeric target fluid to be removed. | 1 | 2 | 3 | |
| | 4 | 5 | 6 | |
| | 7 | 8 | 9 | |
| SAVE | CANCEL | 0 | . | DEL |

- Using the numeric keys, enter the amount of fluid to be removed from the patient, and then press the **Save** key.
- The display will change to a weight monitoring screen with a green background and white numbers for the weight.

| WEIGHT: | POUNDS/GROSS | AC |
|---------|--------------|----|
| 0.0 | | |

- As the fluid is being removed from the patient, the scale will display the weight of the fluid.

| WEIGHT: | POUNDS/GROSS | AC |
|---------|--------------|----|
| 1.3 | | |

- Note that while the amount of fluid removed from the patient is less than the **TARGET FLUID REMOVAL** weight value, the background of the display will remain green.

DIALYSIS OPERATION WITH PATIENT ID, CONT.

14. Once the amount of fluid removed from the patient is equal to or greater than the TARGET FLUID REMOVAL weight value, the background of the display will change to red, and an alarm (a beeping sound) will turn on.

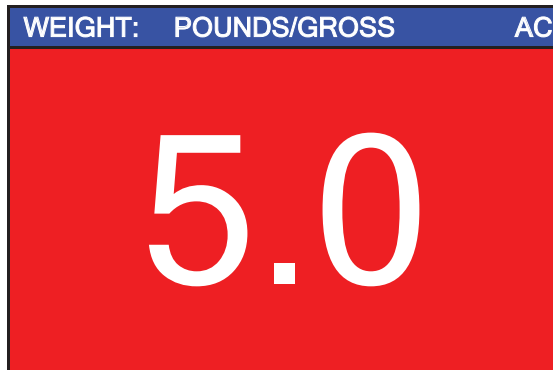

15. When the display changes to red and the alarm (beeping sound) turns on, the operator can touch anywhere on the display to end the Dialysis process. The display will change to a **Results** screen with details of the Dialysis process shown.

| Results | |
|---------|-----------|
| Date: | 2/24/2020 |
| | |
| Target: | 5 |
| Actual: | 5.0 |
| Exit | Print |

16. With the **Results** screen displayed, the operator can press **Print**, to print a ticket with the details of the Dialysis process, or press **Exit** to return to the main screen.
17. Assist the patient off the scale.

SCALE SETUP

Your Solace In-Floor Dialysis Scale has been pre-configured at the factory and should not require changes for use in most applications. However, if the factory settings do not meet the requirements of your operation, the following describes the setup process for your indicator.



NOTE: The keypad and touchscreen are not to be operated with pointed objects (pencils, pens, fingernails, etc.). Damage to the keypad or touchscreen resulting from this practice will NOT be covered under warranty.

Menu Functions

After pressing the **Menu** key to enter the Setup menu, the first screen of the menu is a Setup Review screen where all of the settings can be reviewed at a glance. The Audit Trail Counters for the metrological settings and the non-metrological settings are available for review on this screen as well. Each prompt in the menu screens will show the current value of the setting next to the prompt to easily identify what the current setting for that parameter is.

Setup Menu Keys

- The Sonar Height Rod is not used with the Solace In-Floor Dialysis Scale and should be disabled. To ensure the sonar height is disabled, press the **Sonar** key, the **0** key, and then press the **Save** key. The sonar height rod is now disabled, and the display will change back to the Settings Overview 1 screen.
- Press the **Exit** key to exit Setup and return to the Weight screen.
- Press the **Setup** key on the Settings Overview screen to enter into the scale setup.
- Press the **>>>** key on the bottom right of the Settings screen to advance to the next menu page.
- Press the **<<<** key at the bottom left of the Settings screen to return to the previous menu page.

To Enter Setup

1. Press the  key to turn the indicator on.
2. The indicator will show the Detecto logo briefly and then change to the Weight screen.
3. With the Weight screen displayed, press the **Menu** key.
4. The display will change to show the Settings Overview 1 screen.

| SETTINGS OVERVIEW 1 | | >>> |
|---|------------------|--------------|
| Revision 1.00.09, Display Rev. 1.0.18 | | |
| Audit Trail -- Cal=4, Cfg=2 | | |
| Range 1: 600.0 x 0.2 -- 2: 1000.0 x 0.5 | | |
| Weight Units=lb | Height Units=in | |
| Auto Lock=5 s | Sonar Ht=0.0 cm | |
| Motion=3 div. | Filter=Off | |
| OIML=No | ZeroTrack=10/2 d | |
| USB: SMA | Gravity=0.000000 | |
| Power up zero=No | | |
| Sonar | Exit | Setup |

- Press **>>>** on top right of touchscreen to advance to the Settings Overview 2 screen.
- Press the **Exit** key to exit Setup and return to the Weight screen.
- Press the **Setup** key to advance to the Password screen and proceed with scale setup.

To Enter Setup, Cont.

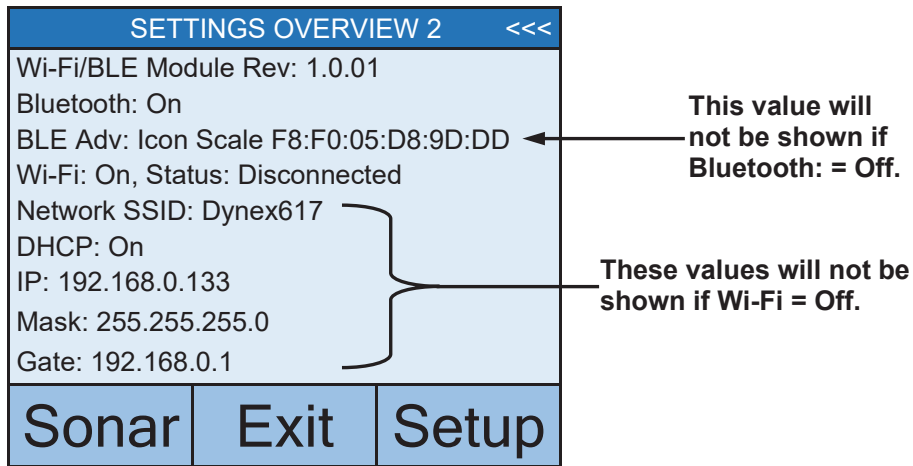

- Press <<< on top right of touchscreen to return to the Settings Overview 1 screen.
 - Press the **Exit** key to exit Setup and return to the Weight screen.
 - Press the **Setup** key to advance to the Password screen and proceed with scale setup.
5. After pressing **Setup** on the touchscreen, the display will change to show the ENTER PASSCODE screen.

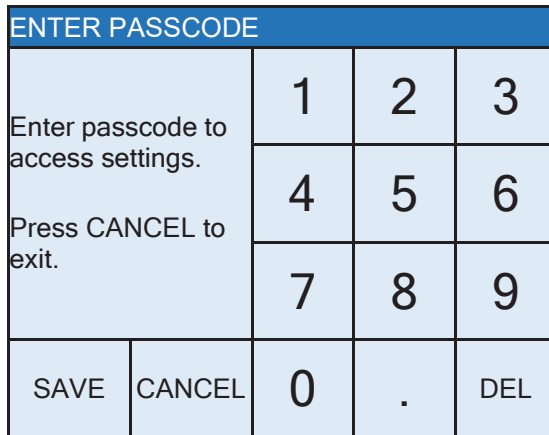

6. Using the 10-key on the touchscreen, enter 64870 and then press the **Save** key.
7. The scale is now ready for setup and calibration

Settings Page 1

| | | |
|-------------------|------|--------|
| SETTINGS | | PAGE 1 |
| Model: Dialysis | | |
| Date: 2/24/2020 | | |
| Time: 12:24:44 | | |
| Language: English | | |
| <<< | Exit | >>> |

Model:

This will change the default settings and operation of the scale. For example, selecting “Dialysis” as the model changes the scale to use the software specially designed for dialysis patient care.

Touch this key to open the model selection screen. Using the numeric keys, enter a new setting, and then press the Save key.

Allowable settings are: 0 = icon, 1 = Wheelchair, 2 = Other, 3 = Dialysis

Date:

Touching this key allows entering the date, starting with the year. After pressing **Date:** the screen will show “Key in the Year and press SAVE”.

Year

Enter the 4-digits (YYYY) for the year and then press the **Save** key.

Month

Enter the 2-digits (MM) for the month and then press the **Save** key.

Day

Enter the 2-digits (DD) for the day and then press the **Save** key.

Time:

Touching this key allows entering the time starting with the hour. After pressing **Time:** the screen will show “Key in the Hour HH”.

Hour

Enter the 2-digits (HH) for the hour and then press the **Save** key.

Minute

Enter the 2-digits (MM) for the minute and then press the **Save** key.

Second

Enter the 2-digits (SS) for the seconds and then press the **Save** key.

Language:

This will change the language for the Setup and Operation screens of the scale.

Touch this key to open the language selection screen. Using the numeric keys, enter a new setting, and then press the **Save** key.

Allowable settings are: 0 = English, 1 = Spanish, 2 = German, 3 = French

- Press the >>> key to advance to the Settings Page 2.
- Press the <<< key to return to the Settings Overview screen.
- Press the **Exit** key to exit Setup and return to the Weight screen.

Settings Page 2

| SETTINGS | | PAGE 2 |
|-------------------|------|--------|
| OIML: No | | |
| Units: lb, in | | |
| Filter Mode: 0 | | |
| Zero Tracking: 10 | | |
| <<< | Exit | >>> |

OIML:

Touching this key will toggle the OIML setting to Yes or No. **NOTE:** This setting should be enabled for all EU models to comply with regulations.

Allowable settings for OIML are: Yes or No.

Units:

This is for reference only. The weighing/height units selection can **ONLY** be made when the scale is turned on for the *first* time. At that time, a prompt will be displayed to select the weighing/height units to use, pounds/inches (lb/in), or kilograms/centimeters (kg/cm). Once the weighing/height units have been set, it cannot be changed.

Refer to the WEIGHING UNITS/HEIGHT MEASUREMENT section of this manual.

Filter Mode:

Pressing this key will open the weight filtering screen. This will allow you to set the amount of digital filtering being applied to the scale. Using the numeric keys, enter a new setting, and then press the **Save** key.

Allowable settings are: 0 = Off, 1 = Minimal, 2 = Moderate, and 3 = Maximum

Zero Tracking:

Touching this key will open the zero-tracking screen. This will allow you to set the number of half (1/2) divisions that the scale will attempt to maintain zero. Using the numeric keys, enter a new setting, and then press the **Save** key.

Allowable settings for Zero Tracking are 0 – 20.

- Press the >>> key to advance to the Settings Page 3.
- Press the <<< key to return to the Settings Page 1.
- Press the **Exit** key to exit Setup and return to the Weight screen.

Settings Page 3

| SETTINGS | | PAGE 3 |
|--------------------|------|--------|
| Capacity 1: 600.0 | | |
| Capacity 2: 1000.0 | | |
| Interval 1: 2 | | |
| Interval 2: 5 | | |
| <<< | Exit | >>> |

Capacity 1:

Touching this key will open the capacity screen. This will allow you to set the capacity of the first range. Using the numeric keys, enter a new setting, and then press the **Save** key.

The first range of the scale should be set to 600.0.

Capacity 2:

Touching this key will open the capacity entry screen for the second weight range. This setting **MUST** be greater than Capacity 1 if used. Using the numeric keys, enter a new setting, and then press the **Save** key.

The second range of the scale should be set to 1000.0.

NOTE: To disable the second weight range, set Capacity 2 to a setting of (0) zero.

Interval 1:

Touching this key will open the interval entry screen. This will allow you to set the scale interval for the first range. Using the numeric keys, enter a new setting, and then press the **Save** key.

Allowable settings for Interval 1 are 1, 2, or 5.

Interval 2:

If a second range capacity has been set, then Interval 2 will be used as the interval of the second weight range if enabled (see Capacity2). Using the numeric keys, enter a new setting, and then press the **Save** key.

Allowable settings for Interval 2 are 1, 2, or 5.

- Press the >>> key to advance to Settings Page 4.
- Press the <<< key to return to Settings Page 2.
- Press the **Exit** key to exit Setup and return to the Weight screen.

Settings Page 4

| SETTINGS | | PAGE 4 |
|-------------------|------|--------|
| Decimal 1: 1 | | |
| Decimal 2: 1 | | |
| Motion Range: 3 | | |
| Gravity: 0.000000 | | |
| <<< | Exit | >>> |

Decimal 1:

Touching this key will open the decimal entry screen. This will allow you to set the decimal point precision for the first weight range. Using the numeric keys, enter a new setting, and then press the **Save** key.

Allowable settings for Decimal 1 are 0 – 3.

Decimal 2:

Touching this key will open the decimal entry screen. This will allow you to set the decimal point precision for the second weight range if enabled (see Capacity2). Using the numeric keys, enter a new setting, and then press the **Save** key.

Allowable settings for Decimal 2 are 0 – 3.

Motion Range:

Touching this key will open the motion range entry screen. This will allow you to set the number of scale divisions of movement that will be allowed for a stable weight. Using the numeric keys, enter a new setting, and then press the **Save** key.

Allowable settings for Motion Range are 0 – 20.

Gravity:

Gravity compensation accounts for latitudes and elevations that are different from where the scale was calibrated. To calculate the setting for this parameter, use the gravitational constant of the location where the scale was calibrated divided by the gravitational constant of where the scale will be installed:

$$\frac{\text{Gravitational Constant (Calibration location)}}{\text{Gravitational Constant (Operation location)}} = \text{setting}$$

This should give you a setting close to 1 that you can enter in to compensate for variation in gravity due to elevation/latitude.

Touching this key will open the gravity compensation entry screen. Using the numeric keys, enter a new setting, and then press the **Save** key.

NOTE: If you do not wish to use the compensation feature, it must be set to 0 (zero) to disable it.

- Press the >>> key to advance to the Settings Page 5.
- Press the <<< key to return to the Settings Page 3.
- Press the **Exit** key to exit Setup and return to the Weight screen.

Settings Page 5

| | | |
|-------------------|------|--------|
| SETTINGS | | PAGE 5 |
| Calibrate Scale | | |
| Load Cell Trim | | |
| Power up Zero: No | | |
| Auto Locking: 5 s | | |
| <<< | Exit | >>> |

Calibrate Scale

Touching this key will allow for calibration of the scale. Refer to the **CALIBRATION** section of this manual for instructions to select the calibration mode and how to perform calibration.

Load Cell Trim

Touching this key will allow for trimming (adjusting the output of) the load cells in the scale. Refer to the **LOAD CELL TRIM** section of this manual for instructions on how to trim the load cells.

Auto Locking:

This setting is used by the scale to hold a stable patient weight for a desired amount of time. For example, if a setting of 5 seconds is used, then when the scale locks onto a stable patient weight, it will remain locked for 5 seconds before automatically releasing the weight.

Touching this key will open an entry screen for the auto-locking feature of the scale. The setting entered is a time in seconds. Using the numeric keys, enter a new setting, and then press the **Save** key.

Allowable settings for Auto Locking are 0 to 10.

Power up Zero:

Touching this key will toggle the power up zeroing of the scale to Yes or No. If enabled, this will cause the scale to attempt to zero the scale upon power up.

Allowable settings for Power up Zero are: Yes or No.

- Press the >>> key to advance to the Settings Page 6.
- Press the <<< key to return to the Settings Page 4.
- Press the **Exit** key to exit Setup and return to the Weight screen.

Settings Page 6

| SETTINGS | | PAGE 6 |
|-------------------|------|--------|
| Serial Type: Pass | | |
| USB: SMA | | |
| Print: Manual | | |
| | | |
| <<< | Exit | >>> |

Serial Type:

Touch this key to open the serial type selection screen to change the operation of the Serial RS232 port. Using the numeric keys, enter a new setting, and then press the **Save** key.

Allowable settings are: 0 = pass through printing, 1 = Spot LXi¹

If Spot LXi was selected for Serial Type, the scale will automatically interface to a Welch-Allyn Spot LXi interface device to transmit weight data.

USB:

Touch this key to open the USB port selection screen to change the operation of the USB port. Using the numeric keys, enter a new setting, and then press the **Save** key.

Allowable settings are: 0 = SMA, 1 = Welch Allyn¹, 2 = PHDC

- If SMA was selected, and the scale is connected to a computer for transmission of weight data to a PC-based electronic medical record software program, it will transmit a single set of weight data each time an SMA weight request <LF>W<CR> is received.
- If Welch Allyn was selected, the scale will automatically transmit data to a Welch Allyn CVSM Device as soon as a stable weight is obtained.
- If PHDC (Personal Healthcare Device Class) was selected, the scale will transmit data using the CEN ISO/IEEE 11073 Medical / Health Device Communication Standard.

Print:

Touching this key will toggle the Print setting to Auto or Manual for printing (outputting data) when a stable weight has been obtained on the scale.

- If "Auto" is selected, the scale will automatically print (output data) as soon as a stable weight is obtained.
- If "Manual" is selected, after a stable weight has been obtained, you must press the  key to print (output data).

Allowable settings for Print are: 0 = Manual, 1 = Auto

- Press the >>> key to advance to the Settings Page 7.
- Press the <<< key to return to the Settings Page 5.
- Press the **Exit** key to exit Setup and return to the Weight screen.

¹ Requires device to have an activated license. Must purchase Detecto WACONNECT.

Settings Page 7

| SETTINGS | | PAGE 7 |
|----------------|------|--------|
| Bluetooth: On | | |
| Wi-Fi: Off | | |
| SSID: Dynex617 | | |
| | | |
| <<< | Exit | >>> |

The SSID: value will not be shown if Wi-Fi: = Off.

Bluetooth:

Touch this key to open a selection screen to turn the Bluetooth 5.0 wireless transmitter On or Off. This setting should be On if pairing to a Bluetooth-capable device is desired. Using the numeric keys, enter a new setting, and then press the **Save** key.

Allowable settings for Bluetooth are: 0 = Off, 1 = On

Wi-Fi:

Touch this key to open a selection screen to turn the Wi-Fi wireless transmitter On or Off. This setting should be On if interfacing through a Wi-Fi network is desired. Using the numeric keys, enter a new setting, and then press the **Save** key.

Allowable settings for Wi-Fi are: 0 = Off, 1 = On



NOTE: If the Wi-Fi setting is 0 = Off, you will not see the SSID: setting and the >>> key on the touchscreen to advance to Settings Page 8.

SSID:

This will show you the current SSID of the Wi-Fi network that is saved in memory for the Icon to connect to.

Touching this key will prompt you to CLEAR SSID. Press 1 on the entry screen, and then press the **Save** key to clear the Wi-Fi credentials.

- Press the >>> key to advance to the Settings Page 8.
- Press the <<< key to return to the Settings Page 6.
- Press the **Exit** key to exit Setup and return to the Weight screen.

Settings Page 8

| SETTINGS | | PAGE 8 |
|-------------------|------|--------|
| DHCP: On | | |
| IP: 192.168.0.133 | | |
| NM: 255.255.255.0 | | |
| GW: 192.168.0.1 | | |
| <<< | Exit | |

The settings for NM: and GW: will not be shown if DHCP: = On.

DHCP:

Touching this key will open an entry screen to allow you to select the DHCP setting. This setting selects whether the Wi-Fi wireless transmitter will use a dynamic IP address assigned by a DHCP server or a static IP address. Consult with your network administrator for the proper selection. Using the numeric keys, enter a new setting, and then press the **Save** key.

Allowable settings for DHCP are: 0 = Static IP (Off), 1 = DHCP (On)



NOTE: If the setting for **DHCP: = Off**, the settings for **NM:** (Netmask) and **GW:** (Gateway Address) will be shown on the touchscreen.

NM: (Netmask)

Touching this key will open an entry screen to allow you to enter the Wi-Fi network Netmask for the network the scale will be connected to. Using the numeric keys, enter a new setting, and then press the **Save** key.

The format for the Netmask is: ### . ### . ### . # (e.g., 255.255.255.0).

IMPORTANT! The Netmask of the scale should match the Netmask of the other computers on your network.

GW: (Gateway Address)

Touching this key will open an entry screen to allow you to enter the Wi-Fi network Gateway Address for the network the scale will be connected to. Using the numeric keys, enter a new setting, and then press the **Save** key.

The format for the Gateway Address is: #, #, #, # (e.g., 192.168.0.1).

- Press the <<< key to return to the Settings Page 7.
- Press the **Exit** key to exit Setup and return to the Weight screen.

CALIBRATE SCALE

Calibration Modes

The Solace In-Floor Dialysis Scale has four modes that can be used to perform calibration. The modes are as follows:

1 = SmartCal®

SmartCal is the most precise method of calibration. It requires that a calibrated load be placed over each load cell of the scale platform only once. In this method, the scale will be able to derive calibration constants, which will be used to combine information from each load cell into scale weight.

During SmartCal, the display will prompt for the test load to be applied over a particular load cell. With a scale that has four load cells, the order will simply be cell 1, cell 2, cell 3, and cell 4. This order is used so that calibration can be done using a test weight with a minimal amount of maneuvering required. Refer to the illustration below.

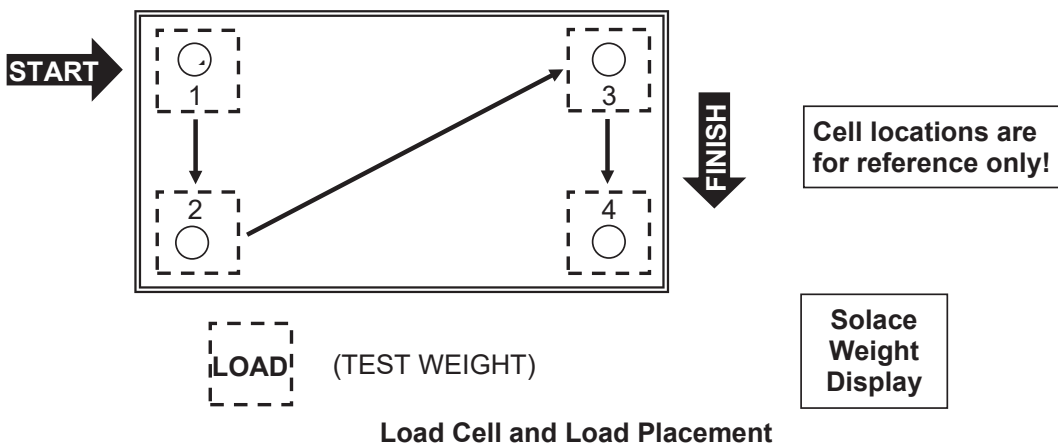

2 = Two Calibration Points

This is a standard calibration method requiring an empty scale and one weight. This method uses two calibration points (an empty scale and the full test load on the scale) to establish a zero (no load) calibration value and to span the indicator.

3 = Three Calibration Points

This method requires an empty scale, two weights, and uses three calibration points, (an empty scale, half the test load, and the full test load on the scale). The three points correspond to zero (no load) weight, mid-point weight, and test load (weight).

4 = Four Calibration Points

This method requires an empty scale, three weights, and uses four calibration points, (an empty scale, one-fourth the test load, half the test load, and the full test load on the scale). The four points correspond to zero weight, quarter-point weight, mid-point weight, and test load (weight).

To Enter Calibration

1. With the scale turned on and the Weight screen displayed, press the **Menu** key.
2. The display will change to show the Settings Overview 1 screen.

| SETTINGS OVERVIEW 1 >>> | | |
|---|------------------|-------|
| Revision 1.00.09, Display Rev. 1.0.18 | | |
| Audit Trail -- Cal=4, Cfg=2 | | |
| Range 1: 600.0 x 0.2 -- 2: 1000.0 x 0.5 | | |
| Weight Units=lb | Height Units=in | |
| Auto Lock=5 s | Sonar Ht=0.0 cm | |
| Motion=3 div. | Filter=Off | |
| OIML=No | ZeroTrack=10/2 d | |
| USB: SMA | Gravity=0.000000 | |
| Power up zero=No | | |
| Sonar | Exit | Setup |

3. Press **Setup** on the touchscreen.
4. The display will change to show the ENTER PASSCODE screen.

| ENTER PASSCODE | | | | |
|---|--------|---|---|-----|
| Enter passcode to access settings. Press CANCEL to exit. | 1 | 2 | 3 | |
| | 4 | 5 | 6 | |
| | 7 | 8 | 9 | |
| SAVE | CANCEL | 0 | . | DEL |

5. Using the 10-key on the touchscreen, enter 64870 and then press the **Save** key.
6. The display will change to show the Settings Page 1 screen.

| SETTINGS | PAGE 1 |
|-------------------|----------|
| Model: Dialysis | |
| Date: 2/24/2020 | |
| Time: 12:24:44 | |
| Language: English | |
| <<< | Exit >>> |

7. Press the >>> key to advance to the Settings Page 5 screen.

To Enter Calibration, Cont.

| | | |
|-------------------|------|--------|
| SETTINGS | | PAGE 5 |
| Calibrate Scale | | |
| Load Cell Trim | | |
| Power up Zero: No | | |
| Auto Locking: 5 s | | |
| <<< | Exit | >>> |

8. Select **Calibrate Scale** from the Settings Page 5 screen.
9. The display will change to show the “Number of Points” screen.

| | | | | |
|---|--------|---|---|-----|
| CALIBRATE SCALE | | | | |
| 2 Number of points at which the scale will be calibrated. 1 = SmartCal | 1 | 2 | 3 | |
| | 4 | 5 | 6 | |
| | 7 | 8 | 9 | |
| SAVE | CANCEL | 0 | . | DEL |

10. With the “Number of Points” screen displayed, select 1, 2, 3, or 4 on the touchscreen and then press the **Save** key.

1 = SmartCal Calibration

(calibrated load placed over each load cell only once)

2 = Two Calibration Points

(empty scale and full test load)

3 = Three Calibration Points

(empty scale, half test load, and full test load)

4 = Four Calibration Points

(empty scale, one fourth test load, half test load, and full test load)

11. Proceed to the next sections of the manual for the type of calibration selected.

1 = SmartCal®

1. With the “Number of Points” screen displayed, press the 1 key on the touchscreen and then press the **Save** key.

| CALIBRATE SCALE | | | | |
|---|--------|---|---|-----|
| 1 Number of points at which the scale will be calibrated. 1 = SmartCal | | 1 | 2 | 3 |
| | | 4 | 5 | 6 |
| | | 7 | 8 | 9 |
| SAVE | CANCEL | 0 | . | DEL |

2. The display will change to show “Enter the known test weight”. Enter the value for the test weight and then press the **Save** key.

| CALIBRATE SCALE | | | | |
|--------------------------------------|--------|---|---|-----|
| 0 Enter the known test weight. | | 1 | 2 | 3 |
| | | 4 | 5 | 6 |
| | | 7 | 8 | 9 |
| SAVE | CANCEL | 0 | . | DEL |

3. The display will change to show “To calibrate zero, remove any weight from the scale before proceeding”. Make certain the scale is empty and then press the **Save** key.

| CALIBRATE SCALE | | | | |
|---|--------|---|---|-----|
| 0 To calibrate zero, remove any weight from the scale before proceeding | | 1 | 2 | 3 |
| | | 4 | 5 | 6 |
| | | 7 | 8 | 9 |
| SAVE | CANCEL | 0 | . | DEL |

1 = SmartCal, Cont.

- The display will change to show “Working” for a few seconds and then change to show “Set test weight over Cell 1”.

| CALIBRATE SCALE | | | | |
|--|--------|---|---|-----|
| Working To calibrate zero, remove any weight from the scale before proceeding | | 1 | 2 | 3 |
| | | 4 | 5 | 6 |
| | | 7 | 8 | 9 |
| SAVE | CANCEL | 0 | . | DEL |

- Place the calibrated test weight on the scale over Cell 1 and then press the **Save** key.

| CALIBRATE SCALE | | | | |
|---|--------|---|---|-----|
| Set test weight over Cell 1 and press Save. | | 1 | 2 | 3 |
| | | 4 | 5 | 6 |
| | | 7 | 8 | 9 |
| SAVE | CANCEL | 0 | . | DEL |

- The display will change to show “Working” for a few seconds and then change to show “Set test weight over Cell 2”.

| CALIBRATE SCALE | | | | |
|---|--------|---|---|-----|
| Set test weight over Cell 2 and press Save. | | 1 | 2 | 3 |
| | | 4 | 5 | 6 |
| | | 7 | 8 | 9 |
| SAVE | CANCEL | 0 | . | DEL |

- Place the calibrated test weight on the scale over Cell 2 and then press the **Save** key.

1 = SmartCal, Cont.

8. The display will change to show “Working” for a few seconds and then change to show “Set test weight over Cell 3”.

| CALIBRATE SCALE | | | | |
|---|--------|---|---|-----|
| Set test weight over Cell 3 and press Save. | | 1 | 2 | 3 |
| | | 4 | 5 | 6 |
| | | 7 | 8 | 9 |
| SAVE | CANCEL | 0 | . | DEL |

9. Place the calibrated test weight on the scale over Cell 3 and then press the **Save** key.
10. The display will change to show “Working” for a few seconds and then change to show “Set test weight over Cell 4”.

| CALIBRATE SCALE | | | | |
|---|--------|---|---|-----|
| Set test weight over Cell 4 and press Save. | | 1 | 2 | 3 |
| | | 4 | 5 | 6 |
| | | 7 | 8 | 9 |
| SAVE | CANCEL | 0 | . | DEL |

11. Place the calibrated test weight on the scale over Cell 4 and then press the **Save** key.
12. The display will change to show “Working” for a few seconds and then return to the Settings Page 5 screen.
13. Calibration is now complete.
14. Press the **Exit** key to exit Setup and return to the Weight screen.

2 = Two Calibration Points

1. With the “Number of Points” screen displayed, press the 2 key on the touchscreen and then press the **Save** key.

| CALIBRATE SCALE | | | | |
|---|--------|---|---|-----|
| 2 Number of points at which the scale will be calibrated. 1 = SmartCal | 1 | 2 | 3 | |
| | 4 | 5 | 6 | |
| | 7 | 8 | 9 | |
| SAVE | CANCEL | 0 | . | DEL |

2. The display will change to show “To calibrate zero, remove any weight from the scale before proceeding”. Make certain the scale is empty and then press the **Save** key.

| CALIBRATE SCALE | | | | |
|---|--------|---|---|-----|
| 0 To calibrate zero, remove any weight from the scale before proceeding | 1 | 2 | 3 | |
| | 4 | 5 | 6 | |
| | 7 | 8 | 9 | |
| SAVE | CANCEL | 0 | . | DEL |

3. The display will change to show “Working” for a few seconds.

| CALIBRATE SCALE | | | | |
|---|--------|---|---|-----|
| Working To calibrate zero, remove any weight from the scale before proceeding | 1 | 2 | 3 | |
| | 4 | 5 | 6 | |
| | 7 | 8 | 9 | |
| SAVE | CANCEL | 0 | . | DEL |

4. The display will then change to show the “Known test weight” screen.

2 = Two Calibration Points, Cont.

- Place the calibrated test weight (full test load) on the scale, enter the value for the test weight, and then press the **Save** key.

| CALIBRATE SCALE | | | | |
|---|--------|---|---|-----|
| 1000.0 This is the known test weight that is currently on the scale. | | 1 | 2 | 3 |
| | | 4 | 5 | 6 |
| | | 7 | 8 | 9 |
| SAVE | CANCEL | 0 | . | DEL |

NOTE: A minimum of 50% of the scale's capacity is required, however 70% to 100% is recommended.

- The display will change to show "Working" for a few seconds and then return to the Settings Page 5 screen.

| CALIBRATE SCALE | | | | |
|--|--------|---|---|-----|
| Working This is the known test weight that is currently on the scale. | | 1 | 2 | 3 |
| | | 4 | 5 | 6 |
| | | 7 | 8 | 9 |
| SAVE | CANCEL | 0 | . | DEL |

- Calibration is now complete.
- Press the **Exit** key to exit Setup and return to the Weight screen.

3 = Three Calibration Points

1. With the “Number of Points” screen displayed, press the 3 key on the touchscreen and then press the **Save** key.

| CALIBRATE SCALE | | | | |
|--|--------|---|---|-----|
| 3 Number of points at which the scale will be calibrated. 1 = SmartCal | 1 | 2 | 3 | |
| | 4 | 5 | 6 | |
| | 7 | 8 | 9 | |
| SAVE | CANCEL | 0 | . | DEL |

2. The display will change to show “To calibrate zero, remove any weight from the scale before proceeding”. Make certain the scale is empty and then press the **Save** key.

| CALIBRATE SCALE | | | | |
|--|--------|---|---|-----|
| 0 To calibrate zero, remove any weight from the scale before proceeding | 1 | 2 | 3 | |
| | 4 | 5 | 6 | |
| | 7 | 8 | 9 | |
| SAVE | CANCEL | 0 | . | DEL |

3. The display will change to show “Working” and after a few seconds change to show the “Known test weight” screen.

| CALIBRATE SCALE | | | | |
|--|--------|---|---|-----|
| Working To calibrate zero, remove any weight from the scale before proceeding | 1 | 2 | 3 | |
| | 4 | 5 | 6 | |
| | 7 | 8 | 9 | |
| SAVE | CANCEL | 0 | . | DEL |

3 = Three Calibration Points, Cont.

- With the “Known test weight” screen displayed, place the first calibrated test weight (half the test load) on the scale, enter the value for the test weight and then press the **Save** key.

| CALIBRATE SCALE | | | | |
|--|--------|---|---|-----|
| 500.0 This is the known test weight that is currently on the scale. | | 1 | 2 | 3 |
| | | 4 | 5 | 6 |
| | | 7 | 8 | 9 |
| SAVE | CANCEL | 0 | . | DEL |

- The display will change to show “Working” for a few seconds.

| CALIBRATE SCALE | | | | |
|--|--------|---|---|-----|
| Working This is the known test weight that is currently on the scale. | | 1 | 2 | 3 |
| | | 4 | 5 | 6 |
| | | 7 | 8 | 9 |
| SAVE | CANCEL | 0 | . | DEL |

- With the “Known test weight” screen displayed, place the second calibrated test weight (full test load) on the scale, enter the setting for the test weight, and then press the **Save** key.

| CALIBRATE SCALE | | | | |
|---|--------|---|---|-----|
| 1000.0 This is the known test weight that is currently on the scale. | | 1 | 2 | 3 |
| | | 4 | 5 | 6 |
| | | 7 | 8 | 9 |
| SAVE | CANCEL | 0 | . | DEL |

NOTE: A minimum of 50% of the scale's capacity is required for the full test load, however 70% to 100% is recommended.

- The display will change to show “Working” for a few seconds and then return to the Settings Page 5 screen.
- Calibration is now complete.
- Press the **Exit** key to exit Setup and return to the Weight screen.

4 = Four Calibration Points

1. With the “Number of Points” screen displayed, press the 4 key on the touchscreen and then press the **Save** key.

| CALIBRATE SCALE | | | | |
|---|--------|---|---|-----|
| 4 Number of points at which the scale will be calibrated. 1 = SmartCal | 1 | 2 | 3 | |
| | 4 | 5 | 6 | |
| | 7 | 8 | 9 | |
| SAVE | CANCEL | 0 | . | DEL |

2. The display will change to show “To calibrate zero, remove any weight from the scale before proceeding”. Make certain the scale is empty and then press the **Save** key.

| CALIBRATE SCALE | | | | |
|---|--------|---|---|-----|
| 0 To calibrate zero, remove any weight from the scale before proceeding | 1 | 2 | 3 | |
| | 4 | 5 | 6 | |
| | 7 | 8 | 9 | |
| SAVE | CANCEL | 0 | . | DEL |

3. The display will change to show “Working” and after a few seconds change to show the “Known test weight” screen.

| CALIBRATE SCALE | | | | |
|---|--------|---|---|-----|
| Working To calibrate zero, remove any weight from the scale before proceeding | 1 | 2 | 3 | |
| | 4 | 5 | 6 | |
| | 7 | 8 | 9 | |
| SAVE | CANCEL | 0 | . | DEL |

4 = Four Calibration Points, Cont.

4. With the “Known test weight” screen displayed, place the first calibrated test weight (one fourth the test load) on the scale, enter the setting for the test weight and then press the **Save** key.

| CALIBRATE SCALE | | | | |
|---|--------|---|---|-----|
| 250.0 This is the known test weight that is currently on the scale. | 1 | 2 | 3 | |
| | 4 | 5 | 6 | |
| | 7 | 8 | 9 | |
| SAVE | CANCEL | 0 | . | DEL |

5. The display will change to show “Working” and after a few seconds change to show the “Known test weight” screen.
6. With the “Known test weight” screen displayed, place the second calibrated test weight (half the test load) on the scale, enter the setting for the test weight and then press the **Save** key.

| CALIBRATE SCALE | | | | |
|---|--------|---|---|-----|
| 500.0 This is the known test weight that is currently on the scale. | 1 | 2 | 3 | |
| | 4 | 5 | 6 | |
| | 7 | 8 | 9 | |
| SAVE | CANCEL | 0 | . | DEL |

7. The display will change to show “Working” for a few seconds.

4 = Four Calibration Points, Cont.

- With the “Known test weight” screen displayed, place the third calibrated test weight (full test load) on the scale, enter the setting for the test weight, and then press the **Save** key.

| CALIBRATE SCALE | | | | |
|---|--------|---|---|-----|
| 1000.0 This is the known test weight that is currently on the scale. | | 1 | 2 | 3 |
| | | 4 | 5 | 6 |
| | | 7 | 8 | 9 |
| SAVE | CANCEL | 0 | . | DEL |

NOTE: A minimum of 50% of the scale's capacity is required for the full test load, however 70% to 100% is recommended.

- The display will change to show “Working” for a few seconds and then return to the Settings Page 5 screen.
- Calibration is now complete.
- Press the **Exit** key to exit Setup and return to the Weight screen.

LOAD CELL TRIM

Performing Load Cell Trim

1. With the scale turned on and the Weight screen displayed, press the **Menu** key.
2. The display will change to show the Settings Overview 1 screen.

| SETTINGS OVERVIEW 1 | | >>> |
|---|------------------|-------|
| Revision 1.00.09, Display Rev. 1.0.18 | | |
| Audit Trail -- Cal=54, Cfg=12 | | |
| Range 1: 600.0 x 0.2 -- 2: 1000.0 x 0.5 | | |
| Weight Units=lb | Height Units=in | |
| Auto Lock=0 s | Sonar Ht=0.0 cm | |
| Motion=3 div. | Filter=Off | |
| OIML=No | ZeroTrack=10/2 d | |
| USB: SMA | Gravity=0.000000 | |
| Power up zero =No | | |
| Sonar | Exit | Setup |

3. Press **Setup** on the touchscreen.
4. The display will change to show the ENTER PASSCODE screen.

| ENTER PASSCODE | | | | |
|---|--------|---|---|-----|
| Enter passcode to access settings. Press CANCEL to exit. | 1 | 2 | 3 | |
| | 4 | 5 | 6 | |
| | 7 | 8 | 9 | |
| SAVE | CANCEL | 0 | . | DEL |

5. Using the 10-key on the touchscreen, enter 64870 and then press the **Save** key.
6. The display will change to show the Settings Page 1 screen.

| SETTINGS | PAGE 1 |
|-------------------|----------|
| Model: Dialysis | |
| Date: 2/24/2020 | |
| Time: 12:24:44 | |
| Language: English | |
| <<< | Exit >>> |

7. Press the >>> key to advance to the Settings Page 5 screen.

Performing Load Cell Trim, Cont.

| | | |
|----------------------|------|--------|
| SETTINGS | | PAGE 5 |
| Calibrate Scale | | |
| Load Cell Trim | | |
| Power up Zero: No | | |
| Auto Locking: 4 sec. | | |
| <<< | Exit | >>> |

8. Select **Load Cell Trim** from the Settings Page 5 screen.

| | | |
|----------------|------|---|
| LOAD CELL TRIM | | |
| 1: 2.941 mV | - | + |
| 2: 3.334 mV | - | + |
| 3: 3.148 mV | - | + |
| 4: 1.747 mV | - | + |
| 0.00 | Exit | |

9. Place a test weight of at least 10% of the scale capacity on each corner of the scale, one at a time, and note the reading for each corner.
10. Place a test weight on the corner with the lowest reading and adjust the appropriate cell mV reading until the reading agrees with the highest reading obtained in Step 9.

Press the **+** key to increase the mV reading

Press the **-** key to decrease the mV reading for each cell.

Performing Load Cell Trim, Cont.

11. Repeat Step 10 until all corners have the same reading.

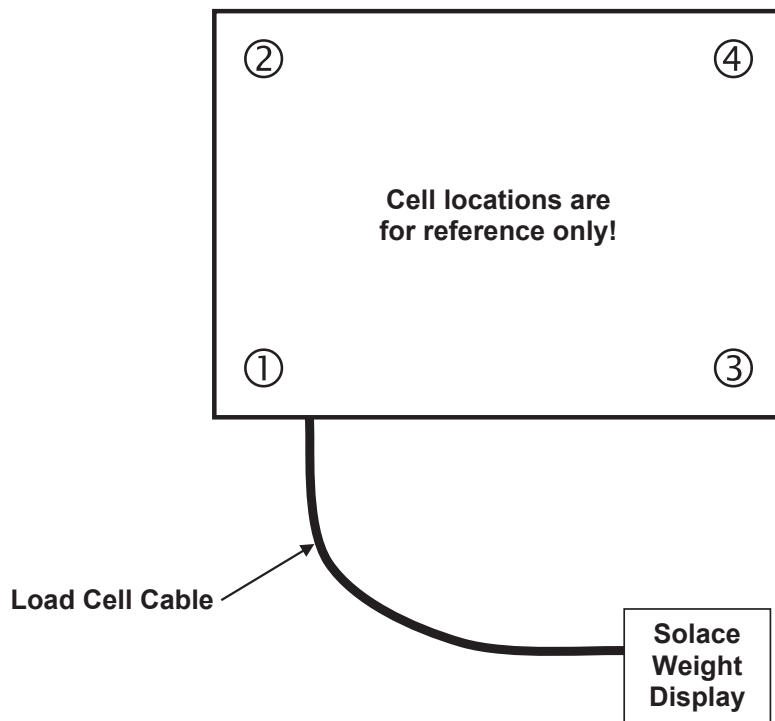

12. Press the **Exit** key to exit Load Cell Trim and return to the Settings Page 5 screen.

13. Press the **Exit** key again to exit Setup and return to the Weight screen.

WI-FI AND BLUETOOTH 5.0

The Detecto Solace In-Floor Dialysis Scale has a Wi-Fi and Bluetooth 5.0 wireless transmitter inside the weight display that has been designed for an environment where interfacing the scale to a Wi-Fi network or pairing to a Bluetooth-capable device is desired.

The following sections will guide you through the setup and operation of the Wi-Fi and Bluetooth 5.0 features of the scale.

Wi-Fi Features

- Soft Access Point (AP) for setting credentials for Wi-Fi module
- Setup option to select a static or dynamic IP address
- Built-in webserver to display weight, height, and BMI
- TCP/IP connection for continuous output of weight, height, and BMI

WI-FI SETUP

Enable and Configure Wi-Fi Networking

NOTE: Default Network Settings are: Wi-Fi = Off, Bluetooth = Off, and DHCP = On.

1. With the scale turned on and the Weight screen displayed, press the **Menu** key.
2. The display will change to show the Settings Overview 1 screen.

| SETTINGS OVERVIEW 1 >>> | | |
|---|-------------------|-------|
| Revision 1.00.09, Display Rev. 1.0.18 | | |
| Audit Trail -- Cal=4, Cfg=2 | | |
| Range 1: 600.0 x 0.2 -- 2: 1000.0 x 0.5 | | |
| Weight Units=lb | Height Units=in | |
| Auto Lock=5 s | Sonar Ht=221.5 cm | |
| Motion=3 div. | Filter=Off | |
| OIML=No | ZeroTrack=10/2 d | |
| USB: SMA | Gravity=0.000000 | |
| Power up zero=No | | |
| Sonar | Exit | Setup |

3. Press **Setup** on the touchscreen.
4. The display will change to show the ENTER PASSCODE screen.

| ENTER PASSCODE | | | | |
|---|--------|---|---|-----|
| Enter passcode to access settings. Press CANCEL to exit. | 1 | 2 | 3 | |
| | 4 | 5 | 6 | |
| | 7 | 8 | 9 | |
| SAVE | CANCEL | 0 | . | DEL |

5. Using the 10-key on the touchscreen enter 64870, and then press the **Save** key.

Enable and Configure Wi-Fi Networking, Cont.

6. The display will change to show the Settings Page 1 screen.

| SETTINGS | | PAGE 1 |
|-------------------|------|--------|
| Model: Dialysis | | |
| Date: 11/6/2019 | | |
| Time: 12:24:44 | | |
| Language: English | | |
| <<< | Exit | >>> |

7. Press the >>> key to advance to the Settings Page 7 screen.

| SETTINGS | | PAGE 7 |
|----------------|------|--------|
| Bluetooth: Off | | |
| Wi-Fi: Off | | |
| SSID: Dynex617 | | |
| | | |
| <<< | Exit | >>> |

The SSID: value will not be shown if Wi-Fi: = Off.

The page advance will not be shown if Wi-Fi: = Off.

8. Touch the **Wi-Fi:** key to open a selection screen to turn the Wi-Fi wireless transmitter On. Press 1 on the entry screen, and then press the Save key.
9. Touch the **SSID:** key to open a screen that will prompt you to CLEAR SSID. Press 1 on the entry screen, and then press the **Save** key to clear the Wi-Fi credentials.

| CLEAR SSID | | | | |
|--------------------------------|--------|---|---|-----|
| 0 1= Clear wireless profile | 1 | 2 | 3 | |
| | 4 | 5 | 6 | |
| | 7 | 8 | 9 | |
| SAVE | CANCEL | 0 | . | DEL |

Enable and Configure Wi-Fi Networking, Cont.

10. Press the >>> key to advance to the Settings Page 8.

| SETTINGS | | PAGE 8 |
|-------------------|------|--------|
| DHCP: On | | |
| IP: 192.168.0.133 | | |
| NM: 255.255.255.0 | | |
| GW: 192.168.0.1 | | |
| <<< | Exit | |

The settings for NM: and GW: will not be shown if DHCP = On.

11. Touch the **DHCP:** key to open an entry screen to allow you to select the DHCP setting. This setting selects whether the Wi-Fi wireless transmitter will use a dynamic IP address assigned by a DHCP server or a static IP address. Consult your network administrator for the proper selection.

Using the numeric keys, enter a new setting, 0 = Static IP (Off) or 1 = DHCP (On), and then press the Save key.



NOTE: If the setting for **DHCP:** = **Off**, the settings for **NM:** (Netmask) and **GW:** (Gateway Address) will be shown on the touchscreen.

12. Touch the **NM:** key to open an entry screen to enter the Wi-Fi network Netmask for the network the scale will be connected to, and then press the Save key.

The Netmask of the scale should match the Netmask of the other computers on your network. The format for the Netmask is ###.###.###.# (e.g., 255.255.255.0).

13. Touch the **GW:** key to open an entry screen to enter the Wi-Fi network Gateway Address for the network the scale will be connected to, and then press the Save key.

The format for the Gateway address is: #.#.#.# (e.g., 192.168.0.1).

14. Press the **Exit** key to exit Setup and return to the Weight screen.

15. Proceed to the Configure Wi-Fi Network Module section.

Configure Wi-Fi Network Module

Without Wi-Fi credentials, the Wi-Fi module will enter listening mode, in which it functions as a Wi-Fi access point. The SSID of the AP is of the form “REDBIRD_WIFI_XX:XX”, where XX:XX is the last 4-digits of the MAC address. Use a Wi-Fi device, such as a Smartphone, tablet, or laptop to connect to the scale. If the connection fails, try moving the scale to another location or cycling power to the scale.

When the connection has been made, open a web browser, and go to the location **redbird.com**. The “Configure Wi-Fi” page should appear.



The screenshot shows a mobile browser interface. At the top, the time is 2:54 and the address bar shows redbird.com/?refresh=S. The main content area features the Cardinal DETECTO logo and the heading "Configure Wi-Fi". Below this are three input fields labeled "Network Name", "Password", and "Device Name", followed by a red "Connect" button. At the bottom, there is a section titled "Available Networks" with a "Scan" button. A table below this section lists available networks with columns for SSID, Mac Address, and Signal Strength.

| SSID | Mac Address | Signal Strength |
|----------|-------------------|-----------------|
| BLUEROOM | 54:75:D0:B3:0D:AF | -51 |
| Dynex617 | 10:DA:43:82:56:2C | -52 |

Click on the **Scan** button to see a list of available Wi-Fi networks.

Configure Wi-Fi Network Module, Cont.

2:55

redbird.com/?refresh=S

Cardinal
DETECTO

Configure Wi-Fi

Network Name
Dynex617

Password
.....

Device Name
icon scale

Connect

Available Networks **Scan**

| SSID | Mac Address | Signal Strength |
|----------|-------------------|-----------------|
| BLUEROOM | 54:75:D0:B3:0D:AF | -51 |
| Dynex617 | 10:DA:43:82:56:2C | -52 |

Enter the Network Name (SSID), Password, and Device Name (optional) for the network you wish to connect to. Note that the Device Name can be anything. Click on the **Connect** button and the module should try to connect to that network. This may take several seconds. The module will store these network credentials and connect to this network each time the scale is turned on.

Changing the Network Credentials

1. With the scale turned on and the Weight screen displayed, press the **Menu** key.
2. The display will change to show the Settings Overview 1 screen.
3. Press **Setup** on the touchscreen.
4. The display will change to show the ENTER PASSCODE screen.
5. Using the 10-key on the touchscreen, enter 64870 and then press the **Save** key.
6. The display will change to show the Settings Page 1 screen.
7. Press the >>> key to advance to the Settings Page 7 screen.
8. Touch the **SSID:** key.
9. You will be prompted to clear the network credentials.

| CLEAR SSID | | | | |
|------------------------------------|--------|---|---|-----|
| 0 1= Clear wireless profile | 1 | 2 | 3 | |
| | 4 | 5 | 6 | |
| | 7 | 8 | 9 | |
| SAVE | CANCEL | 0 | . | DEL |

10. Press 1 on the entry screen, and then press the **Save** key to clear the credentials.
11. Press the **Exit** key to exit Setup, and return to the Weight screen.
12. Repeat the steps in the Configure Wi-Fi Network Module on the previous page to set the new network credentials.

Display Wi-Fi Network Settings

1. With the scale turned on and the Weight screen displayed, press the **Menu** key.
2. The display will change to show the Settings Overview 1 screen.
3. Press the >>> key to advance to the Settings Overview 2 screen.
4. The scale's Wi-Fi network settings will be shown.
5. Press the **Exit** key to exit Settings Overview 2 and return to the Weight screen.

You should see the status of the Wi-Fi on the Settings Overview 2 screen. If a scan of Wi-Fi networks shows the "REDBIRD_WIFI_XX:XX" AP, then the module is in listening mode. Refer to the **Configure Wi-Fi Network Module** section for the procedure to set the Wi-Fi credentials.

WIFI OPERATION

Web Server

While the scale is connected to a network you can access the hosted web page. To view the web page, proceed to the IP address of the Redbird module with “/webserver.html” added to it. For example, if the IP address is “192.168.0.5”, enter **192.168.0.5/webserver.html** and a page like the following should appear.



TCP/IP Connection

Continuous output is available by TCP/IP connection to the scale's IP address at port 10001.

- The scale will transmit a single set of weight data each time the SMA weight request <LF>W<CR> is received.
- Each time the SMA weight request <LF>R<CR> is received, the scale will transmit weight data continually until another SMA command is received.

SMA format for both command <LF>W<CR> and <LF>R<CR>.

<LF><s><r><n><m><f><xxxxxx.xxx><uuu><CR>

Where:

| | |
|--------------|---|
| LF = | Line feed (hex 0A) = Start of response message |
| s = | Scale Status definition |
| | Z = Center of Zero <xxxxxx.xxx>= 0.000 |
| | O = Over Capacity <xxxxxx.xxx>= +weight |
| | U = Under Capacity <xxxxxx.xxx>= -weight |
| | E = Zero Error (clears when the condition clears) |
| | <space> = None of the above conditions NOTE: For "E" error condition <xxxxxx.xxx>= _____ (center dashes) and "Z", "O", "U" is overridden |
| r = | Range ("1", "2", "3", etc.) always "1" for a single range |
| n = | Mode of Operation (Gross/Net status) |
| | G = Gross normal weight |
| | T = Tare weight (in response to "M" command) |
| | N = Net normal weight |
| | g = gross weight in high-resolution |
| | n = net weight in high-resolution |
| m = | Motion status |
| | M = Scale in Motion |
| | <space> = Scale not in Motion |
| f = | Future = Reserved for future or custom use |
| xxxxxx.xxx = | Weight with a decimal point if necessary |
| uuu = | Units = e. g. lb, kg |
| CR = | Carriage Return (hex 0D) = End of response message |

SMA Commands

Once a TCP/IP connection has been made to the dialysis scale, you can issue SMA commands to it. The scale will respond to the SMA commands in the format shown in the Response column of the WI-FI AND BLUETOOTH SMA COMMANDS table on pages 55 and 56 of this manual.

BLUETOOTH LOW ENERGY (BLE)

The Solace In-Floor Dialysis Scale has a wireless transmitter inside the scale weight indicator that can be configured for Bluetooth Low Energy (BLE). When possible, BLE standard specifications are used (those that are adopted by the Bluetooth SIG). Custom services were created to request indicator and scale information whose communication protocol was developed by the Scale Manufacturers Association (SMA).

Features Available via BLE

- Device Information Service
 - Manufacturer Name
 - Model Number
 - Software Revision
- Battery Service
 - Battery Level Percentage
- Weight Scale Service
 - Weight Measurement
 - Weight Scale Feature
- Custom Services
 - Detecto SMA Service

Enable Bluetooth (BLE) Networking

NOTE: Default Network Settings are: Wi-Fi = Off, Bluetooth = Off, and DHCP = On.

1. With the scale turned on and the Weight screen displayed, press the **Menu** key.
2. The display will change to show the Settings Overview 1 screen.

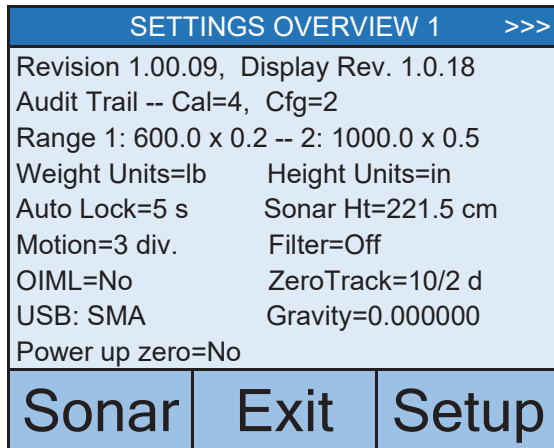

3. Press **Setup** on the touchscreen.

Enable Bluetooth (BLE) Networking, Cont.

- The display will change to show the ENTER PASSCODE screen.

| ENTER PASSCODE | | | | |
|---|--------|---|---|-----|
| Enter passcode to access settings. Press CANCEL to exit. | | 1 | 2 | 3 |
| | | 4 | 5 | 6 |
| | | 7 | 8 | 9 |
| SAVE | CANCEL | 0 | . | DEL |

- Using the 10-key on the touchscreen enter 64870, and then press the **Save** key.
- The display will change to show the Settings Page 1 screen.

| SETTINGS | PAGE 1 | |
|-------------------|--------|-----|
| Model: Dialysis | | |
| Date: 11/6/2019 | | |
| Time: 12:24:44 | | |
| Language: English | | |
| <<< | Exit | >>> |

- Press the >>> key to advance to the Settings Page 7 screen.

| SETTINGS | PAGE 7 | |
|----------------|--------|-----|
| Bluetooth: Off | | |
| Wi-Fi: On | | |
| SSID: Dynex617 | | |
| | | |
| <<< | Exit | >>> |

- Touch the **Bluetooth:** key to open a selection screen to turn the Bluetooth wireless transmitter On. Press 1 on the entry screen, and then press the Save key.

- Press the **Exit** key to exit Setup and return to the Weight screen.

- The scale is now ready to pair with a Bluetooth-capable device.

Enable Bluetooth (BLE) Networking, Cont.



IMPORTANT! If an attempt is made to turn Bluetooth (BLE) off when a device is connected to the scale, the display will show the error message Error - BLE Off.

| SETTINGS | | PAGE 7 |
|-----------------|------|--------|
| Error - BLE Off | | |
| Wi-Fi: On | | |
| SSID: Dynex617 | | |
| | | |
| <<< | Exit | >>> |

This message will be shown until the <<< or >>> keys are pressed to change to a different settings page, the **Exit** key is pressed to return to the Weight screen, or the error message Error - BLE Off is touched, and then CANCEL is selected on the Bluetooth selection screen.

Note that at this time, Bluetooth (BLE) is still on, only the message has been cleared.

To turn Bluetooth (BLE) off, the device must be disconnected from the scale or the scale must be turned Off and back On.

Bluetooth Pairing

To pair a Bluetooth-capable device with the scale, select the name of the scale from the list of available connections: Icon Scale XX:XX:XX:XX:XX:XX. Note that the X's represents the MAC address of the BLE wireless transmitter in the scale's weight indicator.

NOTE: If there are multiple dialysis scales nearby, perform the steps below to proceed to the Settings Overview 2 page to view the scale's Bluetooth Advertisement name (BLE Adv:).

BLE Adv: Icon Scale XX:XX:XX:XX:XX:XX

1. With the scale turned on and the Weight screen displayed, press the **Menu** key.
2. The display will change to show the Settings Overview 1 screen.
3. Press the >>> key to advance to the Settings Overview 2 screen.
4. The scale's Bluetooth setting and Bluetooth Advertisement name will be shown.
5. Press the **Exit** key to exit Settings Overview 2 and return to the Weight screen.

When a stable reading is achieved, and if the scale is paired with a Bluetooth-capable device, the reading will transmit when the device sends a request to receive data.

INTERFACING TO BLE

Note: 16-bit (4-digit) UUID's are adopted standards. 128-bit (32-digit) UUID's are custom services or characteristics.

Standard Services per Bluetooth SIG

Reference adopted specifications at <https://www.bluetooth.com/specifications/gatt>

Device Information Service (0x180A)

| Characteristics | Number | Value(s) | Attributes |
|--------------------------|--------|----------------------------|------------|
| Manufacturer Name String | 0x2A29 | “Detecto” | READ |
| Model Number String | 0x2A24 | “Icon” | READ |
| Software Revision String | 0x2A28 | “1.0.XX” software of scale | READ |

Battery Service (0x180F)

| Characteristics | Number | Value(s) | Attributes |
|-----------------|--------|--|------------|
| Battery Level | 0x180F | 0x00 – 0x64 (uint16), represents 0 – 100 percent | READ |

Weight Scale Service (0x181D)

| Characteristics | Number | Value(s) | Attributes |
|----------------------|--------|---|------------------|
| Weight Measurement | 0x2A9D | <8bit Flag><uint16 weight><uint16 bmi> <uint16 ht> Supported Flags: Flag bit0: 0 = SI, 1 = Imperial bit3: 0 = BMI and Height not present 1 = BMI and Height present bit4: 0 = Not below zero* 1 = Below zero* SI: Wt is KG with resolution 0.0005 Ht is meters with resolution 0.001 Imperial: Wt is lbs with resolution 0.01 Ht is inches with resolution 0.1 | READ INDICATE |
| Weight Scale Feature | 0x2A9E | NOT YET IMPLEMENTED | |

- * • If the weight is below zero (0), the weight you will see is zero (0).
- If the weight is below zero (0), bit 4 of Weight Measurement will be set to 1, otherwise bit 4 is set to zero (0).

NOTE: Maximum weight value displayed is 655.35 in both pounds (lb) and kilograms (kg).

BLUETOOTH INTERFACE STANDARD PROTOCOLS

Bluetooth Characteristic – Weight_Measurement: 0x2A9D

Widely accepted BLE GATT profiles are used to transmit data to other devices/software that have implemented these profiles. Data is passed via BLE using the GATT characteristic "Weight Measurement" (0x2A9D) as defined by Bluetooth SIG. Refer to the data table below about Weight Measurement Characteristics.

Weight_Measurement: 0x2A9D

| NAMES | FIELD REQUIREMENTS | FORMAT | MIN. VALUE | MAX. VALUE | ADDITIONAL INFORMATION | | | | | | | | |
|-------------------|--------------------|------------|------------|----------------|---|------|-------------------|--------------------|--|-----|-------|-----|--------------|
| | | | | | BIT FIELD | | | | | | | | |
| | | Bit | | Size | | Name | | Definition | | | | | |
| | | | | | | | | Key Value Requires | | | | | |
| Flags | Mandatory | 8 bit | N/A | N/A | 0 | 1 | Measurement Units | 0 | SI (Weight and Mass in Units of Kilogram (kg) and Height in Units of Meter) | C1 | | | |
| | | | | | | | | 1 | Imperial (Weight and Mass in Units of Pound (lb) and Height in Units of inch (in)) | C2 | | | |
| | | | | | | | 1 | 1 | Time Stamp Present | 0 | False | | |
| | | | | | | | | | | 1 | True | C3 | |
| | | | | | | | 2 | 1 | User ID Present | 0 | False | | |
| | | | | | | | | | | 1 | True | C4 | |
| | | | | | | | 3 | 1 | BMI and Height Present | 0 | False | | |
| | | | | | | | | | | 1 | True | C5 | |
| 4 | 1 | Below Zero | 0 | Not Below Zero | | | | | | | | | |
| | | | 1 | Below Zero | | | | | | | | | |
| Weight - SI | C1 | uint16 | N/A | N/A | Information: Unit is in kilograms with a resolution of 0.005 and is determined when bit 0 of the Flags field is set to 0. Unit: org.bluetooth.unit.mass.kilogram Exponent: Decimal, -3 Multiplier: 5 | | | | | | | | |
| Weight - Imperial | C2 | uint16 | N/A | N/A | Information: Unit is in pounds with a resolution of 0.01 and is determined when bit 0 of the Flags field is set to 1. Unit: org.bluetooth.unit.mass.pound Exponent: Decimal, 02. | | | | | | | | |
| Time Stamp | C3 | | N/A | N/A | Information: Smallest unit in seconds Unit: org.bluetooth.characteristic.date.time | | | | | | | | |
| User ID | C4 | uint8 | N/A | N/A | The special value of 0xFF (255 Decimal) for User ID represents "unknown user". Information: Unit is unitless with a resolution of 1 <table border="1" style="width: 100%; border-collapse: collapse;"> <thead> <tr> <th>Key</th> <th>Value</th> </tr> </thead> <tbody> <tr> <td>255</td> <td>Unknown user</td> </tr> </tbody> </table> Unit: org.bluetooth.unit.unitless Exponent: Decimal, 0 | | | | | Key | Value | 255 | Unknown user |
| Key | Value | | | | | | | | | | | | |
| 255 | Unknown user | | | | | | | | | | | | |
| BMI | C5 | uint16 | N/A | N/A | Information: Unit is unitless with a resolution of 0.1 Unit: org.bluetooth.unit.unitless Exponent: Decimal, -1 | | | | | | | | |
| Height - SI | C1 C5 | uint16 | N/A | N/A | Information: Unit is in meters with a resolution of 0.001 and is determined when bit 0 of the Flags field is set to 0. Unit: org.bluetooth.unit.length.meter Exponent: Decimal, -3 | | | | | | | | |
| Height - Imperial | C2 C5 | uint16 | N/A | N/A | Information: Unit is in inches with a resolution of 0.1 and is determined when bit 0 of the Flags field is set to 1. Unit: org.bluetooth.unit.length.inch Exponent: Decimal, 0-1 | | | | | | | | |

BLUETOOTH INTERFACE STANDARD PROTOCOLS, CONT.

Custom Services

Detecto SMA Service (0x907a0000-8699-47dd-ab30-d7aad5f83e54)

All custom characteristics have the same base number of the Service UUID 0x907aXXXX-8699-47dd-ab30-d7aad5f83e54 where the XXXX part distinguishes the service.

| Characteristics | Sub Number | Value(s) | Attributes |
|-----------------|------------|---|------------|
| Rx Cmd | 0001 | SMA string received by scale (up to 20 chars) | WRITE |
| Tx Cmd | 0002 | SMA string sent by scale (up to 20 chars) | NOTIFY |

SMA Commands

The SMA commands shown in the WI-FI AND BLUETOOTH SMA COMMANDS table on pages 55 and 56 of this manual can be sent using the Detecto SMA Service's Rx Cmd characteristic (0x907a0001-8699-47dd-ab30-d7aad5f83e54).

Responses will put out a notification on the Tx Cmd characteristic (0x907a0002-8699-47dd-ab30-d7aad5f83e54).

WI-FI AND BLUETOOTH SMA COMMANDS

The format used to send SMA commands to the scale is:

<LF>command<CR>

Where “command” is the ASCII letter(s), or the Hex Rep. listed in the table below. For example, <LF>Z<CR> or 0A5A0D would send the command to zero the scale. Note that the response of each command is listed under the Response column of the table.



Any invalid command sent will return a *question mark* for a response. For example, sending a <LF>XZ<CR> will return 0A 3F 0D (<LF>?<CR>).

| Command | Hex Rep. | Response |
|---|----------|--|
| Z – zero scale | 0A5A0D | None. You should see scale zero itself. |
| D – scale diagnostics | 0A440D | 0A 20 20 20 20 0D = means there are no errors, EEPROM error will show an E in the second space and C will show in the third space if there is a calibration error. 20 = SPACE |
| W – request weight | 0A570D | 0A 5A 31 47 20 20 30 30 30 30 30 2E 30 30 6C 62 0D = Z1G 000000.00lb |
| H – request high resolution weight | 0A480D | 0A 5A 31 67 20 20 30 30 30 30 30 2E 30 31 6C 62 0D = Z1g 000000.01lb |
| A – about scale first line | 0A410D | 0A 53 4D 41 3A 32 2F 31 2E 31 0D = SMA:2/1.1 |
| B – about scale scroll | 0A420D | Each time sent you will get the next line of information until there is no longer any information. 1. 0A 4D 46 47 3A 44 65 74 65 63 74 6F 0D = MFG:Detecto 2. 0A 4D 46 44 3A 41 70 65 78 0D = MOD:lcon 3. 0A 52 45 56 3A 31 2E 30 2E 31 34 0D = REV:X.X.XX 5. 0A 45 4E 44 3A 0D = END: 6. If B is sent again you will get the unknown command response until the A command is sent again. 0A 3F 0D = ? |
| I – scale information | 0A490D | 0A 53 4D 41 3A 32 2F 31 2E 31 0D = SMA:2/1.1 |

WI-FI AND BLUETOOTH SMA COMMANDS, CONT.

| Command | Hex Rep. | Response |
|---|----------|--|
| N – scale information scroll | 0A4E0D | <p>Each time sent you will get the next line of scale information until there is no longer any information.</p> <p>1. 0A 54 59 50 3A 53 0D = TYP:S</p> <p>2. 0A 43 41 50 3A 20 6C 62 3A 36 30 30 2E 30 3A 32 3A 31 0D = CAP: lb:600.0:2:1, this depends on the settings of the lcon. 600.0 – Capacity, 2 – Interval, & 1 – Decimal</p> <p>3. 0A 43 4D 44 3A 48 52 49 4E 58 0D = CMD: HRINX</p> <p>4. 0A 45 4E 44 3A 0D = END:</p> <p>5. If N is sent again you will get the unknown command response until the I command is sent again. 0A 3F 0D = ?</p> |
| R – Repeat Displayed Weight Continuously | 0A520D | <p>0A 5A 31 47 20 20 30 30 30 30 30 2E 30 30 6C 62 0D = Z1G 000000.00lb, you should get this continuously until another SMA command is received.</p> |
| XB – battery level percentage | 0A58420D | <p>0A 38 36 2E 32 35 0D = 86.25</p> |

DISPLAY SCALE WI-FI AND BLUETOOTH SETTINGS

To View the Settings:

1. Press the  key to turn the scale on.
2. The scale will show the Detecto logo briefly and then change to the Weight screen.
3. With the Weight screen displayed, press the **Menu** key.
4. The display will change to show the Settings Overview 1 screen.

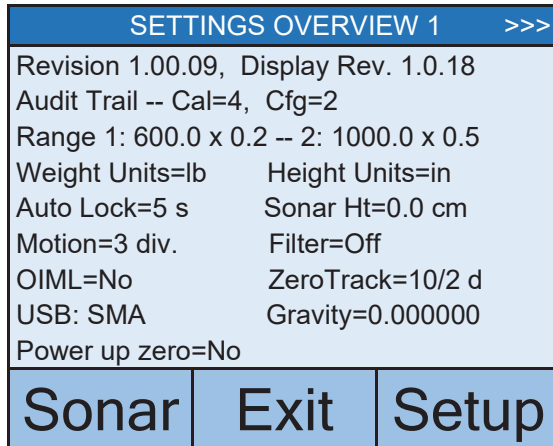

5. Press >>> on top right of touchscreen to advance to the Settings Overview 2 screen.

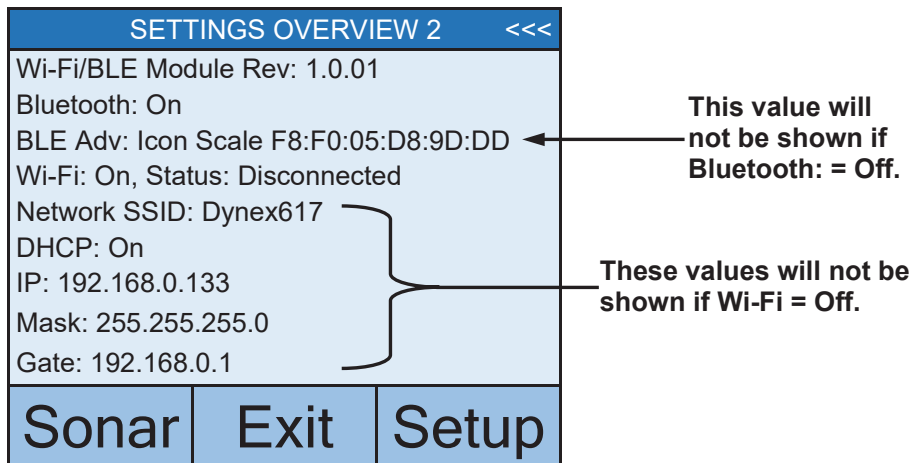

6. Press the **Exit** key to exit the Settings Overview screen and return to the Weight screen.

ERROR AND OPERATION MESSAGES

The Solace In-Floor Dialysis Scale is equipped with diagnostic software that tests various portions of the scale's circuitry and verifies proper operation. Should a problem be detected, an error or status message will be displayed. The following lists these messages and their meaning.

AUTO LOCKED

This message appears if the weight/height has been automatically locked.

BELOW ZERO

The scale weight reading is below zero.

CAL REQUIRED

The indicator requires calibration. Weight will show as dashes. Consult your scale service representative.

CENTER ZERO

The scale weight reading is at the center of zero.

ERROR CANNOT ZERO

Scale cannot zero due to motion on scale.

LOCKED

This message appears if the weight/height has been manually locked.

MOTION

The scale is in motion based on the motion range setting.

OVER CAPACITY

The scale weight exceeds scale capacity.

OVERFLOW ERROR

This message appears if there are too many characters to display on the screen. This message appears if there are too many characters to display on the screen.

BEFORE YOU CALL FOR SERVICE

| Problem | Possible Solutions |
|-------------------------------|--|
| The display does not turn on | <ul style="list-style-type: none">• Is the AC power cord fully inserted into the wall receptacle?• Check wall receptacle for proper AC power. Try another electrical appliance in the same receptacle. Does it work?• Check the circuit breaker.• Has there been a power failure? |
| Incorrect weight is displayed | Ensure that an adjacent object is not touching the scale platform. Have proper operation procedures been followed? |
| Weight is not displayed | Refer to Error and Operation Messages. |

CHANGING THE PAPER ROLL AND RIBBON CARTRIDGE

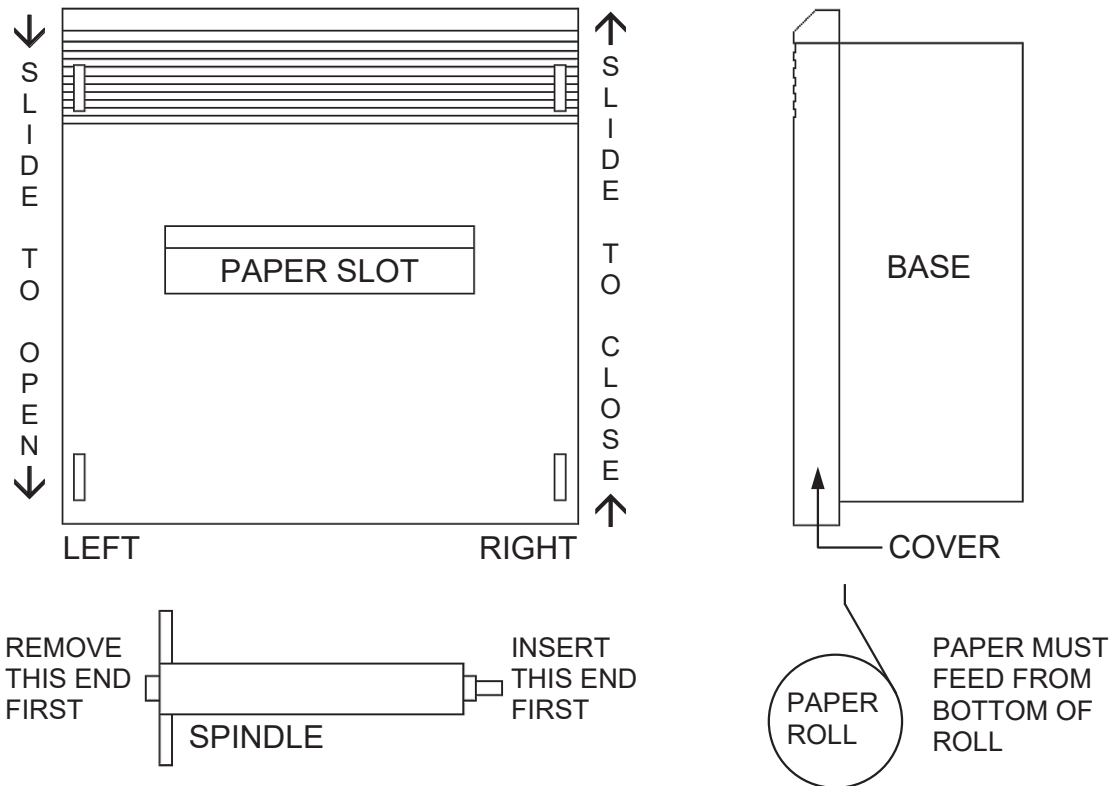

To Change the Paper Roll

1. Referring to the upper two images, slide the cover in the direction indicated to OPEN, and then lift the cover off the base and set aside. Note the cover will only move one-half inch.
2. With a rotating motion, lift the LEFT end of the paper spindle first, then remove it.
3. Insert the end of the new roll of paper into the paper slot of the printer mechanism with the paper coming off the roll at the bottom as shown in the lower right image.
4. Use the paper feed switch to advance the paper so that it extends at least three inches above the printer.
5. Place the spindle in the new paper roll with the two round shafts on the left end.
6. Insert the RIGHT end of the paper spindle in its holder first, and then snap the LEFT end of the spindle into position.
7. Feed the loose end of the paper through the paper slot and locate the cover flush with the base at the position one-half inch from the top.
8. Referring to the upper two images, slide the cover in the direction indicated to CLOSE and snap it into position.

To Change the Ribbon Cartridge

1. Referring to the upper two images, slide the cover in the direction indicated to OPEN, and then lift the cover off the base and set aside. Note the cover will only move one-half inch.
2. Use the paper feed switch to advance the paper so that it extends at least three inches above the printer.
3. Press down on the left end of the ribbon where it is marked PUSH, and then lift both ends to remove the old ribbon.
4. Turn the knob on the right end of the ribbon (as needed to keep the ribbon tight) while placing the new ribbon over the extended paper, and then snap it down firmly into place.
5. Feed the loose end of paper through the paper slot and locate the cover flush with the base at the position one-half inch from the top.
6. Referring to the upper two images, slide the cover in the direction indicated to CLOSE and snap it into position.

CARE AND CLEANING



NOTE: The scale contains no user-serviceable parts and maintenance should be limited to occasional cleaning.

General Cleaning Instructions

- Always remove the power before cleaning.
- DO NOT pour or spray water directly on the indicator to clean. The indicator is not waterproof and covering it with water will damage it and void the warranty.
- DO NOT use wire brushes, abrasives, or cleaning tools such as steel pads and scrapers, which will scratch the surface. Instead, use soft cloths or plastic scouring pads for cleaning.
- DO clean the indicator with a damp soft cloth and mild non-abrasive detergent.
- When possible, use treated water. Hard water can leave behind deposits. Soft water is much gentler on the indicator's surface.
- Avoid the use of acetone, thinner or other volatile solvents, and abrasive type cleaners for cleaning. If required, a mild solvent such as mineral spirits can be used to remove oil, grease, tars, wax, and similar substances. Use a cloth dampened with mineral spirits, and apply only to contaminated areas. Follow up the use of this mild solvent with detergent cleaning and rinsing.

Stainless Steel Cleaning Instructions

While stainless steel is a sturdy and attractive material, it is not incorruptible. Stainless steel is susceptible to rusting. Three basic things can break down stainless steel's outer layer and allow corrosion.

1. Mechanical abrasion - those things which will scratch the steel's surface, such as steel pads, wire brushes, and scrapers. Instead, use soft cloths or plastic scouring pads for cleaning and brush with the polish line or "grain." Clean food equipment frequently to avoid build-up.
2. Water - especially hard water which can leave behind deposits. When possible, use treated water - soft water is much gentler on the stainless steel's surface.
3. Chlorides - often found in water, food, and table salt. One of the worst perpetrators of chlorides can come from household and industrial cleaners, especially those with quaternary salts. Never use hydrochloric acid (muriatic acid) on stainless steel. Instead, use non-chloride cleaners. If chlorinated cleaners must be used, rinse several times, and wipe dry immediately.

STATEMENT OF LIMITED WARRANTY

Conditions Which Void Limited Warranty

This warranty shall not apply to equipment which:

- A.) Has been tampered with, defaced, mishandled or has had repairs and modifications not authorized by Detecto.
- B.) Has had serial number altered, defaced, or removed.
- C.) Has not been grounded according to Detecto's recommended procedure.

Freight Carrier Damage

Claims for equipment damaged in transit must be referred to the freight carrier in accordance with freight carrier regulations.

This warranty sets forth the extent of our liability for breach of any warranty or deficiency in connection with the sale or use of the product. Detecto will not be liable for consequential damages of any nature, including but not limited to, loss of profit, delays or expenses, whether based on tort or contract. Detecto reserves the right to incorporate improvements in material and design without notice and is not obligated to incorporate improvements in equipment previously manufactured.

The foregoing is in lieu of all other warranties, express or implied including any warranty that extends beyond the description of the product including any warranty of merchantability or fitness for a particular purpose. This warranty covers only those Detecto products installed in the forty-eight (48) contiguous continental United States.



08/27/2014
Printed in USA
D268-WARRANTY-DET-A

