

Eco-Stim™

TENS + EMS

Instruction Manual



NC89481

Be sure to read this instruction manual before operating device.
Keep manual in a safe place.

North Coast Medical does not guarantee its content and reserves the right to improve and amend it at any time without prior notice. However, Amendments will be published in a new edition of this manual.

All Rights Reserved.
© 2021, North Coast Medical, inc.

TABLE OF CONTENTS

QUICK REFERENCE GUIDE	4
1. FOREWORD	6
2. SAFETY INFORMATION	8
3. GETTING TO KNOW YOUR DEVICE	13
4. SPECIFICATION	16
5. OPERATING INSTRUCTION	17
6. INSTRUCTIONS FOR USE	24
7. CLEANING AND MAINTENANCE	31
8. TROUBLESHOOTING	32
9. STORAGE	34
10. DISPOSAL	34
11. ELECTROMAGNETIC COMPATIBILITY (EMC) TABLES	35
12. NORMALIZED SYMBOLS	40
13. WARRANTY	41

North Coast Medical declares that the device complies with the following normative documents:
IEC60601-1, IEC60601-1-2, IEC60601-1-11, IEC60601-2-10, IEC62304, ISO10993-5, ISO10993-10, ISO10993-1, ISO14971

QUICK REFERENCE GUIDE

Please read the instruction manual completely before attempting to use this device. Steps 1-3 should be completed with the device turned off.

- 1) **Open the battery cover, insert four batteries (type AAA) into the battery compartment.** Make sure you are installing the batteries properly. Place the batteries according to the markings of positive terminal(+) and negative terminal(-) in the battery compartment of device. (More info on pg.17-18)

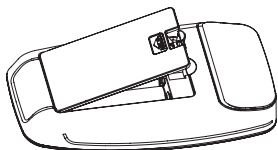

- 2) **Insert the electrode wire connector into the electrode connector.** Make sure the two components are properly connected to ensure optimal performance. Select one of the two available channels and insert the lead wire firmly into the device port.

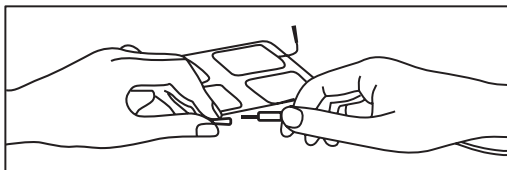

- 3) **Place the electrode on the location where you feel pain.** Refer to section 5.4.3 for correct electrode placement for different body parts after reading 2.2.1 ⚠️ Contraindications and 2.2.3 Precautions.

- 4) **Press the [ON/OFF/M] button to turn on the device.** The LCD will light up, and then go into standby mode. Based on your needs, press [ON/OFF/M] button to select the treatment mode:

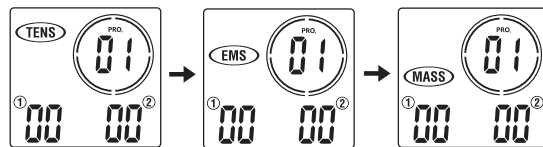

- 5) **Select treatment program.** Based on your needs, press [P] button to select the treatment program.
- 6) **Set program parameter.** Press and hold [P] button to enter the setting mode. In programs p1 to p6 of the TENS mode, and programs p1 to p5 of the EMS mode, Press [+] / [-] button to adjust treatment time. (More info on pg. 25)
- 7) In programs U1 to U3 of the TENS mode, and programs U1 to U3 of the EMS mode, press [P] button to adjust pulse rate -> pulse width -> treatment time by setting the parameters. Press [+] / [-] button to adjust.

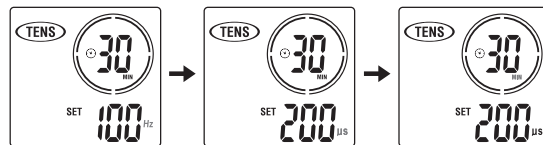

- 8) **Start treatment.** Press the [+] / [-] button of CH1 or CH2 to increase or decrease intensity.
- 9) **Stop treatment.** Press [ON/OFF/M] button to stop treatment and return to the standby mode.

1. FOREWARD

Introduction

The Norco® Eco-Stim™ TENS + EMS is a dual channel output TENS, EMS and MASSAGE stimulator. Before using, please read all the instructions in this user manual carefully and keep it in a safe place for future use.

The Eco-Stim™ TENS + EMS belongs to the group of electrical stimulation systems. It has three basic functions: TENS (Transcutaneous Electrical Nerve Stimulation), EMS (Electronic Muscle Stimulation) and MASSAGE.

Function of the Eco-Stim™ TENS + EMS: The device has 22 programs (9 TENS programs, 8 EMS programs and 5 MASSAGE programs) and applies electric currents in the low-frequency range for therapy. Each program controls the generated electric impulses, intensity, frequency and pulse width.

Based on simulating the body's natural pulses, the mechanism of electrical stimulation equipment is to create electric impulses that are transcutaneous transmitted to nerves or muscle fibers through the electrode. The intensity of the dual channel can be adjusted independently and applied individually to one body part. This dual channel device can be used with four electrodes, which allow you to stimulate one muscle group simultaneously with a wide selection of standard programs. The electrical pulse is first transmitted to the tissue, and then affects the transmission of stimulation in nerves as well as muscle tissues in the body parts.

1.2 Medical background

1.2.1 ABOUT PAIN

Pain is an important signal in the human body warning system. It reminds us that something is wrong, without which, abnormal conditions may go undetected, causing damage or injury to vital parts of our bodies.

Pain does not occur until encoded messages travel to the brain where they are decoded, analyzed, and reacted to. The message is transmitted via different nerves that travel up the spinal cord to the brain. Pain is felt when the brain interprets the message.

1.2.2 WHAT IS TENS?

TENS (Transcutaneous Electrical Nerve Stimulation) is often effective for pain relief. It is used daily and clinically proven by physiotherapists, caregivers and top athletes around the world. High-frequency TENS activates the pain-inhibiting mechanisms of the nervous system. Electrical impulses from electrodes, placed on the skin over or near the pain area stimulate the nerves to block the pain signals to the brain, causing the pain to go unperceived. Low-frequency TENS facilitate the release of endorphins, the body's natural painkillers.

1.2.3 WHAT IS EMS?

Electrical Muscle Stimulation is an internationally accepted and proven way of treating muscular injuries. It works by sending electronic pulses to the muscle being treated and causes the muscle to exercise passively. It is a product derived from the square waveform, originally invented by John Faraday in 1831. Through the square wave pattern, it is able to work directly on muscle motor neurons. The EMS System uses low frequency and in conjunction with the square wave pattern allows direct work on muscle groups.

1.2.4 WHAT IS MASSAGE?

The massage function is a non-medical function. The Massage stimulation program provides relaxing muscle vibration to loosen tight muscles.

2. SAFETY INFORMATION

2.1 Intended Use

TENS mode

TENS mode is used for temporary relief of pain associated with sore and aching muscles in the neck, shoulder, back, upper extremities (arm) and lower extremities (leg) due to strain from exercise or normal household activities.

EMS mode

EMS mode is designed to stimulate healthy muscles in order to improve and facilitate muscle performance.

Users must be 18 years or older.

2.2 Important Safety Precautions and Warnings



It is important to read all warnings and precautions in this manual because they are intended to keep you safe, prevent injury and avoid a situation that could result in damage to the device.

SAFETY SYMBOLS USED IN THIS MANUAL

2.2.1 Contraindication

- 1) Do not use this device if you are using a cardiac pacemaker, implanted defibrillator, or other implanted metallic or electronic devices. Such use could cause electric shock, burns, electrical interference, or death.
- 2) The device should not be used when cancerous lesions or other lesions are present in the treatment area.
- 3) Stimulation should not be applied over swollen, infected, inflamed areas or skin eruptions (e.g. phlebitis, thrombophlebitis, varicose veins, etc.).

- 4) Electrode placements must be avoided in the carotid sinus area (anterior neck) or transcerebrally (through the head).



- 5) This device should not be used in overly enervated areas.
- 6) Inguinal hernia.
- 7) Do not use on scarred areas following a surgery for at least 10 months after the operation.
- 8) Do not use with severe arterial circulatory problems in the lower limbs.

2.2.2 Warning

- 1) If you have had medical or physical treatment for your pain, consult with your physician before use.
- 2) If your pain has not subdued, becomes more than mild, or lasts for more than five days, stop using the device and consult with your physician.
- 3) Do not apply stimulation over your neck because this could cause severe muscle spasms resulting in closure of your airway, difficulty in breathing, or adverse effects on heart rhythm or blood pressure.
- 4) Do not apply stimulation across your chest because the introduction of electrical current into the chest may cause rhythm disturbances to your heart, which could be lethal.
- 5) Do not apply stimulation over, or in proximity to cancerous lesions.
- 6) Do not apply stimulation in the presence of electronic monitoring equipment (e.g. cardiac monitors, ECG alarms), which may not operate properly when electrical stimulation device is in use.
- 7) Do not apply stimulation while bathing or showering.

- 8) Do not apply stimulation while sleeping.
- 9) Do not apply stimulation while driving, operating machinery, or during any activity when electrical stimulation can put you at risk of injury.
- 10) Apply stimulation only to normal, intact, clean, healthy skin.
- 11) The long-term effects of electrical stimulation are unknown. This electrical stimulation device cannot replace drugs.
- 12) Stimulation should not take place while the user is connected to high-frequency surgical equipment, which may cause burn injuries on the skin under the electrodes, as well as problems with the stimulator.
- 13) Do not use the stimulator in the vicinity of shortwave or microwave therapy equipment, since this may affect the output power of the stimulator.



14) Never use in the thoracic area. Stimulation electrodes should never be placed anywhere on the front of the thorax (marked by ribs and breastbone), and not on the two large pectoral muscles. Placing electrodes in these areas can increase the risk of ventricular fibrillation and lead to cardiac arrest.



- 15) Never place electrodes on eyes, head or face.
- 16) Never place electrodes near genitals.
- 17) Never place electrodes on skin that lacks normal sensation.
- 18) Keep electrodes separated during treatment. It could result in improper stimulation or skin burns if electrodes are in contact with each other.
- 19) Keep the stimulator out of reach of children.
- 20) Consult your doctor if you have any questions.
- 21) Discontinue use and do not increase the intensity level if you feel discomfort during use.

2.2.3 Precautions

- 1) TENS is not effective for pain of central origin including headache.
- 2) TENS is not a substitute for pain medications and other pain management therapies.
- 3) TENS is a symptomatic treatment and, as such, suppresses the sensation of pain that would otherwise serve as a protective mechanism.
- 4) Effectiveness is dependent upon patient selection by a practitioner qualified in the management of pain.
- 5) Since the effects of stimulating the brain are unknown, stimulation should not be applied across your head, and electrodes should not be placed on opposite sides of your head.
- 6) The safety of electrical stimulation during pregnancy has not been established.
- 7) You may experience skin irritation or hypersensitivity due to the electrical stimulation or electrical conductive medium (silica gel).
- 8) If you have suspected or diagnosed heart disease or epilepsy, you should follow precautions recommended by your physician.
- 9) Do not use if you have a tendency to bleed internally, e.g. following an injury or fracture.
- 10) Consult with your physician prior to using the device after a recent surgical procedure, because stimulation may disrupt the healing process.
- 11) Use caution if stimulation is intended to be applied over the menstruating or pregnant uterus.
- 12) For single patient use only.

- 13) This stimulator should not be used by patients who are noncompliant, emotionally disturbed or suffer from dementia.
- 14) The instruction for use is listed and should be obeyed; any improper use may be dangerous.
- 15) Rare cases of skin irritation may occur at the site of the electrode placement following long-term application.
- 16) Do not use this device in the presence of other equipment which sends electrical pulses to your body.
- 17) Do not use sharp objects such as a pencil or ballpoint tip pen to operate the buttons on the control panel.
- 18) Check the electrode connections before each use.
- 19) Electrical stimulators should only be used with the electrodes recommended for use by the manufacturer.

2.2.4 Adverse Reactions

- 1) Possible skin irritation or electrode burn under the electrodes may occur.
- 2) On very rare occasions, first-time users of TENS report feeling light-headed or faint. We recommend that you use the product while seated until you become accustomed to the sensation.
- 3) If the stimulation makes you uncomfortable, reduce the stimulation intensity to a comfortable level and contact your physician if problems continue.

3. GETTING TO KNOW YOUR DEVICE

3.1 Accessories

No.	Description	QTY
1	Eco-Stim™ TENS + EMS	1 pc
2	Electrode pad (2 in x 2 in)	4 pcs
3	Electrode wires	2 pcs
4	Batteries (1.5V, AAA)	3 pcs
5	Instruction manual	1 pc

3.2 LCD display

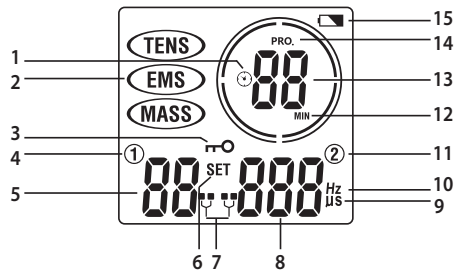

No.	Function Description	No.	Function Description
1	Timer Sign	8	Intensity for Channel 2
2	Treatment mode	8	Symbol of pulse width (μs)
3	Key locking symbol	10	Symbol of pulse rate (Hz)
4	Symbol of Channel 1	11	Symbol of Channel 2
5	Intensity for Channel 1	12	Symbol of treatment time (min)
6	Symbol of SET	13	Program number and Treatment time
7	Indicator of no load (Channel 1 and Channel 2)	14	Symbol of Program
		15	Low battery indicator

3.3 Device Illustration

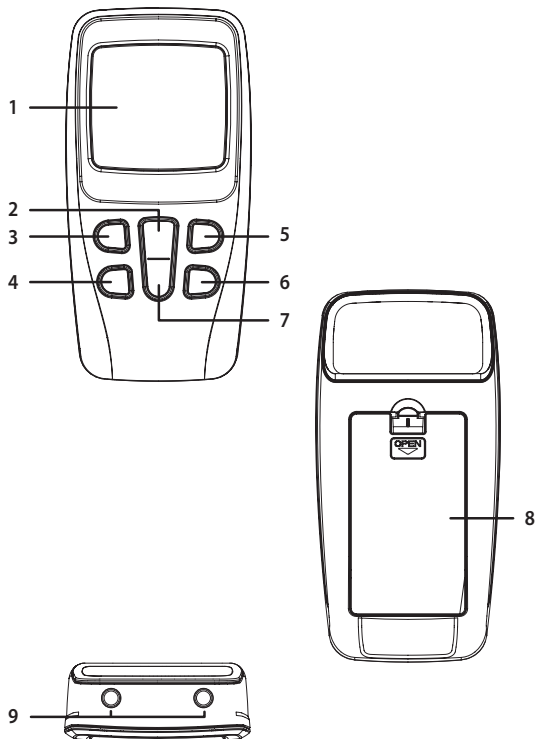

3.3 Device Illustration

No.	Description
1	LCD display
2	[ON/OFF/M] button: In power saving mode, press the [ON/OFF/M] button to turn on the device; In standby mode, press the [ON/OFF/M] button to select treatment mode; In standby mode, press and hold the [ON/OFF/M] button to turn off the device; In treatment mode, press the [ON/OFF/M] button to stop the treatment.
3	[+] button: In standby or treatment mode, press the [+] button to increase the intensity of the CH1; In setting mode, press the [+] button to increase the corresponding data for the pulse rate, pulse width or treatment time.
4	[-] button: In treatment mode, press the [-] button to decrease the intensity of the CH1 At the key locking mode, press the [-] button to unlock the keys. In setting mode, press the [-] button to decrease the corresponding data for the pulse rate, pulse width or treatment time.
5	[+] button: In standby or treatment mode, press the [+] button to increase the CH1 or CH2; At setting mode, press the [+] button to increase the corresponding data for the pulse rate, pulse width or treatment time.
6	[-] button: In treatment mode, press the [-] button to decrease the intensity of CH2; In the key locking mode, press the [-] button to unlock the keys. In setting mode, press the [-] button to decrease the corresponding data for the pulse rate, pulse width or treatment time.
7	[P] button: In standby mode, press the [P] button to select the treatment program. In standby mode, press and hold [P] button to enter the setting mode.
8	Battery cover
9	Output socket

4. SPECIFICATION

4.1 Technical information

Device Name	Norco® Eco-Stim™ TENS + EMS
Model/type	NC89481
Power sources	4.5V D.C., 3x AAA batteries
Output channel	Dual channel
Waveform	Bi-phase square-wave pulse
Output current	Max. 120mA (at 500ohm load)
Output intensity	0 to 40 levels, adjustable
Treatment mode:	TENS, EMS and MASSAGE mode
Operating condition	5° C to 40° C with a relative humidity of 15%-93%, atmospheric pressure from 700 hPa to 1060 hPa
Storage condition	-10° C to 55° C with a relative humidity of 10%-95%, atmospheric pressure from 700 hPa to 1060 hPa
Dimension	109 x 54.5 x 23mm (L x W x H)
Weight	About 70g (without batteries)
Automatic shutoff	1 minute
Classification	BF type applied part, internal power equipment, IP22
Size of electrodes pad	50 x 50mm, square
Output precision	±20% error is allowed for all the output parameters

TENS mode

Number of programs	9 programs
P.W. (Pulse Width)	100-300µs
P.R. (Pulse Rate)	2-100Hz (Hz=vibration per second)
Treatment time	5-90 minutes

EMS mode

Number of programs	8 programs
P.W. (Pulse Width)	100-300µs
P.R. (Pulse Rate)	2-100Hz (Hz=vibration per second)
Treatment time	5-90 minutes

MASSAGE mode

Number of programs	5 programs
P.W. (Pulse Width)	100-250µs
P.R. (Pulse Rate)	2-100Hz (Hz=vibration per second)
Treatment time	5-90 minutes

5. OPERATING INSTRUCTION

5.1 Battery

5.1.1 Check / replace batteries

Open the battery cover, insert four batteries (type AAA) into the battery compartment. Make sure you are installing the batteries properly. Be sure to place the batteries according to the positive terminal (+) and negative terminal (-) markings in the battery compartment of device.

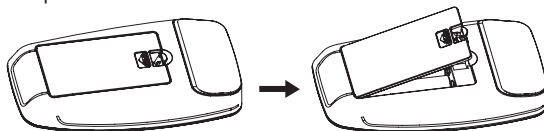

5.1.2 Disposal of battery



Spent batteries should not be placed in household garbage. Dispose of the batteries following your local regulations. As a consumer, you have a legal obligation to dispose of spent batteries properly.

- 1) If a battery was swallowed accidentally, please seek medical assistance immediately!
- 2) In case of battery leakage, please avoid contact with the battery through skin, eyes and mucus membranes. If contact occurs, please wash the contacted body part with plenty of clean water and contact your doctor immediately.
- 3) Batteries should not be dismantled, thrown into fire or short-circuited.
- 4) Protect batteries from excess heat; take the batteries out of the product if they are spent or you don't use it for a long time. This can prevent device from damage due to battery leakage.
- 5) Replace all of the batteries simultaneously.
- 6) Always use the same type of battery when replacing.

5.2 Connect electrode pads to electrode wires

Insert the electrode wire connector into electrode connector. Make sure the two components are properly connected to ensure optimal performance. Please refer to the picture below.

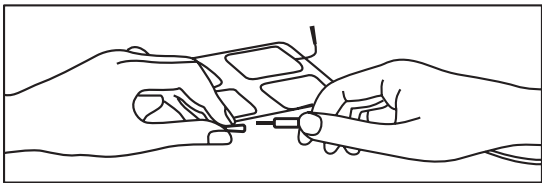

Caution

Always use electrode pads which comply with the requirements of the IEC/EN60601-1, ISO10993-1/-5/-10 and IEC/ EN60601-1-2, as well as CE and FDA 510(K) regulation.

5.3 Connect electrode wires to device

Before proceeding to this step, ensure that the device is completely switched OFF.

Insert the insulated portion of the electrode wire connector and insert the connector into the port on the top of the device.

Ensure the electrode wires are inserted correctly. The device has two output ports controlled by Channel A and Channel B at the top of the unit. You may choose to use one channel with one pair of electrode wires or both channels with two pairs of electrode wires. Using both channels gives the user the advantage of stimulating two different areas at the same time.

Caution

Do not insert the plug of the electrode wires into any AC power supply socket.

5.4 Electrode

5.4.1 Electrode options

The electrodes should be routinely replaced when they start to lose their adhesiveness. If you are unsure of your electrode adhesive properties, please order new replacement electrodes. Follow application procedures outlined on electrode packaging when using the new replacement electrodes to maintain optimal stimulation and to prevent skin irritation.

5.4.2 Place electrodes on skin

Place the electrode on the body part in need of treatment according to the instructions provided in this user manual. Cleaning the skin before use will help ensure the skin and electrode connect well.

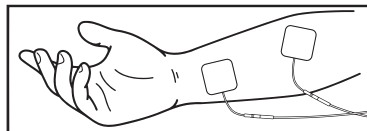

⚠ Caution

- 1) Remove the electrodes from the skin with a light to moderate slow pull in order to avoid injury in the event of highly sensitive skin.
- 2) Before applying the self-adhesive electrodes, it is recommended that the skin be washed and degreased, and then dried.
- 3) Do not turn on the device when the self-adhesive electrodes are not positioned on the body.
- 4) Prior to removing or moving the electrodes, switch off the device or the appropriate channel first in order to avoid unwanted irritation.
- 5) It is recommended that, at minimum, 1.97"x 1.97" self-adhesive square electrodes are used at the treatment area.
- 6) Never remove the self-adhesive electrodes from the skin while the device is still on.

5.4.3 Electrode placement

The Norco® Eco-Stim™ TENS + EMS is an OTC stimulator, suitable for home or clinic use. It should be used in accordance with the user manual. Place the electrode on the position where you feel pain, conduct treatment and adjust based on how it feels.

Position of electrode placement under TENS programs

Neck

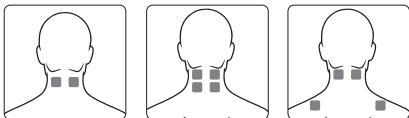

Shoulder

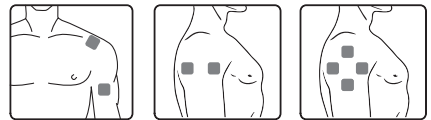

Arm

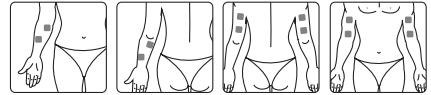

Hand

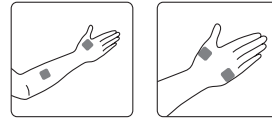

Back

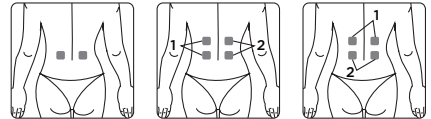

Abdomen

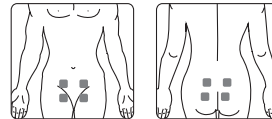

Hip



Leg

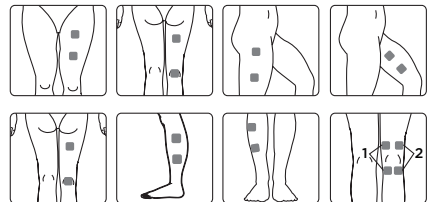

Foot

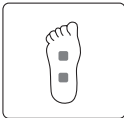

Arm

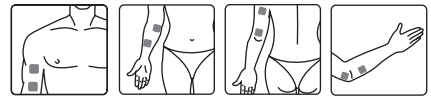

Joint (knee)

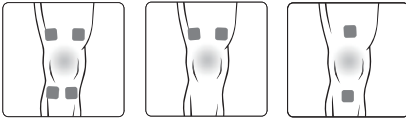

Hand



Joint (elbow)

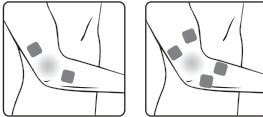

Back

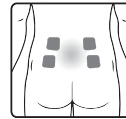

Joint (ankle)

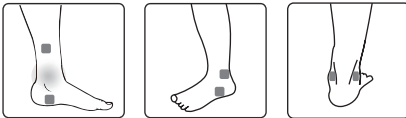

Abdomen

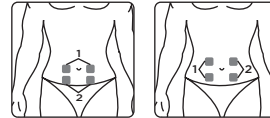

Joint (wrist)

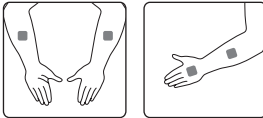

Hip

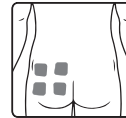

Position of electrode placement under EMS programs

Neck

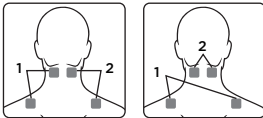

Leg

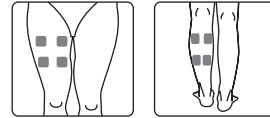

Shoulder

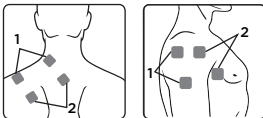

Foot

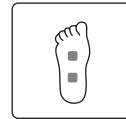

6. INSTRUCTIONS FOR USE

6.1 Turn on

When using device for the first time, open the battery cover and load three new batteries (Please kindly review Section 5.1.1 for the operating steps and schematic diagram).

Press the [ON/OFF/M] button to turn on the device, the LCD will light up and then enter standby mode as shown below.

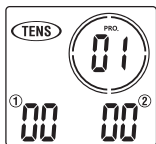

6.2 Select treatment mode

Based on your needs, press [ON/OFF/M] button to select the treatment mode. The LCD displays as follows:

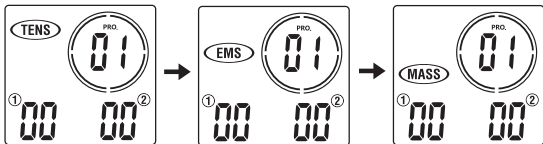

6.3 Select treatment program

Based on your needs, press [P] button to select the treatment program. The LCD displays as follows:

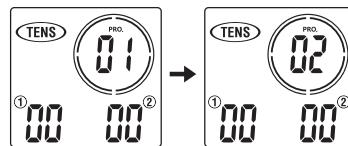

6.4 Set program parameter

Press and hold [P] button to enter the setting mode.

- 1) In the program p1 to p6 of the TENS mode, and the program p1 to p5 of the EMS mode, Press [+] / [-] button to adjust treatment time.

The LCD displays as follows:

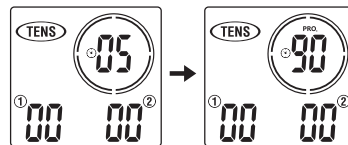

- 2) In the program U1 to U3 of the TENS mode, and the program U1 to U3 of the EMS mode, press [P] button to adjust pulse rate -> pulse width -> treatment time by setting the parameter.

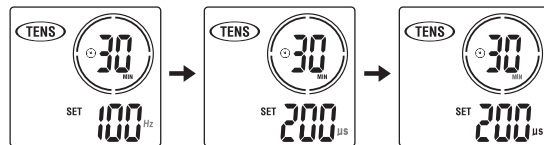

- 3) Press [+] / [-] button to adjust corresponding data.

Treatment mode	Program NO.	Treatment time (min)	Frequency (Hz)	Pulse width (us)	Type
TENS	PU1	Default: 30 Adjustable: (5-90)	Default: 50 Adjustable: (2-100)	Default: 180 Adjustable: (100-300)	Con.
	PU2	Default: 30 Adjustable: (5-90)	Default: 60 Adjustable: (2-100)	Default: 160-260 Adjustable: (100-300)	PWM
	PU3	Default: 30 Adjustable: (5-90)	Default: 60 Adjustable: (2-100)	Default: 260 Adjustable: (100-300)	IM
EMS	PU1	Default: 30 Adjustable: (5-90)	Default: 5 Adjustable: (2-100)	Default: 300 Adjustable: (100-300)	Con.
	PU2	Default: 30 Adjustable: (5-90)	Default: 60 Adjustable: (20-100)	Default: 200 Adjustable: (100-300)	SY
	PU3	Default: 30 Adjustable: (5-90)	Default: 70 Adjustable: (20-100)	Default: 200 Adjustable: (100-300)	AL

4) Press [ON/OFF/M] button to return to the standby mode.

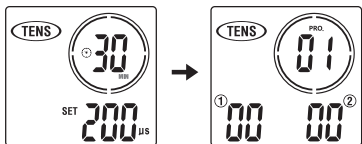

6.5 Start treatment

Press the [+] button of CH1 to increase the channel 1 intensity, press the [+] button of CH2 to increase the channel 2 intensity. The LCD displays as follows:

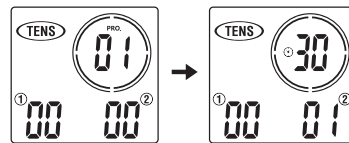

6.6 Adjust the output intensity

Place the electrodes on the body parts, press the [+] button to increase output intensity. Intensity will be increased to a higher level after each press. The device has 40 levels of output intensity. Adjust the intensity to a level you feel comfortable. The level of output intensity will be shown on the LCD:

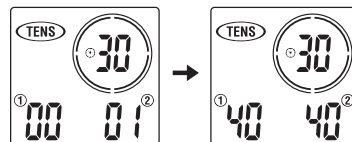

If the intensity is too strong, you can press [-] button to decrease intensity to a lower level. When the output intensity of both channels decreases to zero, the stimulator will return to the standby mode. The LCD displays as follows:

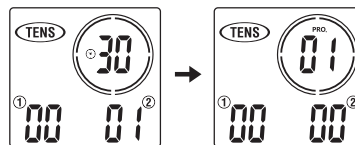

⚠ Caution

If you feel or become uncomfortable, reduce the stimulation intensity to a more comfortable level and consult with your medical practitioner if problems persist.

6.7 Stop the treatment and turn off the device

Press the [ON/OFF/M] button to stop treatment during the treating mode. Press the [ON/OFF/M] button again to turn off the stimulator, and the LCD will be blank.

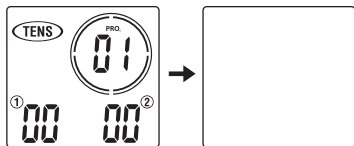

6.8 Load detection

Automatic detection of the load occurs when the intensity is above level 5. If there is no load detection or the electrode contacts has poor contact with the skin, the intensity will automatically return to level 0 and the  symbol flashes. The stimulator will return to standby mode.

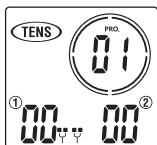

6.9 Low battery detection

When the batteries are low, the  icon will flash. Stop the device and change the batteries.

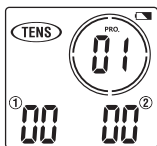

Caution

- 1) Batteries may be fatal if swallowed. Keep the batteries and the product out of children's reach. If a battery is swallowed, go to a hospital immediately.
- 2) If there is battery leakage, avoid contact with skin, eyes and mucus membranes. Rinse the affected spots with plenty of clear water immediately and contact a physician right away.
- 3) Batteries must not be charged, dismantled, or short-circuited.
- 4) Protect batteries from excess heat. Take the batteries out of the device if they are spent or you will no longer use them. This prevents damage caused by leaking batteries.

6.10 Use of electrode pads

- 1) The electrode may only be connected with the Eco-Stim™ TENS + EMS device. Make sure the device is turned off when attaching or removing the electrode pads.
- 2) If you want to reposition the electrode during the application, turn the device off first.
- 3) Electrode use may lead to skin irritations. If you experience such skin irritations, e.g. redness, blistering or itching, discontinue using them. Do not use the Eco-Stim™ TENS + EMS permanently on the same body part, as this may also lead to skin irritations.
- 4) Electrode pads are intended for single patient use and not for use with more than one person.
- 5) The electrode must connect entirely to the skin surface to prevent hot spots, which may lead to skin burns.
- 6) Do not use the electrode pads longer than suggested by electrode manufacturer as the connection between electrodes and skin deteriorates over time.

- 7) The adhesive force of the electrodes depends on skin properties, storage condition, and the number of applications. If your electrode pads no longer fully stick to the skin surface, replace them with new ones. Stick the electrode pads back onto the protective foil after use and store them in the storage bag to prevent them from drying out. This retains the adhesiveness for a longer period.



Caution

- 1) Before applying the electrode, it is recommended that the user's skin be washed and degreased, and then dried.
- 2) Never remove the electrode from the skin while the device is still on.
- 3) Only use the electrode pads recommended by the manufacturer. Use of inferior electrode products could result in injuries to the user.

6.11 Where do I attach electrode pads?

- 1) Each person reacts differently to electric nerve stimulation. Therefore, the placement of the electrodes may deviate from one person to another. If the application is not successful, contact your healthcare provider to find out which placement techniques are best for you.
- 2) Do not use smaller sized adhesive electrodes than what was provided by the original manufacturer, otherwise the current density may be too high and cause injuries.
- 3) The size of the adhesive pads may not be customized, e.g. by clipping off parts of them.
- 4) Make sure that the region radiating the pain is enclosed by the electrodes. In case of painful muscle groups, attach the electrodes in such a way that the affected muscles are also enclosed by the electrodes.

Usage advice for TENS:

If you feel the output intensity too strong, you can press [-] button to decrease it.

If you don't feel any discomfort during the treatment, we advise you to use the device until the session ends. Normally, the pain relief occurs after 5-10 min of treatment; Normally, we advise 1-2 treatments per day and one week as a treatment period.

After a treatment period, if pain relief is not achieved or the pain gets worse, please consult your doctor.

Usage advice for EMS:

Place the electrodes on the body part you want to treat referring to the picture on Section 5.3.3.

1-2 treatments per day, about one week as a treatment period.

We advise that you use the device for one session per time. If you feel discomfort during treatment, you can either pause the session or decrease the intensity of the output.

7. CLEANING AND MAINTENANCE

Fully comply with the following necessary daily maintenance requirements to make sure the device is intact and guarantee long-term performance and safety.

7.1 Cleaning and care for the device

- 1) Disconnect the electrodes from the stimulator. Clean the device with a soft, slightly damp cloth. In case of heavier dirt build-up, you may also apply a mild detergent.
- 2) Do not expose the device to moisture or dampness. Do not hold the device under running water, nor submerge it in water or any liquid.
- 3) The device is sensitive to heat and should not be exposed to direct sunlight. Do not place device on hot surfaces.

- 4) Clean the surface of the electrode pads carefully with a damp cloth after making sure the device is turned off.
- 5) For best hygiene, each user should use his/her own set of electrodes.
- 6) Do not use any chemical cleaners or abrasive agents for cleaning.
- 7) Ensure that no water penetrates into the device. Should this happen, use the device again only when it is completely dry.
- 8) Do not clean the device during treatment. Be sure that the device is turned off before cleaning.

7.2 Maintenance

- 1) The manufacturer has not authorized any maintenance agencies. If your device has any problems, please contact the distributor. The manufacturer will not be responsible for the results of maintenance or repairs by unauthorized persons.
- 2) The user must not attempt any repairs to the device or any of its accessories. Please contact the retailer for repair.
- 3) Opening of the equipment by unauthorized agencies is not allowed and will terminate any claim to warranty.

Each product in manufacturing has been inspected through systematic validation. Calibration and validation is not required for this device.

If your product does not reach the expected performance and the basic function has changed in normal use, please contact the retailer.

8. TROUBLESHOOTING

Should a malfunction occur while using the device, check whether the parameters are set appropriately for therapy, and adjust the control correctly. Please see the following table:

Malfunction	Common reasons	Countermeasure
No display after replacing the batteries	<ol style="list-style-type: none"> 1. There's foreign matter in the battery compartment. 2. The batteries are dead or installed incorrectly. 3. There's foreign matter in the battery interface. 4. The batteries are not the right model or something is wrong with the battery interface. 5. Exception reset 	<ol style="list-style-type: none"> 1. Check and clean the compartment. 2. Replace with new batteries or install the batteries correctly. 3. Check and clean the interface. 4. Replace the batteries with the right model.
No sensation of stimulation	<ol style="list-style-type: none"> 1. The electrode is not connected to the skin well. 2. The electrode wire is not plugged into the unit. 3. The batteries are dead. 4. The skin is too dry. 	<ol style="list-style-type: none"> 1. Check and re-apply to skin. 2. Check the connection. 3. Replace the batteries. 4. Wipe the electrode and the skin with a wet cotton cloth.
Automatic halt in the treatment	<ol style="list-style-type: none"> 1. The electrode loses connection with the skin. 2. The batteries are dead. 	<ol style="list-style-type: none"> 1. Check and place the electrode properly on the skin. 2. Replace the batteries.
Rash or tickle on the skin occurs in the treatment	<ol style="list-style-type: none"> 1. The treatment time lasts too long. 2. The electrode is not in good contact with the skin. 3. The interface of the electrode is dirty or dry. 4. The skin is sensitive to the electrode. 	<ol style="list-style-type: none"> 1. Do the treatment once a day and shorten the treatment time. 2. Stick the electrode to the skin better 3. Wipe the electrode with a wet cotton cloth before use. 4. Check your allergic history. Change the electrode location or shorten the treatment time. If your skin is over-sensitive, stop the treatment or see a doctor.

9. STORAGE

9.1 Storing the Electrode Pads and Lead Wires

- 1) Turn the device off and remove the lead wires from the unit.
- 2) Remove the electrodes from your body and disconnect the lead wires from the electrodes.
- 3) Place the electrodes onto the plastic film and store in the sealed package.
- 4) Wrap the lead wires and store in the sealed package.

9.2 Storing the Unit

- 1) Place the unit, electrodes, lead wires and manual back into the box. Store the box in a cool, dry place, $-10^{\circ}\text{C} \sim 55^{\circ}\text{C}$; 10% ~ 90% relative humidity.
- 2) Do not keep in places that can be easily reached by children.
- 3) When not in use for a long period, remove the batteries before storage.

10. DISPOSAL



Spent batteries should not be placed in the household garbage. Dispose of the batteries according to local regulations. As a consumer, you have the obligation to dispose of batteries properly.

Consult your municipal authority or your dealer for information about disposal.

At the end of the product lifecycle, do not throw this product into the normal household garbage. Bring it to a collection point for the recycling of electronic equipment. Obsolete electrical and electronic equipment may have potentially harmful effects on the environment. Incorrect disposal can cause toxins to build up in the air, water and soil and jeopardize human health.

11. ELECTROMAGNETIC COMPATIBILITY (EMC) TABLES

Guidance and manufacturer's declaration — electromagnetic emissions		
The device is intended for use in the electromagnetic environment specified below. The user of the device should assure it is used in such environment.		
Emissions test	Compliance	Electromagnetic environment - guidance
RF emissions CISPR11	Group 1	The device uses RF energy only for its internal function. Therefore, its RF emissions are very low and are not likely to cause any interference in nearby electronic equipment.
RF emissions CISPR11	Class B	The device is suitable for use in all establishments, including those directly connected to the public low-voltage power supply network that supplies building power used or domestic purposes.
Harmonic emissions IEC 61000-3-2	Not applicable	
Voltage fluctuations / Flicker emissions IEC 61000-3-3	Not applicable	

Guidance and manufacturer's declaration — electromagnetic immunity			
The device is intended for use in the electromagnetic environment specified below. The user of the device should assure it is used in such environment.			
Immunity test	IEC 60601 Test level	Compliance level	Electromagnetic environment - guidance
Electrostatic discharge (ESD) IEC 61000-4-2	±8kV direct & indirect contact; ±15kV air discharge	±8kV direct & indirect contact; ±15kV air discharge	Floors should be wood, concrete or ceramic tile. If floors are covered with synthetic material, the relative humidity should be at least 30%.
Electrical fast transient/burst IEC 61000-4-4	±2 kV for power supply lines	not applicable	not applicable (for internally powered equipment)
Surge IEC 61000-4-5	± 1 kV line(s) to line(s)	not applicable	not applicable (for internally powered equipment)
Voltage dips, short interruptions and voltage variations on power supply input lines IEC 61000-4-11	<5% U_T (>95% dip in U_T) for 0.5 cycle 40% U_T (60% dip in U_T) for 5 cycles 70% U_T (30% dip in U_T) for 25 cycles <5% U_T (>95% dip in U_T) for 5 sec	not applicable	not applicable (for internally powered equipment)
Power frequency (50Hz/60Hz) magnetic field IEC 61000-4-8	10V/m	10V/m	Power frequency magnetic fields should be at levels characteristic of a typical location in typical commercial or hospital environment.
NOTE: U_T is the a.c. mains voltage prior to application of the test level.			

Guidance and manufacturer's declaration — electromagnetic immunity			
The device is intended for use in the electromagnetic environment specified below. The user of the device should assure it is used in such environment.			
Immunity test	IEC 60601 Test level	Compliance level	Electromagnetic environment - guidance
Radiated RF IEC 61000-4-3	10V/m & table 9	10V/m & table 9	<p>Portable and mobile RF communications equipment should be used not closer to any part of the device, including cables, than the recommended separation distance calculated from the equation applicable to the frequency of the transmitter.</p> <p>Recommended separation distance $d=1.167\sqrt{P}$ 80 MHz to 800 MHz $d=2.333\sqrt{P}$ 800 MHz to 2.5 GHz</p> <p>Where P is the maximum output power rating of the transmitter in watts (W) according to the transmitter manufacturer and d is the recommended separation distance in meters (m).</p> <p>Field strength from fixed RF transmitters, as determined by an electromagnetic site survey^a, should be less than the compliance level in each frequency range^b. Interference may occur in the vicinity of equipment marked with the following symbol:</p> 
NOTE 1	At 80 MHz and 800 MHz, the higher frequency range applies.		
NOTE 2	These guidelines may not apply in all situations. Electromagnetic propagation is affected by absorption and reflection from structures, objects and people.		

- a Field strengths from fixed transmitters, such as base stations for radio (cellular/cordless) telephones and land mobile radios, amateur radio, AM and FM radio broadcast and TV broadcast cannot be predicted theoretically with accuracy. To assess the electromagnetic environment due to fixed RF transmitters, an electromagnetic site survey should be considered. If the measured field strength in the location in which the device is used exceeds the applicable RF compliance level above, the device should be observed to verify normal operation. If abnormal performance is observed, additional measures may be necessary, such as reorienting or relocating the device.
- b Over the frequency range 150 kHz to 80 MHz, field strengths should be less than [V] V/m.

Test specifications for ENCLOSURE PORT IMMUNITY to RF wireless communications equipment (Table 9)						
Test frequency (MHz)	Band ^{a)} (MHz)	Service ^{a)}	Modulation ^{b)}	Maximum Power (W)	Distance (m)	Immunity Test Level (V/m)
385	380-390	TETRA 400	Pulse modulation ^{b)} 18Hz	1.8	0.3	27
450	430-470	GMRS 460, FRS 460	FM ^{c)} ±5kHz deviation 1kHz sine	2	0.3	28
710	704-787	LTE Band 13,17	Pulse modulation ^{b)} 217Hz	0.2	0.3	9
745						
780						
810	800-960	GSM800/900, TETRA 800, iDEN 820, CDMA 850, LTE Band 5	Pulse modulation ^{b)} 18Hz	2	0.3	28
870						
930						
1720	1700-1990	GSM1800; CDMA 1900; GSM 1900; DECT; LTE Band 1, 3, 4, 25; UMTS	Pulse modulation ^{b)} 217Hz	2	0.3	28
1845						
1970						
2450	2400-2570	Bluetooth, WLAN, 802.11 b/g/n, RFID 2450, LTE Band 7	Pulse modulation ^{b)} 217Hz	2	0.3	28
5240	5100-5800	WLAN 802.11 a/n	Pulse modulation ^{b)} 217Hz	0.2	0.3	9
5500						
5785						
NOTE: If it is necessary to achieve the IMMUNITY TEST LEVEL, the distance between the transmitting antenna and the ME EQUIPMENT or ME SYSTEM may be reduced to 1 m. The 1 m test distance is permitted by IEC 61000-4-3.						
a) For some services, only the uplink frequencies are included.						
b) The carrier shall be modulated using a 50% duty cycle square wave signal.						
c) As an alternative to FM modulation, 50% pulse modulation at 18Hz may be used because it does not represents actual modulation.						

12. NORMALIZED SYMBOLS



Electrical devices are recyclable material and should not be disposed of with household waste after use! Help us protect the environment and save resources by taking this device to the appropriate collection points. Please contact the organization which is responsible for waste disposal in your area if any questions.



Applied part of type BF



Refer to instruction manual

IP22

The first number 2: Protect against solid foreign objects of 12,5 mm Φ and greater. *The second number:* Protect against vertically falling water drops when enclosure tilted up to 15°. Vertically falling drops shall have no harmful effects when the enclosure is tilted at any angle up to 15°, vertically on either side.

LOT

LOT	<input type="text"/>	<input type="text"/>	<input type="text"/>	<input type="text"/>	<input type="text"/>	<input type="text"/>	<input type="text"/>	<input type="text"/>
	R	Year	Month	Numerical Order				

R: Product Model



Manufactured for:
North Coast Medical, Inc.



Manufacture date

13. WARRANTY

Please contact your dealer or North Coast Medical in case of a claim under the warranty. If you have to return the unit, enclose a copy of your receipt with clear statement of defect description.

Warranty terms:

- 1) The warranty period for this device is 1 year from the date of purchase. In case of a warranty claim, the date of purchase has to be proven by means of the sales receipt or invoice.
- 2) Repairs under warranty should be in the warranty period for the device.
- 3) The following cases are excluded under the warranty:
 - All damages that arise due to improper operation, e.g. nonobservance of the user instructions.
 - All damages due to repairs or tampering by the customer or unauthorized third-parties.
 - Accessories which are subject to normal wear and tear.
 - Device damages due to disassembling device.
- 4) Liability for direct or indirect consequential losses caused by the unit is excluded, even if the damage to the unit is accepted as a warranty claim.

USER NOTES



Eco-Stim™

TENS + EMS

Instruction Manual



North Coast Medical, Inc.