

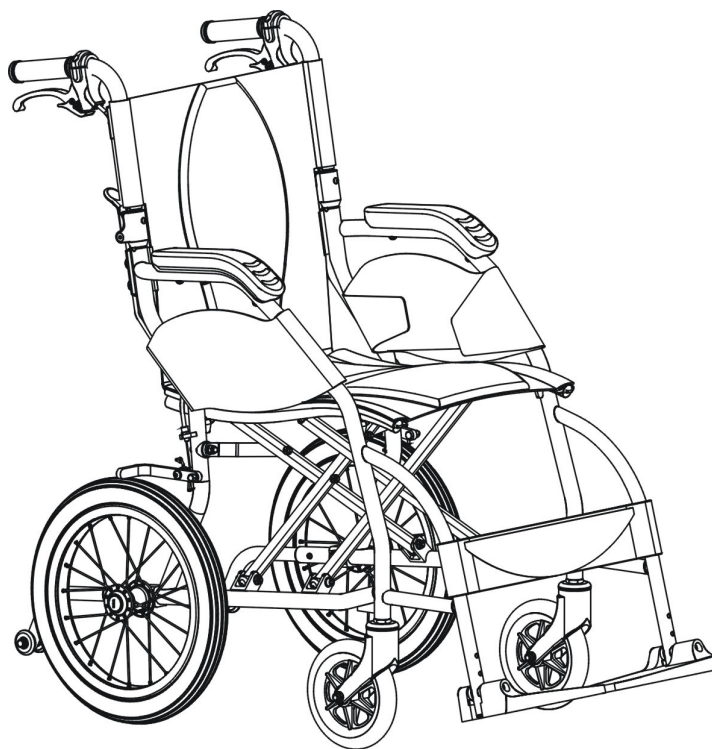

KARMA MEDICAL PRODUCTS CO., LTD.

Manual Wheelchair Owner's Manual

Ergo Lite
(KM-2501)



ISO 9001

Lead the way, all the way!

GENERAL WARNING

- DO maintain your chair well, in particular check the tire pressure since this affects the efficiency of the brakes.
- DO make sure both brakes are applied before getting in or out of the chair.
- DO make sure both brakes are applied when the chair is not being pushed or used.
- DO take care when climbing curb or turning on slopes.
- DO avoid steep or uneven surfaces that may cause the chair to tip over.
- DO avoid soft surfaces because the casters may become bogged down.
- DO travel smoothly in all conditions.
- DO look well ahead to anticipate hazards such as furniture, doors, potholes, slopes, curbs, doorways etc.
- DO make sure that both feet are safely on the footrests and that clothing is safely tucked out of the way so that it cannot get caught in the wheels.
- DO take care when travelling up or down or across inclines.
- DO keep both hands on the push handles to control the chair, if you are the attendant.
- DO pay attention to keep the chair's balance.
- DO check the frame and components regularly and refer to this user guide during and after the warranty period.
- DO tie-up the upholstery or replace which with a new one when it becomes loose.
- DO equip with anti-tippers to avoid falling backwards.
- DO equip with a seat belt designed for disabled people.
- DO equip with "heel loops" for disabled people.
- DO clean both hands after oiling the wheelchair.
- DO keep far away from flame.
- DO NOT overload the chair under any circumstances.
- DO NOT hang anything heavy on the back of the chair that could cause the chair to become unstable, particularly when negotiating inclines.
- DO NOT allow more than one user at a time.
- DO NOT use with an unconscious patient.
- DO NOT use other transport to pull the wheelchair.
- DO NOT do "wheelies", since you may fall or tip over backwards and suffer a severe injury.
- DO NOT sit in the wheelchair within a moving vehicle unless it has been affixed the labels of hook mark.
- DO NOT go too fast or turn too quickly.
- DO NOT travel across a slope (in any direction) greater than 7 degrees.
- DO NOT stand on the footplates when getting in or out of the chair.
- DO NOT go down steps forward, whether solo or with an attendant.
- DO NOT attempt to lift the wheelchair by any removable (detachable) parts. Lifting by means of any removable (detachable) parts of the wheelchair may result in injury to the user and/or assistant or damage to the wheelchair.
- DO NOT use the wheelchair when the back is folded. This alters the centre of gravity and may cause the wheelchair to tip backwards. The back should only be folded for storage or transport of the wheelchair.
- DO NOT hang anything on the back joint that could cause the backrest folding suddenly and may cause injury.

YOU AND YOUR KARMA SERVICE PROVIDER

- No tools are required for assembly. Your wheelchair should be set up by your authorized Karma dealer. Your authorized Karma dealer is also your service provider. Unauthorized repairs, upgrades and add-ons will negate your warranty and may lead to injury. Any adjustments to the rear wheel position should be carried out by your authorized Karma service provider. Your Karma service provider has the necessary service/maintenance manual

- for your wheelchair.
- If you have any defective parts or lose any parts, please contact your dealer for repair and/or replacement. Please only use parts authorized by Karma. Use of parts that are not authorized by Karma will negate your warranty.
 - Customers should go to their dealership for all service needs to guarantee their warranty is not nullified. Always go to an authorized service provider. Unauthorized repairs will nullify your warranty. Procedures other than those described in this manual must be performed by a qualified technician. They also have the service manual with a complete list of maintenance required to keep your Karma wheelchair in top performance. Check the warranty section of this manual to find out what Karma guarantees and what maintenance and parts you will have to pay for.
 - Karma does not have an official list of service providers at this time. Please contact your dealer for service. If you cannot contact your dealer, please contact another authorized Karma dealer for service. If this is not possible please contact us and we will arrange for a service repair. Please note that there will be a charge for collection and delivery of your wheelchair.

CE MARKING

This wheelchair complies with the requirements of the Medical Devices Directive 93/42/EEC.



CAUTION:

Before purchasing and using a Karma wheelchair, please consult a qualified professional to ensure that you choose a suitable product and receive training in how to use it. It may also be necessary to fit additional equipment to your wheelchair or change your wheelchairs set up. Please consult your service provider.

TABLE OF CONTENTS

1. PREFACE2

2. SAFETY3

3. INTENDED USE & PARTS7

4. OPERATION9

4.4.2 METHOD OF RESTRAINT17

6. OPTIONS AND ACCESSARIES22

7. TROUBLESHOOTING23



8. SPECIFICATIONS23

9. CLEANING & RECYCLING24

1. PREFACE

Please carefully read this owner's manual before using the wheelchair. Improper use of the wheelchair could result in harm or injury. Therefore, for safe and enjoyable use of the wheelchair, please read this owner's manual.

- This owner's manual includes operation instructions for the aspects of the wheelchair, unfolding/folding instructions and instructions on how to deal with possible accidents.
- This owner's manual is written for Karma wheelchair: Ergo Lite (KM-2501).
- The symbols used in this manual are explained below. Pay special attention to the parts marked with these symbols.

	WARNING:	Improper use could lead to serious injury or death.
	CAUTION:	Improper use could lead to serious injury and/or damage to your wheelchair.
	SUGGESTION:	Follow these instructions to keep the wheelchair in good condition.

- This manual includes the repair and maintenance chart as well as the warranty.
- If someone else uses the wheelchair, make sure that you give him or her this owner's manual for his or her reference.
- As designs change, some illustrations and pictures in this manual may not correspond to the wheelchair that you purchased. We reserve the right to make design modifications without further notice.

2. SAFETY

2.1 Doorways

The safest way to operate the chair is on level floors that are free of obstacles. Whenever possible use a ramp to enter or exit a facility. Keeping your hands on the push rims will allow you to maintain maximum balance. Do not try to force yourself over an obstruction by propulsion and never use the sides of a doorway to pull yourself through a passageway.

2.2 Leaning

Do not lean over the side of your wheelchair since such an action may cause you to lose balance and fall. (See Figure 2.3)

2.3 Navigating Inclines

- Never turn on a hill due to the danger of tipping.
- When assisting, go straight up a slope. If you need to go down, walk backwards until user is on level ground. (See Figures 2.4 and 2.5)
- Avoid stopping on an incline; it can potentially cause you to lose control of the chair.
- Do not use the brakes to slow down or stop the wheelchair; this could cause it to seize up or pull to one side, causing you to lose control of the wheelchair.
- Whenever possible, navigate inclines with an attendant.
- Operating limits: do not attempt to go up or down slopes greater than 5 degree without assistance.

2.4 Curbs

- Whenever possible get help from an assistant/attendant (if you have assistance make sure that your chair is equipped with push handles).
- Avoid hard impacts when descending a Curb. A hard impact could adversely affect the chair.
- Never try to scale or descend Curbs that exceed a normal height (30-50mm).
- Always be careful when climbing Curbs and never move up or down a Curb in reverse without an assistant.

2.5 Stairs

- Always use two or more assistants. Tilt the wheelchair to its point of equilibrium. One assistant (at the back) holds the wheelchair up against the first step, gripping the handles firmly to lift. The second assistant, holding firmly a fixed part of the front frame, lifts the wheelchair above the stairs and holds it while the first attendant places one foot on the following step and repeat the operation. (See Figure 2.1)
- Never go down steps forwards.
- Never use an escalator for transport, use an elevator.



Figure 2.1

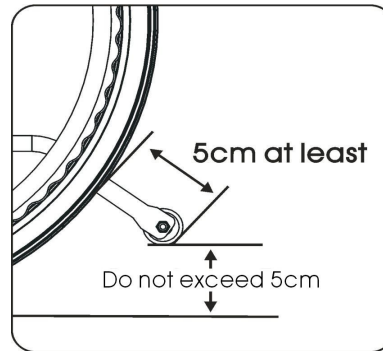

Figure 2.2

2.6 Streets

- Always use extreme caution when crossing streets. Reflective tape on the chair and/or your clothing will make you more visible to drivers.
- Avoid potholes and rough terrain that might cause the casters to become stuck. (See Figure 2.6)

2.7 General

- Always make sure BOTH brakes are applied before getting in or out of the chair.
- Never stand on the footplates when getting in or out of the chair.
- Never carry more than one passenger. Karma wheelchairs are designed for one user.
- Please make sure your clothing does not get caught in the rear wheels.

2.8 Upholstery

- When cleaning the upholstery, use warm water and a mild soap.
- Upholstery cleaner/foam can also be used, but avoid other cleaning solvents.

2.9 Anti-tippers

Please purchase anti-tippers and always use them to avoid personal injury. The distance between anti-tipper and wheels is more than 5cm; the height to floor doesn't be over 5cm. (See Figure 2.2)

2.10 Maximum User Weight Limit

Refer to "Max. User Weight" in section 8. SPECIFICATIONS. Loads exceeding maximum capacity can damage your wheelchair and cause malfunctions yielding a safety hazard. The warranty does not cover damage caused by improper operation of the wheelchair.

2.11 Avoid General Misuse:

- Please note any vehicle can cause injury if used incorrectly. This user guide contains a number of cautions. Please follow these guidelines to increase your safety. Please be aware that careless use endangers your own safety as well as that of others. ALWAYS follow the Highway Code when outdoors and the guidelines written in this manual. Your wheelchair will give years of safe use if used sensibly and carefully.
- Do not let children stand or play on the wheelchair. (See Figure 2.7)



Figure 2.3



Figure 2.4



Figure 2.5



Figure 2.6



Figure 2.7

2.12 Labeling

Please carefully read all the labeling on the wheelchair before using it. Please do not remove them and protect them for future reference.

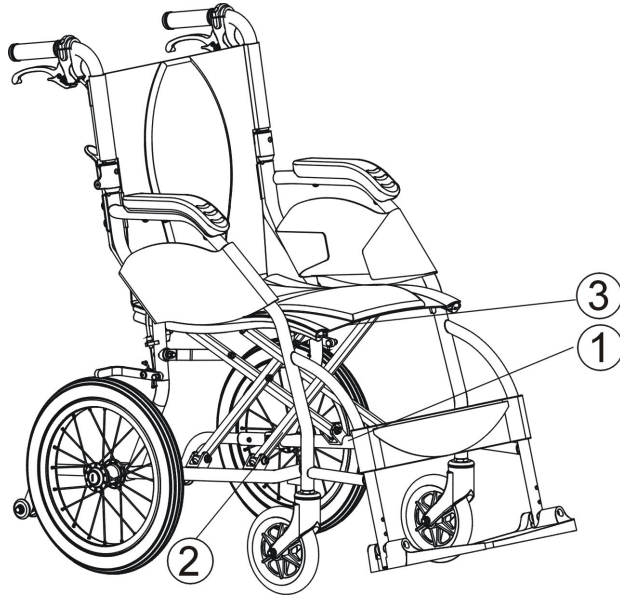

1

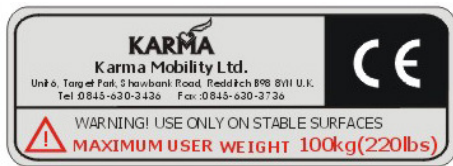

2



3

Model:	
Order No.:	
Delivery Date:	
Sewing No.: <input type="checkbox"/> 1 <input type="checkbox"/> 2 <input type="checkbox"/> 3 <input type="checkbox"/> 4 <input type="checkbox"/> 5 <input type="checkbox"/> 6	
Seat Width	Seat Depth
<input type="checkbox"/> 13	<input type="checkbox"/> 13
<input type="checkbox"/> 14	<input type="checkbox"/> 14
<input type="checkbox"/> 15	<input type="checkbox"/> 15
<input type="checkbox"/> 16	<input type="checkbox"/> 16
<input type="checkbox"/> 17 <input type="checkbox"/> 0	<input type="checkbox"/> 17 <input type="checkbox"/> 0
<input type="checkbox"/> 18 <input type="checkbox"/> 5	<input type="checkbox"/> 18 <input type="checkbox"/> 5
<input type="checkbox"/> 19	<input type="checkbox"/> 19
<input type="checkbox"/> 20	<input type="checkbox"/> 20
<input type="checkbox"/> 21	<input type="checkbox"/> 21
<input type="checkbox"/> 22	<input type="checkbox"/> _____
KARMA	Unit: Inch 108-2009P

3. INTENDED USE & PARTS

3.1 Intended Use

- The Ergo Lite (KM-2501) is a transit wheelchair. That is, it can be propelled by an attendant (transit) only.
- These wheelchairs are suitable for users up to 220.5 lbs in weight. Attendant brakes are provided for both rear wheels.
- It has pneumatic tires for traction and comfort. It also has an extremely durable aluminum alloy frame with tough accessories and does not suffer in dramatic extremes of temperature (neither user nor attendant need touch metal parts in normal use).
- The casters have PU tires for greater durability; pneumatic casters are available on request.
- When prescribing wheelchairs for use by full or partial amputees (above or below knee, single or double) or other conditions that affects the users natural centre of gravity, we suggest contacting your therapist or dealer as well as attaching anti-tippers.

3.2 Parts Description Ergo Lite (KM-2501)

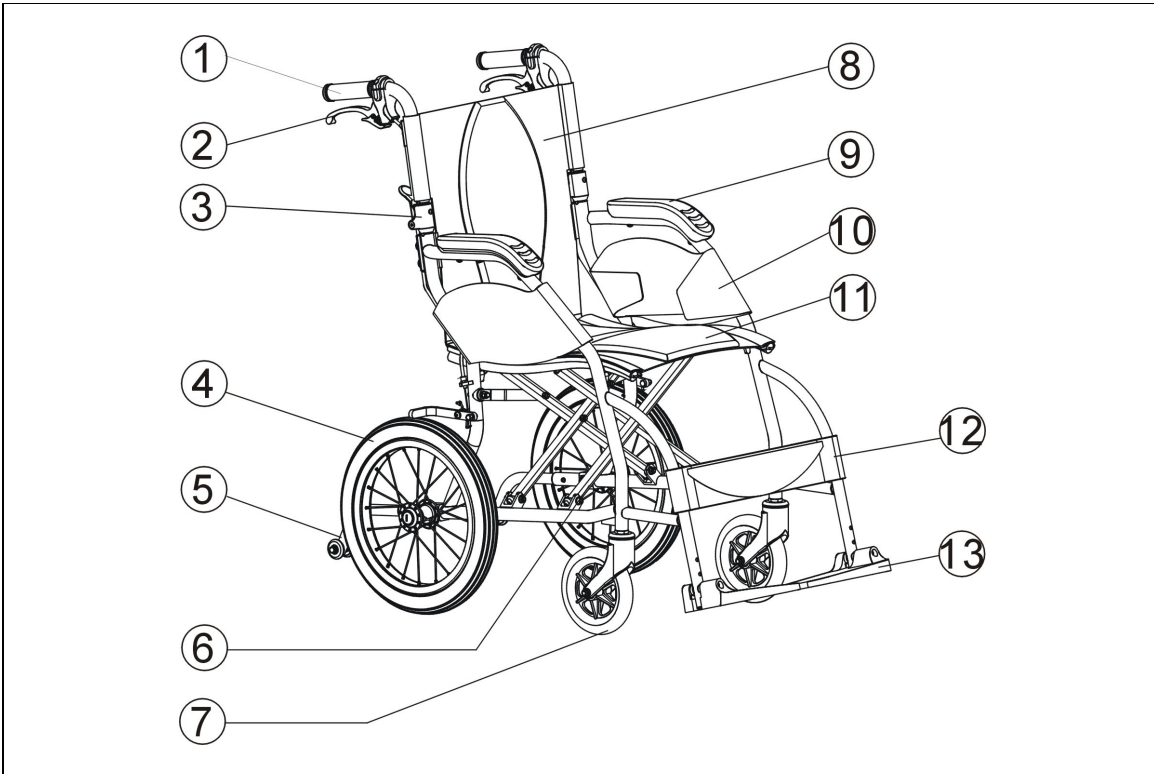

- 1. Push Handle
- 2. Attendant brake
- 3. Back Joint
- 4. Rear Wheel
- 5. Anti-tippers (Option)
- 6. Cross Brace (Cross Bar)
- 7. Caster

- 8. Backrest Upholstery
- 9. Armrest
- 10. Side Panel
- 11. Seat Upholstery
- 12. Calf Strap
- 13. Footplate

4. OPERATION

4.1 Preparing For Use

4.1.1 Unfolding

- Holding the armrests, pull outwards. (See Figure 4.1)
- Pointing your fingers inward with the palm of your hand on the frame, push down until the seat is fully lowered. Make sure the frame is firmly seated in its holder. (See Figure 4.2)
- Flip the footplates down. (See Figure 4.3)
- Ready for action! (See Figure 4.4)

Alternatively, you can stand at the side of the chair and complete step 1 by pulling the nearest armrest towards you and pushing the other one away.



(Figure 4.1)



(Figure 4.2)



(Figure 4.3)



(Figure 4.4)



CAUTION:

When completing step 2 never put your fingers around the sides or under the seat as they can be trapped between the seat and the frame. (See Figure 4.5)

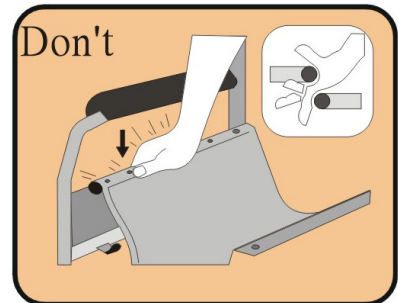

(Figure 4.5)



CAUTION:

Before use please attach the back upholstery to seat .(see Figure 4.6)



(Figure 4.6)

4.1.2 Folding

- Swing up the footplates. (See Figure 4.7)
- Pull up on the seat upholstery by holding it in the centre of its front and back

- edge. (See Figure 4.8)
- Press the two release levers on the backrest frame (push handle tubes) to fold the backrest down for compact storage and easy transport. (See Figure 4.9)
- Folding is now completed. (See Figure 4.10) (Travel bag is optional)



(Figure 4.7)



(Figure 4.8)



(Figure 4.9)



(Figure 4.10)



CAUTION:

Be careful not to get your fingers caught when folding the wheelchair.

4.1.3 Adjustments

4.1.3.1 Rear wheel

Your wheelchair may be supplied with quick-release wheels. If so, please follow the instructions below.

4.1.3.1.1 Rear Wheel Removal

- Support the weight of the chair with one hand by holding the push handle.
- Depress the hub cover and hold down the quick-release mechanism.
- Remove the wheel. (See Figure 4.11)

4.1.3.1.2 Rear Wheel Attachment

- Pick up the wheel: Hold the centre of the rear wheel by grasping two adjacent spokes with four fingers of one hand, use the thumb to depress the quick-release. Take the quick-release axle and depress the button in its centre. This retracts the bearings at the opposite end of the axle. This will allow you to push the axle through the centre of the hub of the wheel. Your wheels are now ready to be assembled to the frame of your wheelchair.
- First ensure that the brake is in the OFF position. Take up the assembled wheel and axle and depress the button in the centre of the axle, as above. This retracts the ball bearings that will allow you to push the axle into the wheel bracket that is located on the lower rear frame of the wheelchair. When you remove your thumb from the button on the axle, the ball bearings should be visible protruding from the axle at the back of the wheel bracket. This will secure the wheel safely in the frame. (See Figure 4.12)



CAUTION:

- You must make sure that the axle is fully located in the wheelchair bracket and that the ball bearings are fully open and have positively attached the wheel in the frame.

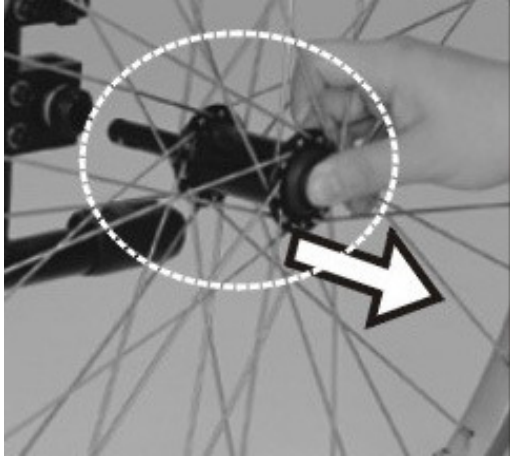

Figure 4.11

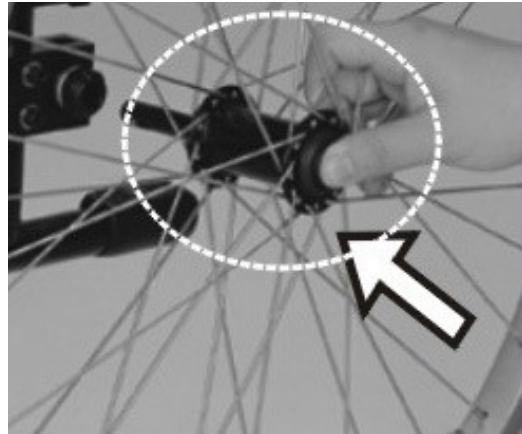

Figure 4.12

4.1.3.1.3 Important Do's and Don'ts

- Do: Keep axles clean and lubricated with light oil or maintenance spray.
- Do: Maintain correct tire pressure if using pneumatic tires.
- Do not: Try to remove the wheels while the wheelchair is occupied even when using anti-tip levers.

4.1.3.2 Footplate Height

- To adjust footplate height use the Karma tool provided to loosen the bolt at the front of the footrest arm. (See Figure 4.13)
- Adjust to required height and re-tighten. (See Figure 4.13)



Figure 4.13



Figure 4.14

i SUGGESTION:

- Make sure that the footplate height is adjusted properly according to the user's calf length to reduce pressure on the body.
- The footrest height must be more than 5cm. (See Figure 4.14)

4.1.4 Transporting and Storing

i SUGGESTION:

Please store the wheelchair in a location where it is out of direct sunlight, rain and dew. For more details, consult your Karma dealer.

**WARNING:**

Don't put anything on the wheelchair while it is in storage. Storing goods on a folded or unfolded wheelchair will cause damage and is not covered under warranty. (See Right Figure)



4.2 Transferring In and Out

4.2.1 Transferring In

- Engage both hand brakes.
- Turn the footplates up and swing them to the side.
- The user lowers himself/herself into the seat using the armrests for support.
- Turn the footplates back down, so that the user can place his feet on them. Ensure that the heels rest against the heel supports to prevent contact with the casters.
- Release both hand brakes.

**CAUTION:**

Always ensure that the front casters are in line with the rear wheels and pointing forwards and that the back of the chair is secure either against a wall or firmly held by an attendant.

4.2.2 Transferring Out

- Make sure that the chair is near your final destination.
- Back the chair sufficiently to ensure that the casters are pointing forward, i.e. in line with the rear wheels and usually with the caster forks pointing forward. Ensure that, where possible, the rear of the chair is against a wall or, if not, it must be firmly held by an attendant.
- Engage both attendant brakes.
- Turn the footplates up.
- Slide forwards on the seat.
- Place one foot firmly on the ground with the knee at a right angle and the other foot slightly apart and further back.
- Place your hands on the front of the armrests and moving your weight forward, bring your head and shoulders up over your knees as you push yourself up.

**CAUTION:**

- Never stand on the footplates when getting into (or out of) the chair. (See Figure 4.15)
- When getting in and out of the wheelchair please use the attendant brakes.
- Please ensure that neither the tread on your tires nor the brake block has become too worn. If pneumatic tires are fitted, please maintain at the recommended tire pressure for the same reason.

When transferring in and out of the chair, make sure that the brakes are applied to prevent the chair from sliding away. Also see that the footplates are flipped up for ease of entering or exiting. (See Figure 4.16)

4.3 General Use

4.3.1 Attendant Pushing

- Ensure that the brakes are always locked when the chair is not being pushed. (See Figure 4.17)
- Always make sure that both feet are safely on the footplates and that clothing is safely tucked out of the way and cannot get caught in the wheels. (See Figure 4.18)
- Always use both hands on the push handles to control the chair. (See Figure 4.19)
- Always avoid steep or uneven surfaces because the chair may tip over. (See Figure 4.20)
- Always avoid soft surfaces because the casters may get bogged down. (See Figure 4.21)
- Always be careful not to go too fast or turn too quickly and try to achieve a smooth steady ride.
- Before crossing the road, please stop completely and look both ways.
- Cross the rail tracks perpendicular to avoid your wheels getting stuck.
- Do not drive at full speed over the railroad tracks.

PLEASE keep in contact with the person in the chair. If you stop to look in shop windows or talk to people, remember to turn the chair so that the person in the chair does not have to turn.

 **WARNING:**
Never lock the brakes too suddenly as this may tip the user out of the chair.



Figure 4.15



Figure 4.16



Figure 4.17



Figure 4.18



Figure 4.19



Figure 4.20



Figure 4.21



Figure 4.22

4.3.2 Tilting by the Attendant

- Make sure both the user's feet are on the footplates and will not slip off. Make sure the handgrips are secure and cannot slip off.
- Release both brakes.
- Grasp both push handles firmly.
- Put your stronger foot on the relevant tipping lever at the back of the chair.
- Tell the person in the chair that you are about to tilt the chair backwards.
- Pull back with both hands and push down and forwards with the foot. This will bring the chair onto the back wheels. (See Figure 4.22)



CAUTION:

- When a chair is tilted to about 25 degrees it will balance on its rear wheels and be easy to hold. If it is tilted further back it will be difficult to hold and the person in the chair will feel unsafe.
- Lower with a straight back; keep your foot on the anti-tipper and lower the chair slowly forwards softly to the ground.

4.3.4 Going Down Curbs

Please note: It is always better to avoid Curbs where possible by using ramped Curbs or slopes and this operation is best attempted with the aid of an attendant.

4.3.4.1 Going Down Curbs Forwards With an Attendant



CAUTION:

- This is the more difficult method and can jar the user but allows a better view of traffic.
- Be careful that the anti-tipper does not get caught on the curb causing the user to fall.

NEVER ALLOW THE CHAIR TO TIP FORWARDS WHEN GOING DOWN A CURB.

- Position the chair so that the front casters are near the edge of the Curb and make sure that the road is clear.
- Move the chair slowly and carefully forwards while tilting it back slightly. Be ready to take the weight when the rear wheels cross the Curb edge. Ensure that both rear wheels touch the ground at the same time to avoid tipping the chair.
- Gently lower the front casters. **AVOID JARRING THE USER.**

4.3.4.2 Going Down Curbs Backwards With an Attendant



CAUTION:

This is the easier and smoother method BUT it requires the attendant to step backwards into the road.

- Back the chair to the Curb edge and be careful that the back wheels are equally near the edge.
- Grasping the push handles, gently lower the rear wheels onto the road. Be prepared to control the weight as it descends and ensure that the back wheels touch ground at the same time.
- Tilt the chair back slightly and pull the tilted chair far enough into the road so that the casters and footrests can be lowered clear of the Curb.

4.3.5 Going Up Curbs

Please note: This operation is best attempted with the aid of an attendant and the best method is to go up Curbs forwards as this maintains the direction of travel and is physically less demanding for the attendant.

4.3.5.1 Going Up Curbs Forwards With an Attendant

- As the footrests nearly touch the Curb tilt the chair. The chair should be tilted just high enough to allow the front casters to roll smoothly onto the pavement.
- Push the chair forward until the rear wheels are touching the Curb. Then, continuing the movement, lift at the push handles while moving the chair forwards.

4.3.5.2 Going Up Curbs Backwards With an Attendant

Please note: for safety's sake we do not recommend using this method.

4.3.6 Up and Down Steps/Stairs

Please note: avoid flights of steps particularly if no extra help is available. Use ramps or lifts wherever possible.

Two attendants are necessary, each capable of carrying at least half of the

combined weight of the person and the wheelchair.
Each helper should bend at the knees and grip the main frame: with the front attendants hands just under the front of the seat, with the back attendant's hands holding the frame just under the push handles.



CAUTION:

Don't attempt to lift the wheelchair by any removable (detachable) parts. Lifting by means of any removable (detachable) parts of wheelchair may result in injury to the user and/or assistant or damage to the wheelchair.

ALL LIFTING SHOULD BE DONE WITH A STRAIGHT BACK.

Straighten legs to lift the chair. Carefully carry it up or down steps; be aware of how you place your feet -- do not cross them and trip yourself up.

4.4 Transportation

The Ergo Lite (KM-2501) has been crash tested to ISO7176-19 (Report No. MBK 09/0964) and is suitable for use in a vehicle that has been adapted for this purpose. The wheelchair must be securely restrained as described in this manual. The Ergo Lite (KM-2501) was tested with a four pint webbing system. For further information on the use of wheelchair restraints please refer to the manufacturer's user guide. Karma always recommends that the user be transferred into car seat with a safety belt or harness while in a transport.



SUGGESTION:

Please transfer to a seat in the car if at all possible

4.4.1 Before use

- Please detach all easily removable accessories from the wheelchair and store them in a safe place where they cannot move around and become a safety hazard.
- A four point tie-down system should tightly fasten the lower wheelchair frame (hook



mark) to the transport vehicle.

- An occupant restraint system using both a pelvis and harness must also be fastened to the transport vehicle to insure user safety. Again, please refer to the restraint system's instructions.
- The attendant / transporter must double-check all fastening points for proper connection and tightness to assure the wheelchair user's safety. The attendant / transporter must be fully aware of the fastening system's usage and its weight limitations.
- See <http://www.unwin-safety.com/> for more information.



CAUTION:

When transporting or lifting, never hold on to attachments or accessories (front/rear wheels, handrims, casters, footrests, armrests, anti-tippers etc.).

All lifting should be done with a straight back. Straight legs to lift the chair. Carefully carry it up or down steps; be aware of how you place your feet, do not cross them and trip yourself up.

4.4.2 Method of restraint

The Ergo Lite (KM-2501) was tested with four point webbing systems. Please refer to the restraint manufacturer's user guide for further details of its operation.

Fitting the front restraint

- Connect the straps around the wheelchair frame and caster bracket as pictured below. The anchor point is marked with a yellow sticker.
- Take the brakes off and reverse the wheelchair to tension the front straps. Apply wheelchair brakes (the brakes should be left on during transport)

Fitting the rear restraint

- Attach rear straps into rail approximately 11.8 in behind the wheelchair backrest.
- Attached the hooks to the rear frame of the wheelchair as pictured below. Tension the restraint until the wheelchair is secure.



Fitting seat belt

- Fasten the 3 point safety belt around the user.
- The occupied wheelchair should be located in a forward-facing configuration, with the parking brake applied.
- Pelvic restraints should make full contact across the front of the body near the junction of the thigh and pelvic as pictured below (correct seat belt position).
- Restraints should not be held away from body by wheelchair components such as armrest or wheels as pictured below (Incorrect seat belt position).

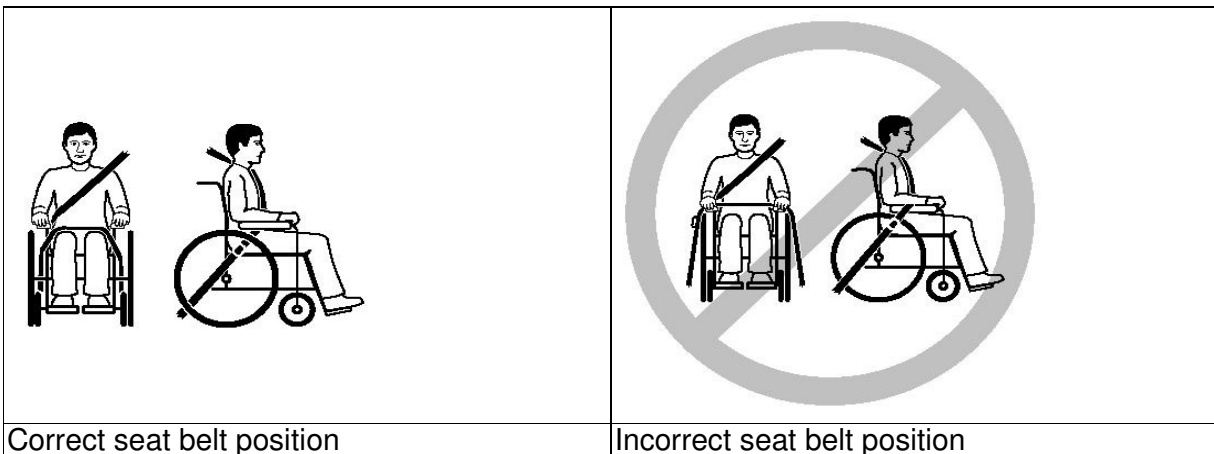

4.5 Safety Belt

How to assemble and disassemble the Safety Belt

- Loosen the fourth and fifth screws of both side of seat upholstery and insert the Safety Belt in between the fourth and fifth screw holes. (Figure 4.23.)
- Keep the safety Belt in 45 deg for comfortable usage. (Figure 4.24.)
- Put the seat upholstery back and tighten screws.

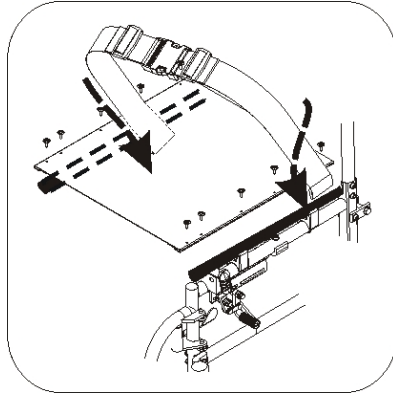

Figure 4.23

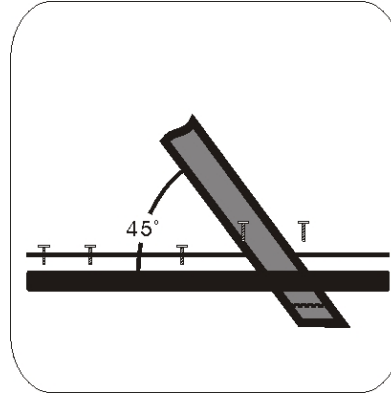

Figure 4.24

Adjusting length of seat belt

- Identify the require length of the belt. (Figure 4.25.)
- Push the two part of belt through buckle to make the belt longer or shorter. (Figure 4.26.)
- Pull the two part of belt tight. (Figure 4.27.)
- Push buckle up to the plastic clip so that the belt cannot slip out of position. Please check that there is no gap between the clip and buckle. (Figure 4.28.)



SUGGESTION:

We recommend that the belt is fitted quite tightly around the pelvis. Please tighten until you can just get your fingers between user and seat belt. Please check that the belt is fastened correctly as recommended. If this is not possible please consult your supplier.



Figure 4.25



Figure 4.26



Figure 4.27

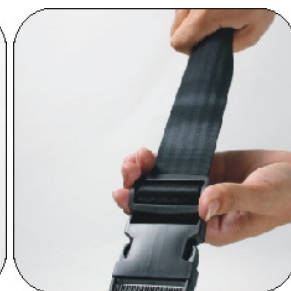

Figure 4.28

How to operate it:

- When you sit on the wheelchair, fasten the safety belt.
- Adjust the belt and make it fit your body for comfort and security.
- When you don't use it, please fasten the belt to avoid the belt dropping into rear wheels during motion.

Maintenance

The Safety Belt is made from 100% polyester fiber and the clasp is made from plastic. It does not require any maintenance but should be inspected every month to ensure that the edges are not frayed and weekly to make sure that it correctly fits the user. If there are any signs of deterioration, please replace it immediately.

5. INSPECTION AND MAINTENANCE

5.1 General Check

Check the following items before travelling. If you find anything abnormal, visit your Karma wheelchair dealer for further inspection before using it.

- Examine brakes, checking for wear, damage and misalignment. Replacing or adjusting the brakes should be carried out by your approved repairer.
- Check that the hand grips are not damaged and are securely bonded to the push handles.
- Check anti-tippers are not damaged and are securely attached.
- Check that the anti-tippers' wheels and frame are not damaged and are securely mounted.
- Before using the wheelchair, make sure all nuts and bolts are tight. Check all parts for damage or wear and have a qualified technician replace it if necessary. Check all parts for proper adjustment.
- Inspect brakes for proper operation.
- The wheels and tires should be checked periodically for cracks and wear, and should be replaced by a qualified technician.
- A qualified technician can be found with an authorized distributor/dealer.



CAUTION:

Visit a Karma wheelchair dealer for inspection and maintenance if you find anything abnormal.

5.2 Regular Maintenance Record

To make sure your wheelchair is in good condition, visit your Karma wheelchair dealer regularly for maintenance (and keep records accordingly) every six months after purchasing.

A maintenance/service fee may apply.



SUGGESTION:

Even if you don't use the vehicle for a long time, the wheelchair should still be maintained annually.

Item	Weekly	Monthly
GENERAL		
● Wheelchair rolls straight (no excessive drag or pull to one side)		V
FRAME AND CROSS BARS		
● Inspect frame structure for small cracks/fissures		V
● Inspect for bent frame or cross bars		V
BRAKES		
● Do not interfere with tires when rolling		V
● Pivot points free of wear and looseness		V
● Easy to engage	V	
● Prevent chair from moving when engaged	V	
SEAT & BACKREST		
● Inspect for rips or sagging	V	
● Inspect for loose or broken hardware		V
CASTERS		
● Inspect the casters for smooth rotation of the caster wheel and caster assembly		V
● Inspect the caster for wear in the bearings/mountings and for tire wear or damage		V
REAR WHEELS		
● Quick-release axles lock properly (if supplied); lubricate if necessary	V	
● No excessive side movement or binding when lifted and spun		V
● Inspect for cracked, bent or broken spokes	V	
ARMRESTS		
● Inspect the detachable armrest button for effective locking		V
● Make sure the armrest detaches and flips back properly		V
● FOOTRESTS		
● Inspect the footplate height adjustment screws are securely tightened		V
● Inspect the swing-away footrest release lever for effective locking		V
TIRES		
● Inspect for flat spots, cracks and wear	V	
● If pneumatic tires, check for proper inflation	V	
● Check tire tread depth is more than 1mm		V
● Check tire pressure; tire pressures are located on the side of the tire	V	



CAUTION:

As with any wheelchair, the wheels and tires should be checked periodically for cracks and wear, and should be replaced. Failure to keep tires at the correct pressure will reduce the braking efficiency.



CAUTION:

Never disassemble or modify the wheelchair frame structure. Otherwise, injury or damage may occur. This will negate the warranty.

6. OPTIONS AND ACCESSORIES



- I.V. Pole
- Height adjusts from 130cm (51") to 200cm (78").
- Attaches to all Karma manual wheelchairs.



- Backrest Bag
- Standard size.
- Attaches to all Karma manual wheelchairs.

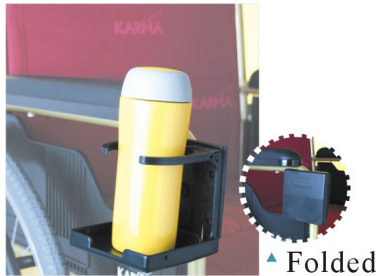

- Folding Drink Holder
- Collapses and adjusts to the size of the container (6-10cm).
- Attaches to all Karma manual wheelchairs.



- Anti-tippers
- Attaches to all Karma manual wheelchairs.



- Multi-purpose Safety Belt
- Attaches to all Karma manual wheelchairs.



CAUTION:

Attaching accessories may alter the overall stability and centre-of-gravity of the chair. Thus, this should be performed by your approved repairer and therapist.

7. TROUBLESHOOTING

Trouble or Problems with Your Wheelchair

You can inspect the following before taking your wheelchair to a Karma wheelchair dealer.

Problem	Checking Points and Corrective Action
Chair Veers Right/Left	<ul style="list-style-type: none"> • Check tires for correct and equal pressure • Check caster bracket angle • Check that rear wheels are equally spaced from the seat frame
2. Sluggish Turn or Performance	<ul style="list-style-type: none"> • Check tires for correct and equal pressure • Check for loose nuts and bolts
3. Caster Flutter/Wobble	<ul style="list-style-type: none"> • Check tires for correct and equal pressure • Check for loose nuts and bolts • Check caster bracket angle
4. Squeaks and Rattles	<ul style="list-style-type: none"> • Check for loose nuts and bolts
5. Looseness in Chair	<ul style="list-style-type: none"> • Check for loose nuts and bolts

If you cannot solve the problem by yourself, contact your Karma wheelchair dealer for help.

8. SPECIFICATIONS

Model	Ergo-Lite(KM-2501)	
Overall Length (in)	37	37
Overall Width (in)	22.4	24.5
Overall Height (in)	35.8	
Total Weight (lb)(pneumatic rear tire)	18.3	18.5
Seat Width (in)	16"	18"
Seat Depth (in)	16.5	
Seat Height (in)	19	
Backrest Height (in)	16.5	
Armrest Height (in)	8.5	
Calf Length (in)	13.8 - 15.7	
Overall Collapsed Length (in)	33.5	
Overall Collapsed Width (in)	10.8	
Overall Collapsed Height (in)	28	
Maximum User Weight (lb)	220.5	220.5



CAUTION:

Please don't travel across a slope (in any direction) greater than 7 degrees.

Stability (According to ISO 7176-1:1999)	
Dummy 220.5 lb	Ergo Lite(KM-2501)
Forward	16°
Backward Rear Wheels Locked	10.5°
Backward Rear Wheels Unlocked	15°
Anti-tip	11.5°
Sideways	16°

9. CLEANING & RECYCLING

9.1 CLEANING

In order to lengthen the life of your wheelchair, it is suggested that you clean the wheelchair periodically (if not daily), especially after it is used in the rain or snow. We recommend that you don't use your wheelchair in the rain or snow. If you are travelling and get caught in the rain, we suggest you try to find shelter. If you can't find shelter, proceed to your destination.

9.1.1 Frame

Wipe with a damp cloth.

9.1.2 Upholstery

- When cleaning the upholstery, use warm water and a mild soap.
- Upholstery cleaner/foam can also be used, but avoid other cleaning solvents.

9.2 POST-CONSUMER RECYCLING

A post-consumer recycling plan should follow the Environmental Protection Administration's regulations. The items listed below are for reference only as local laws and regulations may vary.

Material	Part Name	Method
Aluminum-alloy	Frame	Recyclable
Plastic	Modular Components	Recyclable
Paper	Owner's Manual	Recyclable

- There are many organizations in many countries you can find on the Internet that will accept used goods for charity. Please search the information highway to help less fortunate individuals and protect our planet for future generations. If you do not have access to the world wide web please use your local phone directory, ask for operator assistance or go to your local government centre for more information. Earth Day is every day.
- Check with your local recycling centre on where and how to recycle your wheelchair as this information varies from region to region.

10. WARRANTY

10.1 Serial Number

To ensure after-sale service and warranty, please record and fill in the serial number which can be found on the frame.

Model	
Serial Number	

10.2 U.S.A. Limited Warranty Policy

Karman warrants the main frame of S-ERGO 105, 106, 115, 305, 2501 KM-3520, KM-802, KM-5000, KM-7501, KM-8020, VIP515, MVP-502 series against defects in material and workmanship for the lifetime from the date of purchase, 6 months on parts.

Karman warrants the main frame of KM-9020L, KM-TV10, KM-AA10, KM-AA20 against defects in material and workmanship for one year from the date of purchase, 6 months on parts.

This warranty is extended only to original purchasers of our products. Warranty is not transferable. Parts or materials which are subject to normal wear and which must be replaced/repared are the owner's responsibility and are not covered by

warranty. Arm pads and upholsteries are not covered by warranty. It is recommended that wheelchair be returned to the authorized dealer through whom it was original purchased.

If within such warranty period, any such product is proven to Karman's satisfaction to be defective; such product shall be repaired or replaced at Karman option. In no case are goods to be returned without first obtaining an R.M.A. (Returned Merchandise Authorization) number issued by Karman and that the part in question is returned insured with freight prepaid to Karman, within the period of warranty. Labor charge incurred in the installation or repair of the above-mentioned parts plus all freight charges are not included in the warranty.

If Karman does not have a completed Warranty Registration Card on file for the consumer's product, then a copy of the invoice with date of purchase must be provided. The warranty period for the consumer commences on the purchase date from the seller. The warranty period for the seller, if the products are not to be sold to a consumer, commences on the invoice date from Karman Healthcare. The warranty is void on wheelchairs that have had the serial # tag removed or altered.

Products which have been subject to negligence, abuse, improper storage or handling, improper operation, unauthorized modifications or misuse are not covered by this warranty. Karman Healthcare will not warrant the frame or any parts damaged when the maximum weight limit is exceeded. Warranty applies in the U.S. only.

Karman Healthcare's sole liability extends to repair or replacement of parts or components as previously specified. The foregoing is in lieu of all warranties expressed, implied or statutory, whether written or oral.



KARMA: Leading the way, all the way.

Established in 1987, KARMA is an energetic brand which designs, manufactures, and markets a full range of mobile disability products for worldwide markets. KARMA owns a strong in-house R&D team committed to providing the best product designs for our business partners. Our impeccable quality control allows KARMA to be an ISO 9001 certified company. We have also surpassed the quality requirements for several different countries obtaining certification for CE, RoHS, REACH, FDA, and ASU.

Nowadays, senior citizens and people with physical limitations from more than 30 countries can easily obtain KARMA's high quality products and service, including the UK, Germany, Denmark, Spain, U.S.A., Australia, New Zealand, Japan, Korea, and Taiwan to name just a few.

In each of these countries, KARMA has achieved a very good market position with great reputation. Together with its partners, KARMA continues to push forward, offering innovative life enhancement products that enable people to enjoy more active and rewarding lifestyles.



NATIONAL AGENT:

SOLD AND SERVICED BY:

Karma reserves the right to modify information herein without further notice

Filename: KM-2501Manual
Directory: C:\Users\David\Documents
Template: C:\Users\David\AppData\Roaming\Microsoft\Templates\
Normal.dotm
Title: 型號 : KP-4 系列使用手冊(KP-40,KP-45)
Subject:
Author: Guest
Keywords:
Comments:
Creation Date: 1/15/2010 1:45:00 PM
Change Number: 8
Last Saved On: 8/2/2012 3:48:00 PM
Last Saved By: SALES-M
Total Editing Time:58 Minutes
Last Printed On: 6/20/2013 4:43:00 PM
As of Last Complete Printing
Number of Pages: 30
Number of Words: 5,643 (approx.)
Number of Characters: 32,171 (approx.)