

# EZRide+™

## INSTRUCTIONS



**READ  
THIS  
BEFORE  
USING**

**EZRide+**  
PATENT PENDING

**Read Instruction Manual Completely Before Using EZ Ride**

**Multi-tool  
Included**



**After multiple uses of EZRide+, use multi-tool to tighten all bolts, nuts, and screws on the unit and tow bar.**

**EZRide+**  
PATENT PENDING

Copyright 2022 Shield Innovations LLC

## TABLE OF CONTENTS

Warnings.....	Page 2
Tow Bar Parts.....	Page 3
Tow Bar Installation - Chair Clip.....	Page 4
Tow Bar Installation - Slide Tube.....	Page 5
Tow Bar Un-Install.....	Page 6
Tow Bar Hitch Height Adjustment.....	Page 7
Kickstand Installation.....	Page 8
Hitch Handle & Kickstand Installation.....	Page 9
EZ Ride-Wheelchair Connection.....	Page 10
EZ Ride-Wheelchair Release.....	Page 11
Speedometer & Handle Controls.....	Page 12
Handle Fold Instructions.....	Page 13
Handle Bar Reversal Instructions.....	Page 14
	Page 15
Adjustable Neck Installation.....	Page 16
	Page 17
Tow Bar Extension Installation.....	Page 18
	Page 19
How To Charge.....	Page 20
Battery Charger Travel Bag.....	Page 21
EZ Ride Safety Tag.....	Page 22



# WARNING!

Carefully read this manual regarding EZ Ride. EZ Ride is not a toy. Use caution when attached to your wheel chair.

THE MANUFACTURER DISCALIMS ALL LIABILITY RELATING TO DAMAGE CAUSED BY:

- The failure to abide by the instructions in this manual and its instructions.
- EZ Ride being used in ways which is not the intended use.
- EZ Ride being used in ways contrary to applicable laws on safety.
- Tampering with parts that operate the EZ Ride in an efficient manner.
- Incorrect assembly.
- Changes made to EZ Ride function and design without permission of the manufacturer.
- Use of non-original parts or parts that are not suitable for the EZ Ride.
- Repairs not performed by a qualified technician.

## WARNING

**MAX SPEED: 12mph**  
**WEIGHT LIMIT: 300lbs**  
**FOR WHEELCHAIR USE ONLY. NOT A TOY.**

## CAUTION

**NO SHARP TURNS AT MEDIUM OR HIGH SPEEDS!**



**NOT FOR USE IN SAND**

**LOW TO MEDIUM SPEED IN ROUGH TERRAIN**



**BATTERY MUST NOT BE CLOSE TO EXTREME HEAT OR COLD.**

**MAX 140°F**  
**MIN -4°F**

Patent Pending



## WARNING

**LI-ION 36V == 350 Wh 10.0 Ah**  
**Battery / Pile / Bateria 130501002DG9**

To reduce the risk of injury, user must read Operator's Manual. Risk of fire and burns. Do not expose battery to Rain, Water, or Liquids, Open, Crush, Heat Above 140°F, Incinerate or Short Terminals. Follow Manufacturer's Instructions. Use only with charger listed in Operators Manual.

Remove Battery from unit when storing for long periods of time, changing attachments, or making adjustments.

# TOW BAR PARTS

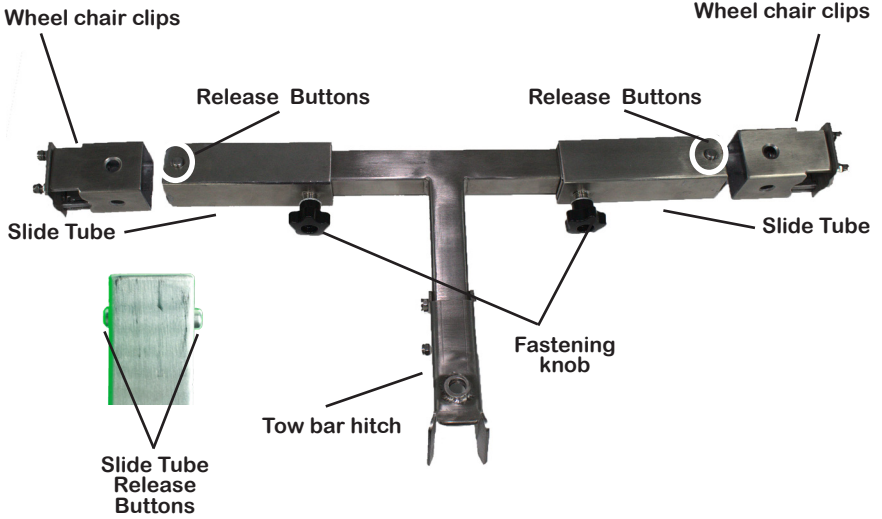

# CHAIR CLIP BREAKDOWN

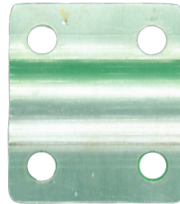

# HITCH BREAKDOWN

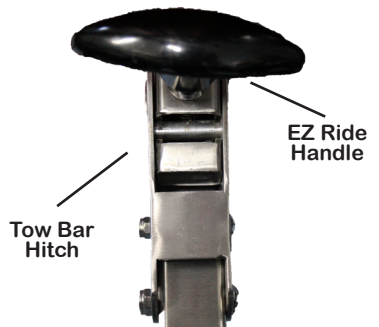
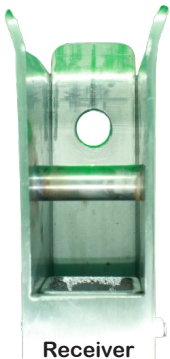

## TOW BAR INSTALLATION

### *Chair Clip*



Place chair clip around horizontal or vertical wheel chair bar. Close to front of chair with screws facing outward.



Place chair clip cover over bar. Confirm it matches the curvature of the bar.

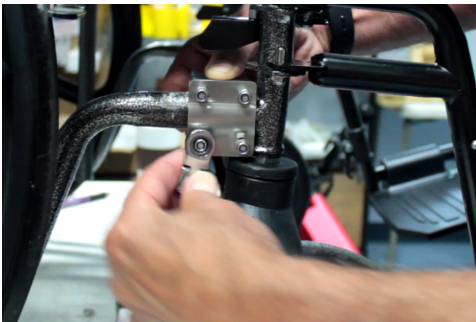

Screw small nut first until it meets the cover, do not tighten. Then place second lock nut on screw. **Do not tighten** completely.



Repeat on other side of chair. Make sure left and right clip are in the same position on the bar. Adjust clips to make as level as possible

## TOW BAR INSTALLATION

### *Slide Tube*

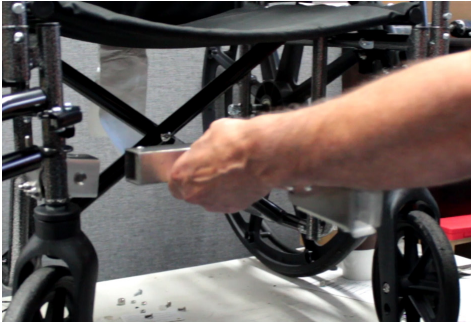

Make sure the chair is in the expanded position. The tow bar is spring loaded. Compress the slider tubes and line up with the chair clips.

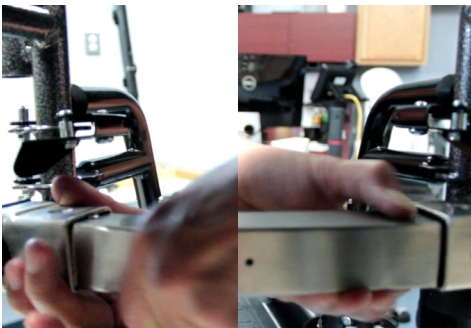

Squeeze both the top and the bottom release buttons and push the slide tube into the chair clip until the release buttons pop through the chair clip hole. Do on both sides.



Move the tow bar hitch until it is centered between the two foot pads. Then tighten the 2 chair clips making sure the tow bar is level.



Tighten the 2 fastening knobs. It is normal for the tow bar to have some slight movement.

## TOW BAR UN-INSTALL

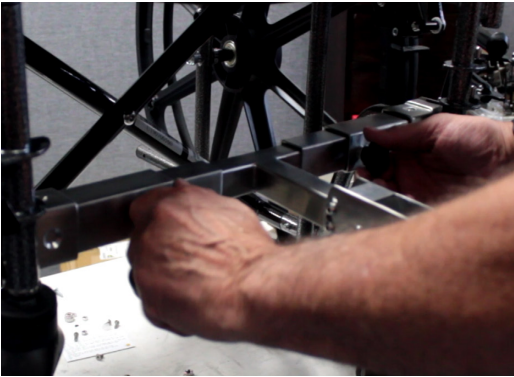

Loosen both fastening knobs.

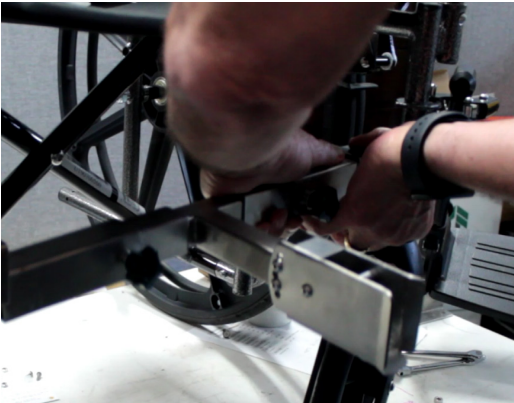

With one hand squeeze the chair clip release buttons and pull the slide tube toward the center until it releases from the chair clip.

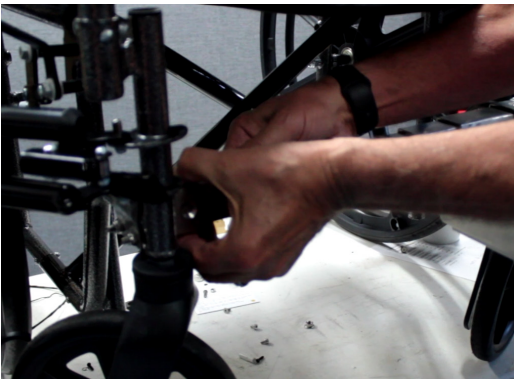

Do the same on the other side. When both are released push both slide tubes to the center of the tow bar then remove from clips and tighten fastening knobs.

## TOW BAR HITCH HEIGHT ADJUSTMENT



Normal position for EZ Ride tow bar hitch.



Raise tow bar hitch to raise front wheels of the chair higher off the ground.



Lower tow bar hitch to lower front wheels closer to the ground.

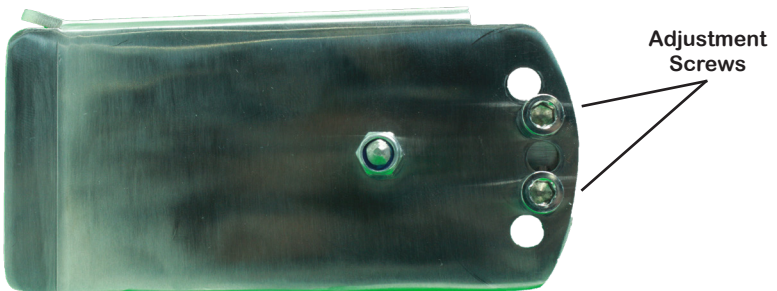



## KICKSTAND INSTALLATION



To install kick stand insert kick stand over the plate with the two screws.

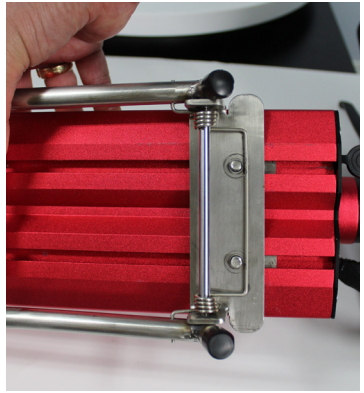

Make sure kick stand is straight along back side of EZ Ride.

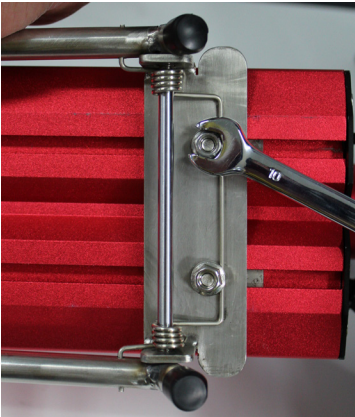

Install two screw nuts and tighten with wrench.

Kickstand



# HITCH HANDLE & KICKSTAND INSTALLATION



Position of the hitch handle assembly is NOT CORRECT.



**CORRECT** position for hitch handle, aligned even with white lines at top.



If adjustment needed, loosen Allen screws to move hitch handle assembly.

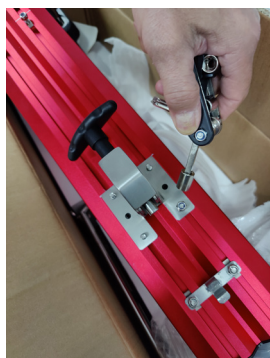

Once hitch handle is positioned, tighten using multi-tool.



Align kickstand screw inserts with white guide lines.



Tighten with multi-tool.

## EZRIDE-WHEELCHAIR CONNECTION

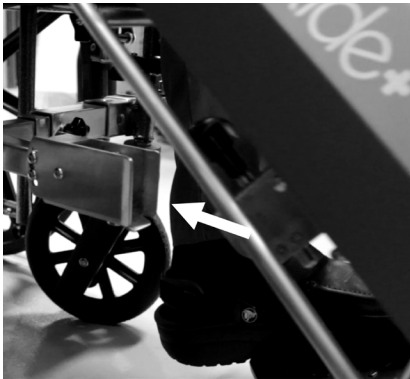

While sitting in chair, using steering handle pull EZ ride towards tow bar hitch. Kickstand will automatically close.

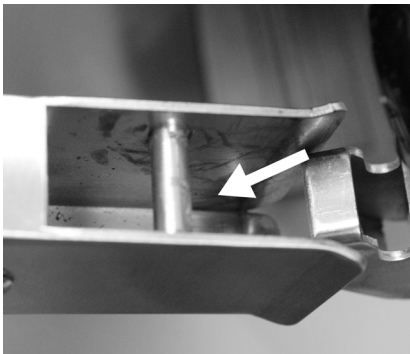

Line up EZ Ride handle inside hitch receiver so handle is inserted **under** receiver rod .

Receiver Rod

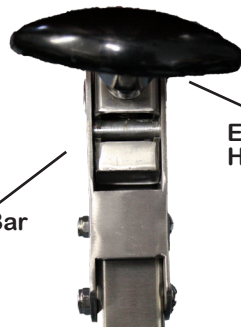
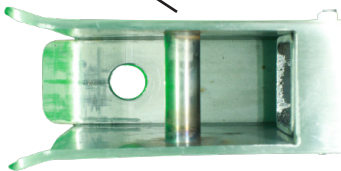

EZ Ride Handle

Tow Bar Hitch



Pull EZ ride towards you and once handle is under rod push up to engage tow bar hitch. Once locked in confirm front wheels are off the ground by at least 2-3". If not, adjust Towbar Hitch height. *see page 7*

## EZRIDE-WHEELCHAIR RELEASE



To release EZ ride from Tow Bar push up on steering handle and at the same time lift EZ Ride handle up.



Holding on to EZ ride handle and steering bar Push down and forward to release EZ Ride from Tow Bar Hitch. Push EZ ride away from Chair to clear footrests.



Pull kickstand away from EZ Ride to the extended position. Insure it is flush to the ground. Make sure EZ Ride is on level ground when extending Kickstand.

# SPEEDOMETER & HANDLE CONTROLS

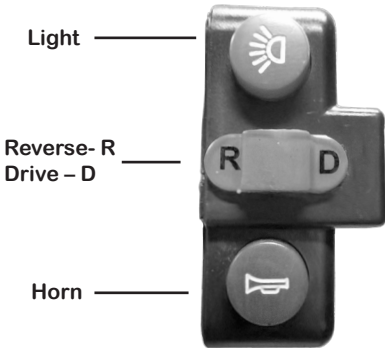

Display functions:  
Speed display, Battery level,  
Total mileage, Cumulative  
mileage, currnet speed

Short presses to  
change speed

Press and hold to  
power on

Note: Some  
models will not  
have light function

Press to see  
mileage/Voltage/  
Trip. When trip is  
showing press M  
button two times to  
record mileage



**ECO** *Throttle Controls*  
Speed 3 mph- this gear is designed to allow user to cruise alongside a person walking as well as indoor use.  
*Note: Pressing throttle to start ECO speed has 3-second safety delay before starting.*

**MID** Speed 6 mph- this gear is a moderate speed for outdoor use , do not make any sharp turns.

**HIGH** Speed 12 mph- **CAUTION.** This gear is fast . Use only on smooth surfaces in open conditions. **DO NOT MAKE ANY SHARP TURNS IN THIS SPEED.**

*How to set cruise control.*

- 1) Hold throttle on desired speed for 5 seconds. This will set the cruise control for that speed.
- 2) To release cruise control apply brake or push throttle.

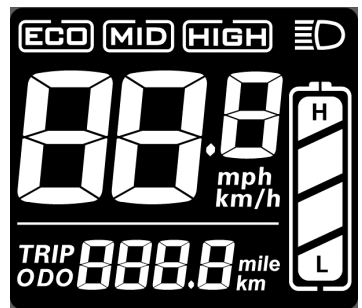

## HANDLE FOLD INSTRUCTIONS



To fold handle to down position grab round release ring and pull towards handle grip.

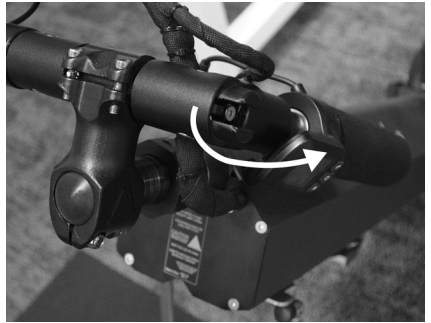
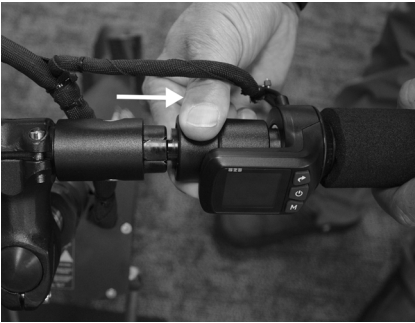

Once release ring extended push handle to down position

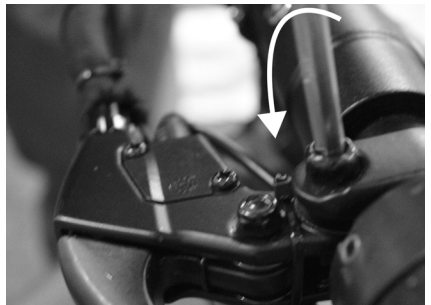
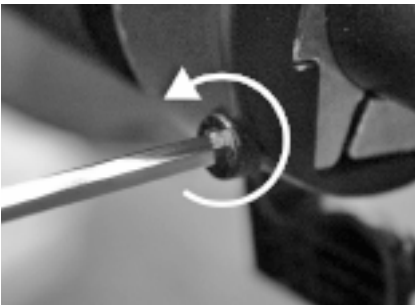

To adjust angle of Brake or Speedometer turn Allen screw counter clockwise to loosen. Adjust to position desired and tighten Allen screw

## HANDLE BAR REVERSAL INSTRUCTIONS

First, take off the front bracket by removing the four 4mm hex screws and rest the handle bars beside EZ-Ride.

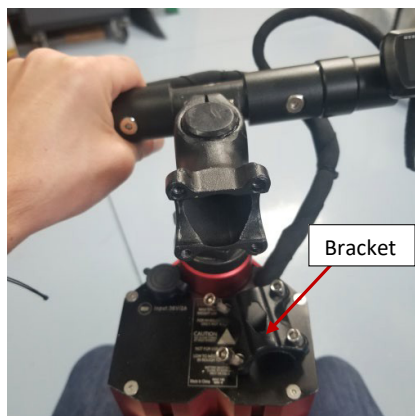
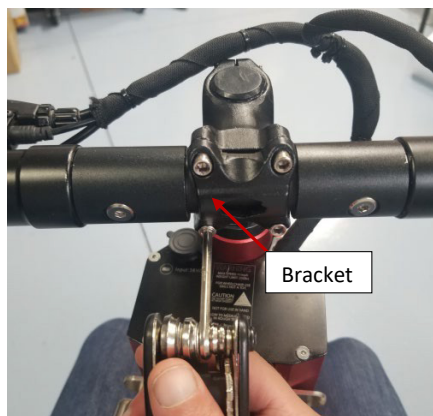

Then loosen the two screws that clamp the handle bar stem to the steering column using a 5mm hex key. Only loosen the stem until it is able to rotate.



## HANDLE BAR REVERSAL INSTRUCTIONS

Rotate the stem 180 degrees and looking down from the top of the EZ-Ride and line up the stem with the drive wheel. Once both are lined up properly, tighten the stem down switching between the two screws so they are both tightened down evenly.

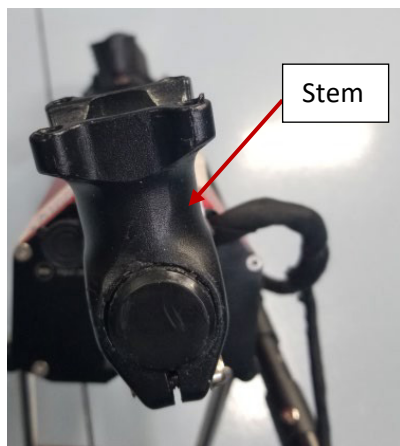

Place the handle bars back on along with the bracket and start by hand tightening the four screws to get the threads started. Then tighten the screws in a pattern using the multitool so all screws will be tightened down evenly.





## ADJUSTABLE NECK INSTALLATION

1. First, take off the front bracket by removing the four (4) 4mm hex screws and rest the handle bars beside the EZRide.

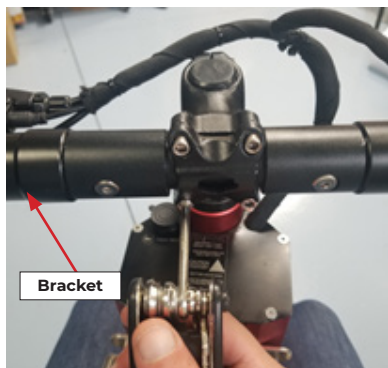

2. Then loosen the two screws that clamp the handle bar stem to the steering column using a 5mm hex key, until the standard EZRide handle bar neck can be removed.



3. Place the new adjustable neck on the steering column as shown at right and tighten until it's securely in place.



## ADJUSTABLE NECK INSTALLATION

4. Attach the handle bars to the adjustable neck by removing the four (4) hex screws and placing the handle bars as shown, and tighten until the handle bars are secure.



5. Adjust the neck angle by loosening the hex screw at the hinge, then tighten at the desired angle.



## TOW BAR EXTENSION INSTALLATION

1. Use the included multi-tool and a wrench to loosen, and remove the 3 screws attaching the hitch to the tow bar.



2. Slide the hitch off the tow bar.

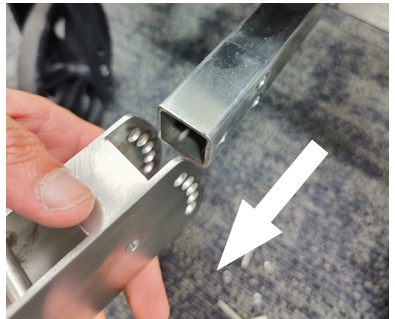

3. Slide the tow bar extension accessory onto the tow bar. Determine how far you want the EZRide to sit from the wheelchair - 3 or 6 inches.

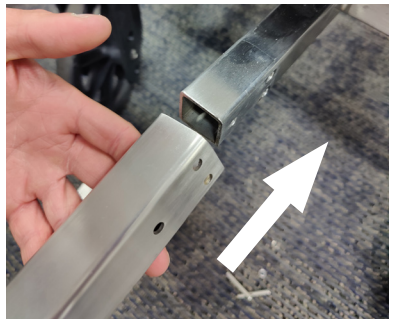

4. Align the screw holes to the desired extension.

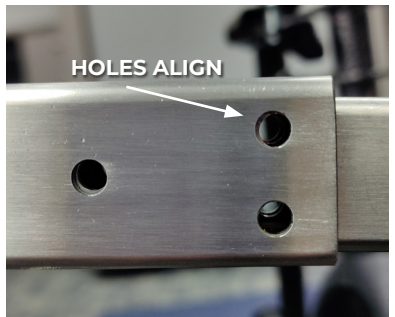

## TOW BAR EXTENSION INSTALLATION

5. Insert the 3 screws. Finger-tighten the nuts. Then, using the multi-tool and a wrench, tighten the screws to secure.



6. Slide the hitch on to the end of the tow bar extension, insert the centermost screw and finger-tighten.

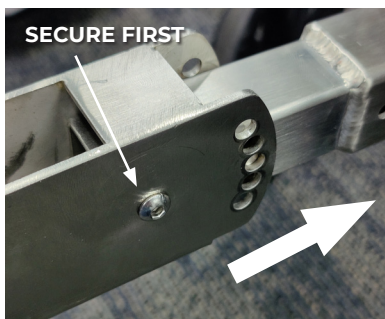

7. Adjust the angle by tilting the hitch until the proper screw holes match. Then insert the remaining 2 screws. Tighten and secure all 3 screws.

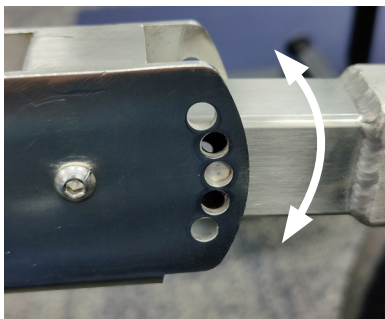

8. This final installation image shows the tow bar extension set for 6 inch distance.



## HOW TO CHARGE



EZ Ride Male Port

Electrical Outlets Plug

Align groove and notch to plug in

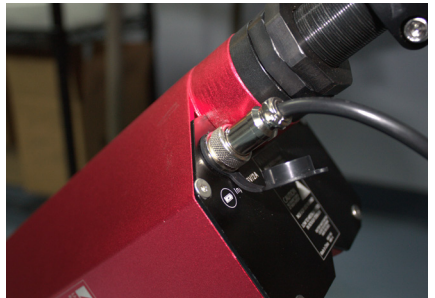
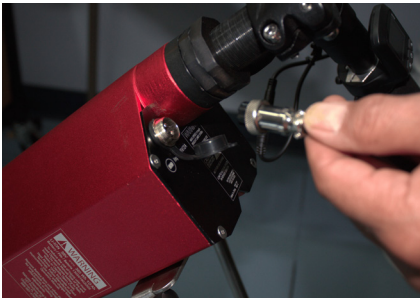
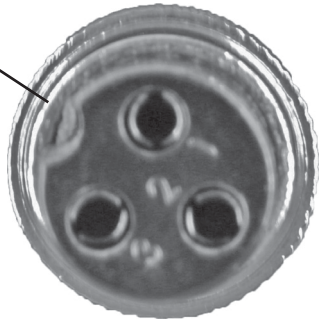
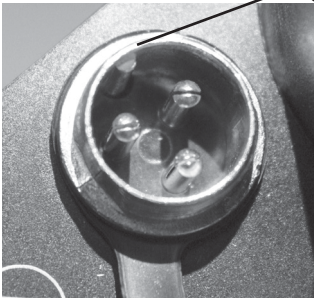

Insert three prong charging cable into port on top of EZ Ride.

Plug into normal 110 outlet.

Keep plugged in until light on charger turns green.

Best to charge after each use.

**Note: Like a car EZ Ride will lose charge over time if not used on a regular basis . Check battery before using EZ Ride**

## BATTERY CHARGER TRAVEL BAG



Battery charger bag can be used for back of wheelchair mounting or clips can be joined together for hanging or shoulder use.







# READ THIS BEFORE USING EZ Ride+™

PATENT PENDING

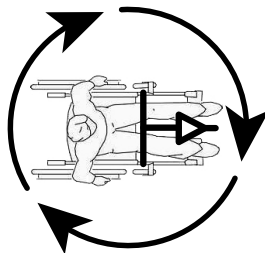

## Read Instruction Manual Completely Before Using EZ Ride

-  **DO NOT use medium or high speed indoors. Use eco speed only.**
-  **DO NOT make a 360 degree turn using medium or high speed.**

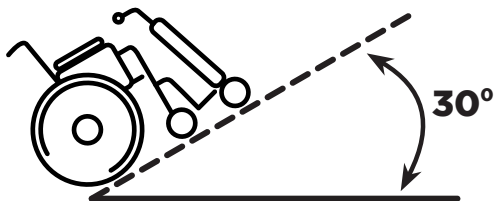

-  **DO NOT use EZ Ride on an incline of more than 30 degrees.**



-  **DO NOT use high speed until you are comfortable with eco & medium speed.**
-  **DO NOT use EZ Ride in sand or loose gravel.**