

GRAND DIVE VERTICAL



WHAT IS INCLUDED



Chamber

Carry Bag

Frame

Carpet

Floor

Bluetooth Stereo

2 Compressors

Zipper lubricant & cleaner

Auxiliary Valve

SET UP



The first step is to fold back the chamber to expose the bottom pocket for the floor. You will need to unzip this pocket so that you can place your floor in the center of this circle.

SET UP



Carefully place the wooden floor in the center of this pocket opening. The floor will be a little smaller than the bottom circle. It is very important that you center the wood floor. When you inflate your chamber and it does not seem to be balanced, you may need to readjust the floor to make sure it is in the center of the circle.

BUILDING THE FRAME

Top ring

3 Poles



3 Telescoping poles
(pole inside a pole)

BUILDING THE FRAME

It is best to build the frame inside the chamber after it inflated.

Connect the bottom ring by removing the small screw and connect the two ends together. Once the ends are connected reinstall the screw tightening it all the way.



SET UP

By now you should have the floor zipped into the bottom pocket.

Next you will place the carpet inside the deflated chamber.

Someone will need to enter the chamber with the 3 poles and two rings.
The person on the outside will follow the next inflation steps.

You only need to bring the chamber to shape to build the
frame, not to full pressure.

Make sure the compressors are running during this procedure

BUILDING THE FRAME



You will need to put the two rings and 3 poles into the deflated chamber.

Once the chamber is inflated it will be easier to build the frame.

You will connect the three poles to the two rings. There is only one way that the poles will connect into the rings.

The frame inside the chamber should look like this.

BUILDING THE FRAME



NOTE:

You will notice that the large bottom ring will need to be attached.



Remove the small screw and push the two ends together.

Once they are securely connected install and tighten the screw.

STEREO

Bluetooth Stereo



A bluetooth speaker is included for your enjoyment.
Simply follow the instructions inside the bluetooth box.

INFLATING

CAUTION

At first, follow these instructions to inflate and deflate the chamber without any person inside the chamber.

WARNING

Never take a treatment alone.

Always have someone outside the chamber to assist you.

INFLATING



First, turn the red knob so that the marks line up together.
This will prevent air escaping.

INFLATING



Next it is time to close the zippers. There are two zippers that stretch nearly the length of the chamber. These zippers are dual-triggered and can be opened and closed from inside or outside the chamber.

INFLATING



If you are closing from the outside, pull the black T connected to the inside zipper

INFLATING



It is important that the inside zipper is totally closed into the dock.

INFLATING



Pictured is the right and wrong way to close the inside zipper.

INFLATING



Next close the outside zipper. Hold the loop to start pulling the zipper.

INFLATING

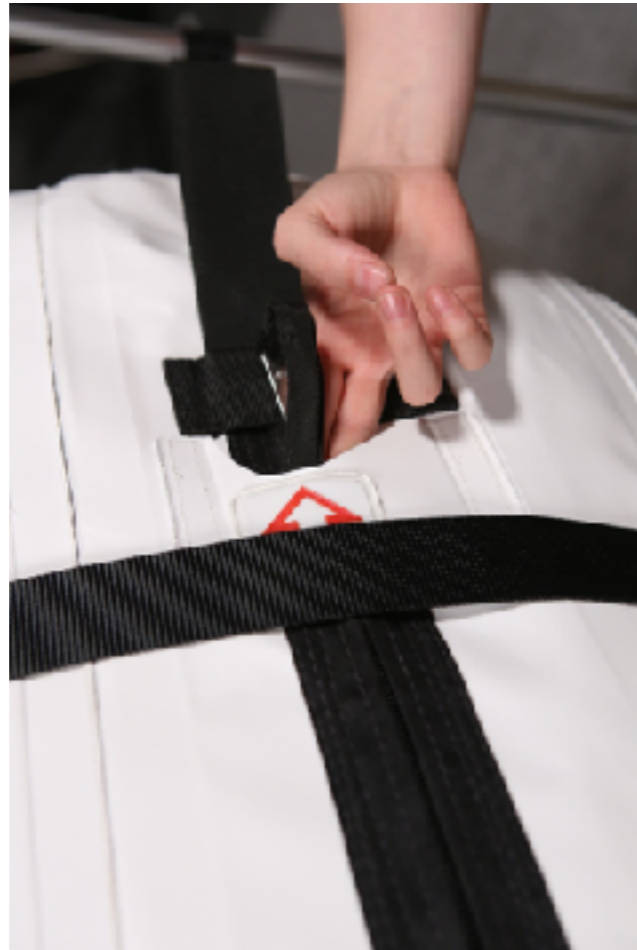

Be sure that the zipper pull is tucked under the arrow and is all the way closed.

red

INFLATING

CAUTION

Make sure both the inside and the outside zippers are **completely closed** each time the chamber is in use. Failure to do this may result in damage to the chamber.

INFLATING



Next buckle the belts.

INFLATING

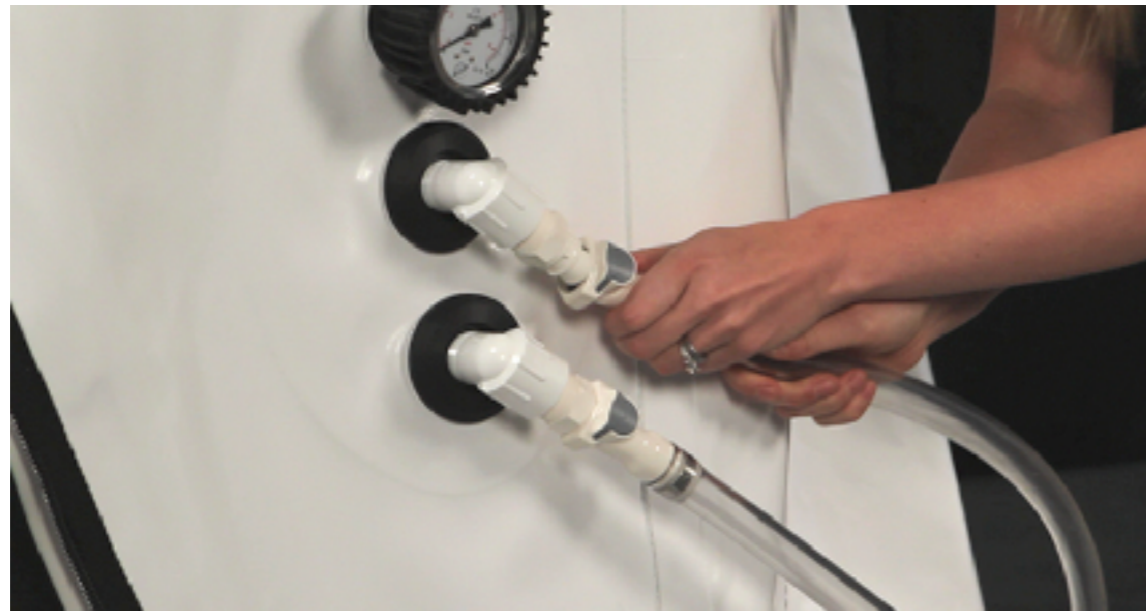

Now it is time to connect the compressor hoses to the chamber. snap the hoses to the fill valve until you hear a click.
compressors into an electric outlet.

Simply
Next plug the

INFLATING



You will notice that there are two relief valves on your chamber.

The

blue valve is factory set to release air when the chamber reaches 1.3 ATA.
The yellow valve is set at a slightly higher pressure for redundancy and safety.

INFLATING

CAUTION

If the relief valve **does not release** air when it is at full pressure,
your treatment and call your distributor.

stop

The compressor must **remain on for the entire treatment** session to ensure the circulation and exchange of fresh air, which provides a safe and comfortable treatment.

INFLATING



Notice that the gauge is reading zero when you begin.
then reach the blue section on the gauge which is 1.3 ATA.
hear air being released from the blue valve.

It will
You will

INFLATING



The Grand Dive Vertical chamber is unique in that it also has an internal gauge that can be read from inside the chamber. You will notice that the gauge needle moves counter clockwise while inflating the chamber. The inside gauge allows you to monitor the pressurization to determine when you have reached 1.3 ATA. During depressurization this allows you to determine when it is time to open the zipper.

INFLATING

INFLATING THE CHAMBER WHEN INSIDE

If you will be inflating the chamber from the inside of the chamber
follow these instructions:

please

Plug the compressor into an electric outlet and ensure it is running

Make sure the red knob is closed

Step into the chamber

Buckle the belts

Close the outside zipper

Close the inside zipper

DURING TREATMENT

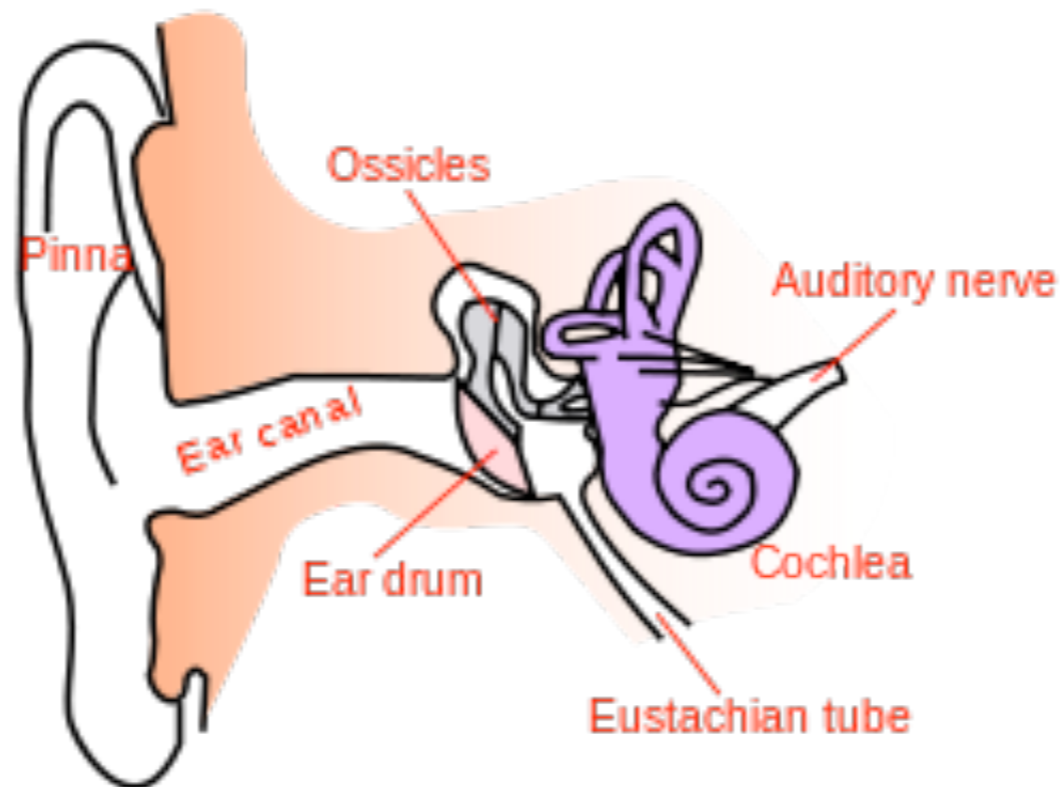

As the chamber begins to inflate, you may notice added pressure on the ears.

This feeling indicates the need to equalize the pressure.

The pressure feeling is similar to that of landing in an airplane.

This pressure is relieved through the Eustachian tube.

There are several methods for relieving this pressure.

DURING TREATMENT

The first, is the Valsalva maneuver. Pinch your nose, close your mouth and try gently blowing out your nose. Repeat every time you begin to feel that pressure

Yawning or opening your mouth wide will also help.

Lastly, chewing gum may help relieve this pressure.

If the above suggestions do not resolve the ear pressure, open the red relief knob until the feeling of pressure is gone. Then close the red knob to continue to pressurize the chamber. The red relief knob will allow you to control the speed of pressurization to aid in equalizing the pressure on your ears.



DURING TREATMENT

WHAT TO WEAR

You may wear any type of clothing in the chamber; however, comfortable and soft clothing is typically used. Do not wear shoes inside the chamber.

DURING TREATMENT

WHAT TO BRING INTO THE CHAMBER

Feel free to bring food, drinks, books and personal computers, DVD players or any other form of entertainment into the chamber.

It may also be helpful to have your cell phone with you.

We ask that you refrain from bringing in sharp objects such as forks or knives.

DEFLATING



When it is time to deflate the chamber you will turn the red knob to release the air. The red knob has three settings depending on how quickly you would like to release the air. There is a slow, medium and fast setting to release air. If you are deflating the chamber from the outside you can unplug the compressors to deflate the chamber faster.

DEFLATING



It is very important that your gauge reads zero before you
the belts and open the zippers.

unbuckle

DEFLATING



Next, unbuckle the belts.

DEFLATING

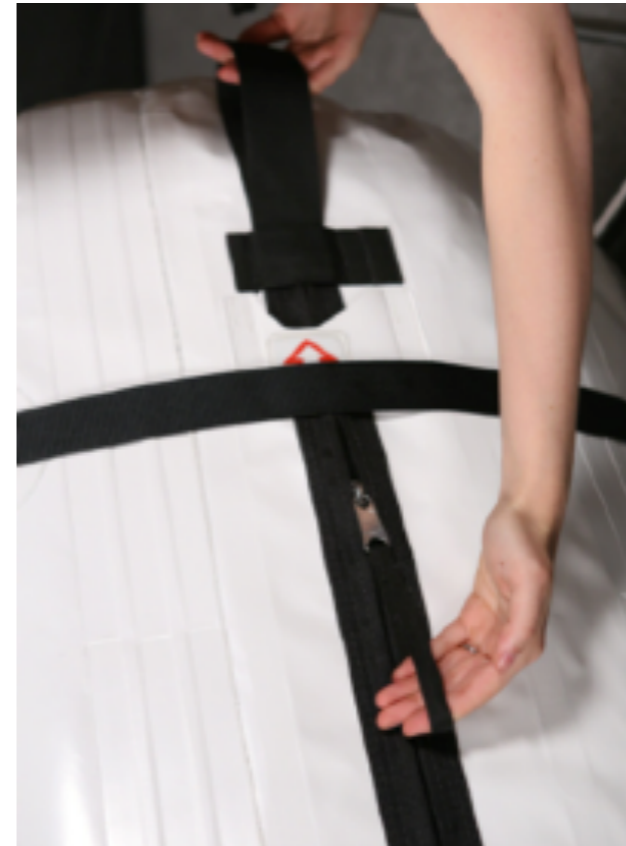

Now it is time to unzip the outside zipper.

Thread the pull tab under the safety strap.

Hold the black loop and pull the zipper pull.

the zipper all the way.

Open

DEFLATING



Next you will open the inside zipper.

Pull the zipper T on the inside zipper.

the zipper all the way.

Open

DEFLATING

DEFLATING THE CHAMBER FROM INSIDE

If you will be deflating the chamber from the inside please follow these instructions:

Turn the red knob to release the air.

Before opening the zipper, press on the chamber walls to make sure they feel soft.

Open the inside zipper.

Open the outside zipper.

Unbuckle the belts.

Step out of the chamber.

DEFLATING



The deflated chamber will look like this. You may place a chair, cushions or bean bag into the chamber.

CONGRATULATIONS

Congratulations on the purchase your Grand Dive Vertical Chamber.

Summit to Sea believes that you have purchased one of the best chambers on the market and will be totally pleased with the ease of use and the quality of craftsmanship.

Summit to Sea also believes that we have the best customer service of any hyperbaric chamber company on the market. We will always try our best to be available and give you prompt service.

If you have any questions regarding your chamber please contact your distributor first.

If you have additional questions please call us at

1-877-PSI-DIVE
(1-877-774-3483)

CHAMBER CARE

ZIPPERS

The outside zipper requires no maintenance.
Periodically, wipe the outside open zipper with a damp cloth.

CHAMBER CARE



On occasion the inside airtight zipper requires Tzip silicone lubricant. The chamber comes with this Tzip silicone to lubricate the docks where the zipper triggers are secured. It is necessary to keep this dock lubricated. Squeeze a small amount of the silicone onto your finger and spread it out on the dock. You will need to do this when it becomes difficult to seat the zipper into the dock. It is not necessary to put this silicone on the zipper itself. Periodically, wipe the open inside zipper with a damp cloth.

CHAMBER CARE

CLEANING THE CHAMBER

There is no maintenance needed other than cleaning with a non-petroleum based household cleaner.

FITTINGS & HOSES

Regularly check the fittings and hoses for cracks or damage. If you see any damage, call your distributor for a replacement part.

CHAMBER CARE

COMPRESSOR & FILTER

There is an intake fabric filter on the compressor that has the curved plastic cover.

Instructions for cleaning the filter are on the cover.

The recommendation on the compressor cover is to replace the filter once per year based on 24 hour per day usage. Since average usage will be much less, the filter life is expected to be five years.

The output filter (black) requires no maintenance. There is a green ball visible from the top of the filter. When this ball turns red, it is time to change the filter.

Contact your distributor to reorder.

CHAMBER CARE

Resetting the Safety Switch

If your compressor is jarred during shipment or operation in your home the shut off switch may be triggered. If this happens follow these instructions to reset the safety switch.

First, make sure the compressor is unplugged. You will need to remove the cover by unscrewing the four screws at the base of your compressor.

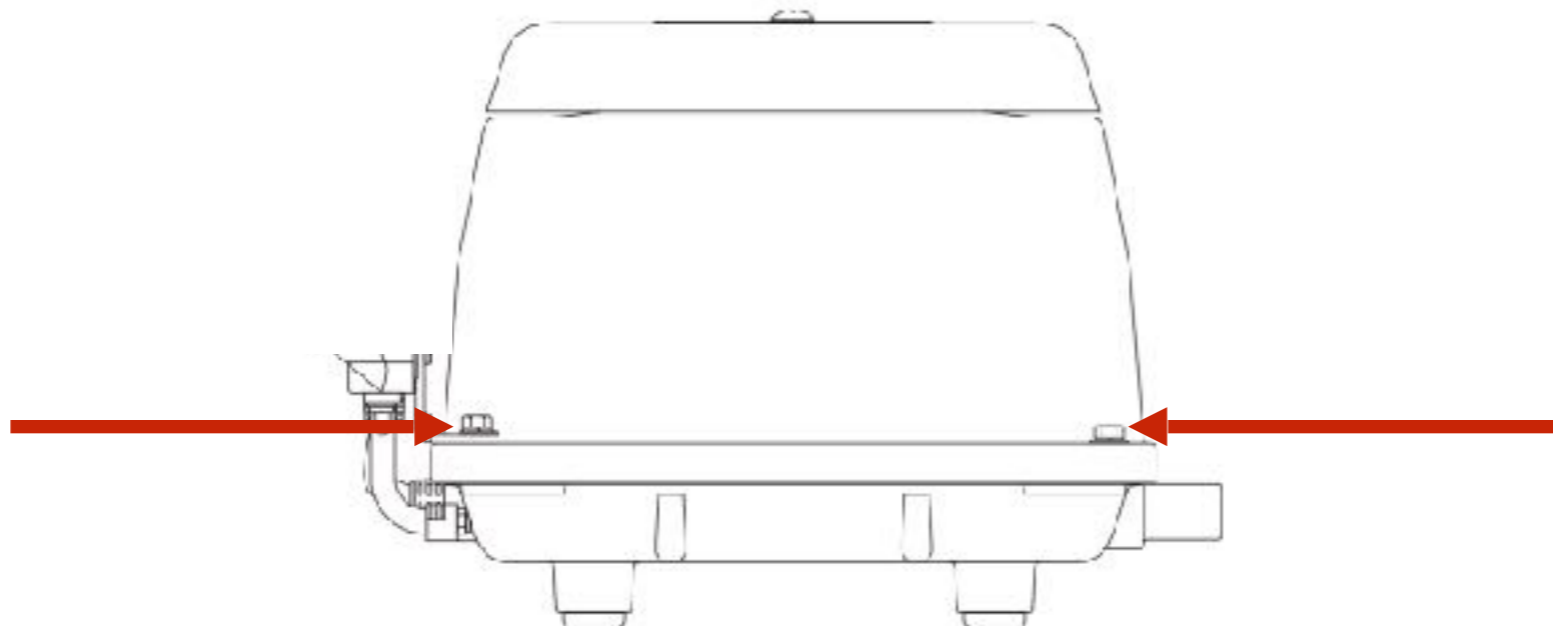

CHAMBER CARE

Resetting the Safety Switch

First you will need to remove the compressor cover by loosening the 4 screws with a pair of pliers and then using a Philips screwdriver to remove the screws.

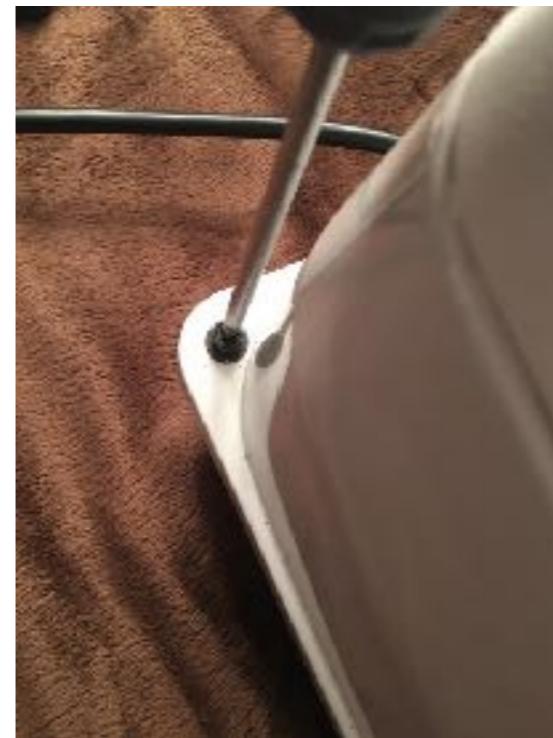
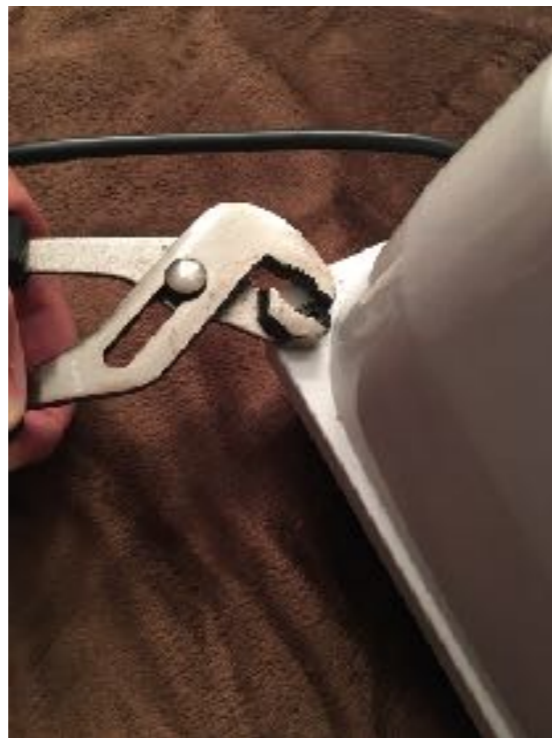

CHAMBER CARE

Resetting the Safety Switch

If the safety switch has been tripped you will see this little red button.

Move the white switch to the center of the compartment.

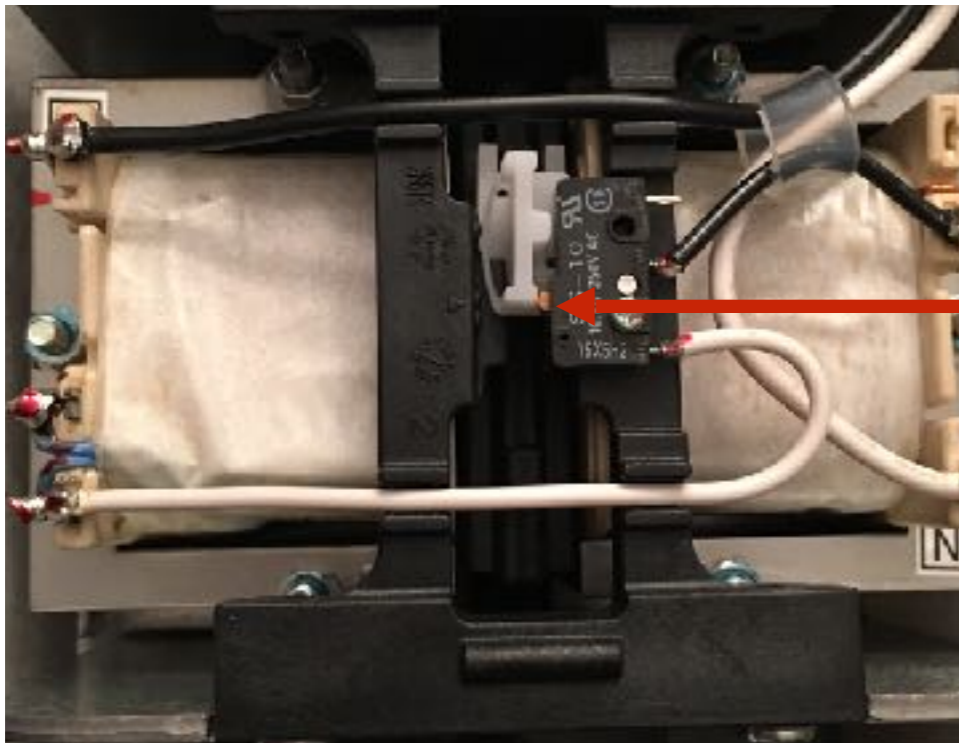

CHAMBER CARE

Resetting the Safety Switch

Next, be very careful to line up the cover with the screw holes in the base of the compressor. Tighten the screws with a Philips screwdriver. Then plug your compressors into the electric outlet.



CHAMBER CARE

White Compressor Filter

There is a filter right under the top plate of the compressor.

Clean with water every 6 months.

You will want to replace the filter every year.

You can order these filters on www.summit-to-sea.com/accessories

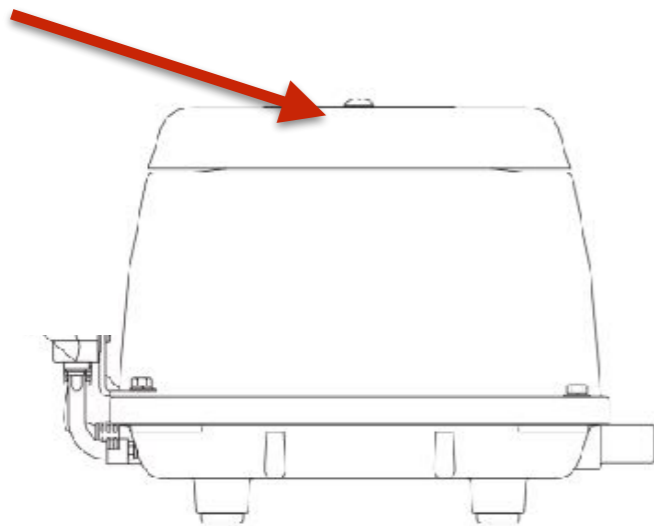

CHAMBER CARE

The .001 Micron Filter

Follow these instructions to replace this filter
You will want to replace the filter every 6 months.

You can order these filters on www.summit-to-sea.com/accessories



Lay the compressor on its side



Push the black bulb up and give it a quarter turn to unlatch then pull down



Unscrew the silver filter piece. Screw on the new silver filter



Put the black bulb back on pushing up and giving it a quarter turn to make sure it is securely connected.

CHAMBER CARE

STORAGE

Prior to storing the chamber, ensure that it has been cleaned inside and out by using a non-petroleum based household cleaner.

Carefully fold the chamber ensuring all gauges and fittings are protected with bubble wrap or a similar material.

Place the chamber in the carry case and store in a dry area between 40 and 80 degrees.

Upon first reuse, run the chamber for several hours to purge the chamber from any odors that may have collected during storage.

WARRANTY

Summit to Sea warrants our products and accessories against defect for two years from purchase. The warranty covers parts and labor to repair the Summit to Sea system. Summit to Sea, at our option and sole discretion, will repair or replace the warranty item. The warranty does not cover damage as a result of misuse or modification.

Shipping to and from Summit to Sea is the customer's responsibility.

Summit to Sea has always and will continue to cover all components on our chambers — including zipper, windows, seams, valves, hoses... in other words, if it came from Summit to Sea we will stand behind our product.

EXTENDED WARRANTY

Extended warranties are available for purchase anytime within the two year warranty period. The extended warranties also cover all components on the chamber — including zipper, windows, seams, valves, hoses, etc. Contact your distributor.

1 Year Extended warranty \$850

2 Year Extended warranty \$950

3 Year Extended warranty \$1,050

IMPORTANT TO READ

Important Safety Considerations

You should NOT use this chamber without guidance and instruction from your health care provider.

Do NOT use the chamber if you have the following conditions:

- Common colds or flu-like symptoms
- Recent alcohol consumption
- Blocked ear canals
- Blocked sinuses
- Otic barotraumas
- Excessive CO₂ exposure

IMPORTANT TO READ

CAUTIONS

CAUTION: Federal law requires this device for sale by or on the order of a physician.

CAUTION: Do not inflate the chamber with only pure oxygen; use the compressor provided. It is designed to work safely with the chamber.

CAUTION: Inspect all seams and fittings prior to use to ensure they are secure. Failure to do so could cause leaks reducing the performance of the chamber.

CAUTION: If any unusual noise or odor is detected, immediately discontinue use and contact the manufacturer. This may be an indication of a problem with the normal operation of the unit that needs to be addressed. In most situations, a simple call can resolve the issue.

IMPORTANT TO READ

WARNING: In the unlikely event that there is a rapid decompression, the individual inside the chamber must EXHALE. Please make sure that each individual receiving treatment understands this precaution.

WARNING: Do not replace the compressor with any other model. The chamber is designed to work specifically with the compressor provided. For added safety, the compressor will not exceed the test pressure for the chamber.

WARNING: Do not tamper with the pressure regulation valves. These are factory set and there are no user adjustments. Any sign of tampering with these valves will void the warranty.

WARNING: Do not use the chamber in a manner where the chamber could roll off the surface causing a fall. Always use on a surface large enough to prevent rolling off and causing a fall.

WARNING: Never take a treatment alone. Always have someone outside the chamber to assist you.

WARNING: Do not use the electric compressor in the rain or around running water as this could cause electric shock.

WARNING: Wear comfortable clothing and lay on a mat, towel or blanket while in the chamber to limit contact with the chamber surface and to improve comfort and safety.

IMPORTANT TO READ

Pressure Regulation Valves (Relief Valves)

Summit to Sea Chambers utilizes redundant pressure regulation valves. These are factory programmed to ensure a steady, constant pressure. During treatment, there will be a steady flow of fresh air through the chamber. For proper operation, the air compressor is to be running throughout the entire treatment. This is important to ensure that CO₂ build up does not occur.

These valves exhaust the old air while maintaining the factory operating pressure. This pressure is set to 1.3 ATA (4.4 PSI).

WARNING: Do not tamper with the pressure regulation valves. These are factory programmed and have no user adjustments. Any sign of tampering with these valves will void the warranty.

IMPORTANT TO READ

Buckles- We have selected one of the most secure buckles on the market to ensure your safety and comfort.

Bolsters- All chambers come with fitted bolsters that are an integrated part of the chamber.

Compressor- Ultra quiet compressors provide patented sound suppression which permits a restful and relaxing dive experience. These highly compact compressors are designed for continuous operation providing you with a longlasting solution to hyperbaric pressurization needs. This compressor is small and compact making it easy to transport. With its small carbon footprint, this compressor will easily integrate into your environment.

Oil-less 80/120 with a flow rate of 80 to 160 liters per minute and a max operating pressure of 6 PSI. See compressor manual included in the compressor box.

CAUTION: Using any other compressor with the Hyperbaric Dive units will void the warranty and may cause injury to the occupant and/or the attendant.

Frame- We have designed this lightweight, highly durable frame. It is easily assembled and disassembled so that your chamber can be as mobile as your lifestyle.

IMPORTANT TO READ

Valves-The Grand Dive has three pressure release valves to ensure a safe and comfortable operation. This redundancy assures your safety. The Shallow and the Dive have two release valves.

Windows-The window has a five layer, one firm acrylic layer between four vinyl layers to ensure a long lasting, permanent seal.

Zipper- An airtight zipper securely seals the air pressure inside the chamber without the need to massage or manipulate the seal, along with a heavyduty zipper to ensure the integrity of the chamber.

With over thirty years of manufacturing experience of hyperbaric chambers, our group of experts have gained the experience and knowledge of hyperbaric chambers and have produced a high quality product that will meet your needs today, tomorrow, and additional products for your future.

IMPORTANT TO READ

USE CARE to avoid the use of any sharp objects that may penetrate the walls of the chamber.

WARNING: Never take a treatment alone. Always have someone outside the chamber to assist you.

CLEAN the inside of the chamber with a soft, damp cloth after each use.

INSPECT all hoses for leaks.

HUMIDITY - In humid climates, the chamber will create condensation. Simply dry with a soft towel.

EARS - Be sure to chew gum or swallow often during the pressurization.

ENJOY a beverage, read a book, or enjoy any other form of entertainment.

UNZIP the chamber and inspect for foreign objects.

ENSURE that all connections are tightly secured.

ENSURE the chamber is on a stable platform or on the floor.

ATTACH the compressor hose and any accessory hoses.

DURING TREATMENT - After entering the chamber, lie on the mat and get comfortable with your book, computer, etc.

INDIVIDUAL HELPER zips up the chamber and buckles all the straps.

FILL TIME - using the frame allows for the fill time to be greatly reduced.

AIR - Once the chamber is zipped tight, you will hear the air entering the chamber and see it start to inflate.

IMPORTANT TO READ

Be sure to swallow often during the pressurization process. If you cannot clear your ears, have the individual helping you temporarily stop the compressor until the pressure in your ears releases.

Once the chamber is at full pressure, you will hear the “hissing” of the exhaust valves. This is important as it will prevent CO2 build up.

It is important to relax. Sit back and let the chamber operate. Hyperbaric treatments usually last from 30-60 minutes or longer. Check with your medical provider for recommended duration.

Allow 510 minutes for the chamber to return to normal pressure.

As air is released, check with the occupant to ensure they are equalizing the pressure at the same speed it is being reduced. Once the sides are soft, unzip the chamber.

When the chamber is clean and dry, it can be rolled up and stored or left for your next hyperbaric treatment (Be careful not to fold the window section).

CAUTION: Do NOT inflate the chamber with only pure oxygen. Use the compressor provided. It is designed to work safely with the chamber.

WARNING: If, in the highly unlikely event that there is a rapid decompression, the person inside must EXHALE.

Please make sure that each person receiving a hyperbaric treatment understands this precaution.

IMPORTANT TO READ

FDA 510K CLEARANCE

Portable Mild Hyperbaric Chambers are Class II Medical Devices.

They meet the FDA 510(k) Specifications.

The chamber has been cleared by the FDA for the treatment of Acute High Altitude Sickness.

FDA WARNING

Increasing the percentages of oxygen content in the air delivery is considered the same as administering a drug under FDA regulations.

This device is intended for use with ambient air and is not to be inflated with enriched oxygen.

SUMMIT TO SEA

To order additional:

filters

zipper lubricant

zipper cleaner

www.summit-to-sea.com/accessories

SUMMIT TO SEA



Summit to Sea
Hyperbaric Chambers

PO Box 339
Mound, MN 55364
Phone 1.877.PSI.DIVE
(1.877.774.3483)
Fax 1.877.420.7622

www.summit-to-sea.com

© 2011 Summit to Sea, LLC