



BA No.: 02.07.081/2016-12



REBOTEC

REBOTEC® Rehabilitationsmittel GmbH



User Manual

Mobile Shower Commode Chair

<p>Hamburg 356.xx.xx Height-adjustable</p>
<p>Serial Number</p>

<p>Frankfurt 355.xx.xx Height-adjustable</p>
<p>Serial Number</p>



Important suggestions!

- Read this user manual **before first use** of the chair and keep it at hand for the user.
- Keep this user manual at hand for future use and resale.
- The user instructions and the maintenance manual are downloadable on our homepage.



Product description



Hamburg



Chair picture shows:

A	Backrest
B	Armrest swingable
C	Locking pins
D	Chair frame
E	PUR seat with hygiene opening
G	Toilet seat
K	PUR seat cushion (removable)
N	Wheel complete with brakes
P	Footrests with foot plates (adjustable)
V	Commode pan
W	Pan receptacle
Z	Nameplate for product

Packaging

We recommend, if possible, keeping the packaging for later transport. This will allow secure packaging in the event of a return transport.



Table of Contents

1.	General suggestions	2
1.1	Introduction	2
1.2	Symbol	2
1.3	Intended proper use	3
1.4	Use and storage	3
1.5	Features	3
2.	Warranty	3
3.	Spare parts orders, complaints	3
4.	Reuse, lifetime	3
5.	Disposal	3
6.	Safety instructions for use	4
7.	Product specifications	4
7.1	Scope of delivery	4
7.2	Technical specifications	4
8.	Spare parts, accessories	5
9.	Setting up the chair for use	5
10.	Using the chair	5
10.1	Sitting down	6
10.2	Getting up	6
10.3	Swivelling the armrests outwards	6
10.4	Adjusting the footrest height	6
10.5	Folding away footrests	6
10.6	Removing the footrests	6
10.7	Removing the seat	6
10.8	Removing the back cushion	6
10.9	Handling the commode pan	6
10.10	Adjusting the seat height	6
11.	Troubleshooting	7
12.	Care	8
13.	Maintenance, Repair	8

1. General suggestions

1.1 Introduction

In this manual you will find information on safe and proper installation, use, operation, maintenance and care of the chairs.

Read these operating instructions carefully before using the product. Note in particular the safety instructions and act accordingly.

1.2 Symbol



Read the User Manual!

Product conforms to the
Medical Products Directive 93/42/EEC

**Caution!**
Information**Information!****Danger – Follow safety advisories!**

Care



Maintenance

1.3 Intended proper use, advisories

The shower/commode wheel chair is for homecare and out-patient purposes. The chair is to be used exclusively for assistance during showering or bathing, using a toilet or for transfer of persons inside buildings.

The shower/commode wheel chair is not designed for long periods of sitting.

1.4 Use and storage

**Watch out! Risk of damage**

The operating temperature of the product should be between **+5 degrees to +40 degrees (Celsius)**. Store the product in a dry place at a temperature between **0 to +40 degrees (Celsius)** and humidity of **30-55%**. Outside these conditions, the product could be used only shortly. Do not store the product near heat sources. Avoid direct sunlight on the product.

The chair is not suitable for use in wet areas (e.g. for saunas, areas with swimming pool-like conditions), as surface discoloration and adverse effects on the mechanical strength can result.

1.5 Features

The chairs are made of a corrosion-resistant frame and four rubber-wheeled castors with locking brakes for the back castors. The armrests can be swivelled outwards. The footrests are height-adjustable and can be removed and folded away. The chairs can be rolled over a conventional bathroom toilet.

Shower wheel chair

The shower wheel chair may be used where the use of or access to a conventional shower or bathtub is no longer possible due to patient physical limitations. The shower must be designed so that the wheel chair can be rolled into it unhindered.

Commode wheel chair

The commode wheel chair may be used where the use of or access to a conventional toilet is no longer possible due to patient physical limitations. The seat surface has a toilet-like cut-out under which a toilet pan can be pushed in.

Shower and commode wheel chair

A shower and commode wheel chair is a combination of both applications.

2. Warranty

The product has a warranty of **2 years**, when noticing/respecting our general terms and conditions and the intended use of the product. Unauthorized changes made to the product, without the consent of the manufacturer will void the warranty.



The delivery date written on the REBOTEC-delivery note applies as the valid start date of the warranty period.

3. Nameplate / ordering of spare parts

On the nameplate you can find the following important information:

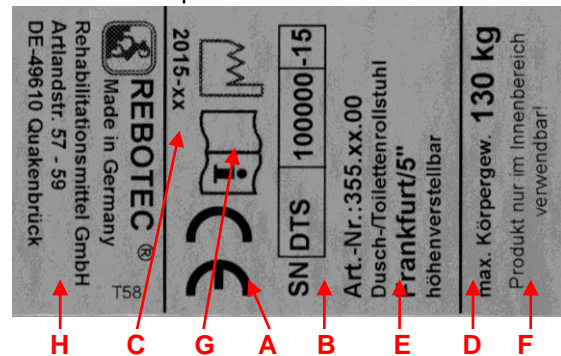

A	Mark of conformity (CE)
B	Serial number-product
C	Production year
D	Max. body weight
E	Product name
F	Note (use)
G	Read User Manual
H	Manufacturer details

The name-plate is very important for product identification, and thus must not be removed.

4. Reuse, lifetime

The product is suitable for reuse. The number of re-operations depends on the frequency of use and manner of use of the product. Before reuse, the product needs to be hygienically prepared and if necessary the technical-functional safety of the product need to be renewed.

If the product is used as intended, according to the safety, the lifetime of the product is 5 years. The effective lifetime depends on the frequency and intensity of use, and the general condition.

5. Disposal

Products that can no longer be used are to be disposed of separately from regular household rubbish. This must be done according to the local and national regulations for environmental protection and raw material recycling. Please contact your local disposal company or officials for further information.



6. Safety advisories for use



When using the chair, the following safety instructions must be observed:

Danger of slipping!

- Before using, check to be sure the seat is securely pressed into the seat frame.
- Always lock the swivel castors before using the roll chair. This is to prevent the chair from rolling away.
- When sitting down into the chair, the user must not sit on the front edge of the seat or seat cushion. Be sure the user sits all the way back on the seat.

Danger of tipping over!

- The chair may be used only when the armrests are locked into position, when sitting and when rolling.
- The chair may be pushed only using the push bow (backrest).
- The footrests must be swivelled away or folded up whenever the patient sits down or gets up. The patient must never attempt to stand on the footrests.
- The chair must not bump into door sills, jambs or against edges.
- Use the chair only indoors and on solid, even, non-slippery surfaces.
- The chair may be pushed only at a walking speed or less (with or without the patient).
- Do not lean out of the chair (when the chair is still or in motion). If the swivel castors are swivelled inwards, then the stability of the chair is decreased.
- When adjusting the height of the chair, always observe the applicable instructions.

Danger of breakage!

- **The chair is suitable only for transporting persons. Be sure to observe the maximum allowable patient body weight (specified on the nameplate)!**
- **Never** attempt to carry or lift the chair while a patient is sitting in it.
- Do not grab hold of or pull on attached objects, such as IV Pole, armrest cushions.

Danger of pinching!

- To prevent body parts or objects from getting pinched, never reach into the hinge area when turning the armrests up or down. Be sure to check that the hinge areas are unobstructed before moving the armrests!
- To prevent body parts from getting pinched, do not reach between the seat and the frame when pressing the seat into the seat frame.
- Be sure other parts do not get jammed when folding and unfolding the footrests.

Danger of falling!

- Sitting down, standing up and moving the patient should be supervised by a qualified care-worker, as to the health condition of the patient.
- Use of the chair by patients who do not have complete physical control and normal movement must not be done unsupervised.
- Rolling the chair on any sloped surface may be done only with the assistance of a care worker.

Warning! Danger of Injury!

- At surface temperatures over 40°C (104°F), there's a risk of injury. Therefore do not expose the chair to any source of heat (exposure to the sun, storing near a heater, cleaning with hot water) just before the chair is used. Before using the chair, allow it to cool down.

Before using the chair from patients with insensitive skin (persons who can't feel any increase of temperature and /or with skin damage) the caregiver has to make a thermal check (with the back of the hand).

Observe the instructions of use (see 1.4).

7. Product specifications

7.1 Scope of delivery

The product has been carefully inspected in the factory for freedom of defects and for completeness. After having received it, carefully check over the product for possible transport damages and for completeness.

- 1 shower / commode wheel chair
- 1 back-rest
- 1 seat
- 1 commode pan with lid
- 1 Allen wrench
- 1 User Manual

7.2 Technical specifications

We reserve the right to make technical developments and improvements with respect to the design shown in the User Manual.

Production tolerance of dimensions: +/- 5 mm

Dimensions(ca.)	Hamburg	Frankfurt
A. height	1020-1070 mm	1020-1070 mm
B. width	560 mm	560 mm
C. depth	870 mm	870 mm
D. seat height	540-590 mm	560-610 mm
E. seat width	460 mm	460 mm
F. seat depth	460 mm	460 mm
G1. clearance*	450-500 mm	440-490 mm
G2. clearance*	480-530 mm	480-530 mm
H. foot height	330-480 mm	350-500 mm
I. wheel 5"	125 mm	125 mm
Body weight	Max. 130 kg	Max. 130 kg
Product weight **	18 kg	18 kg

* Clearance: G1 with pan receptacle =, G2= without pan receptacle

**Figure: product weight without accessories

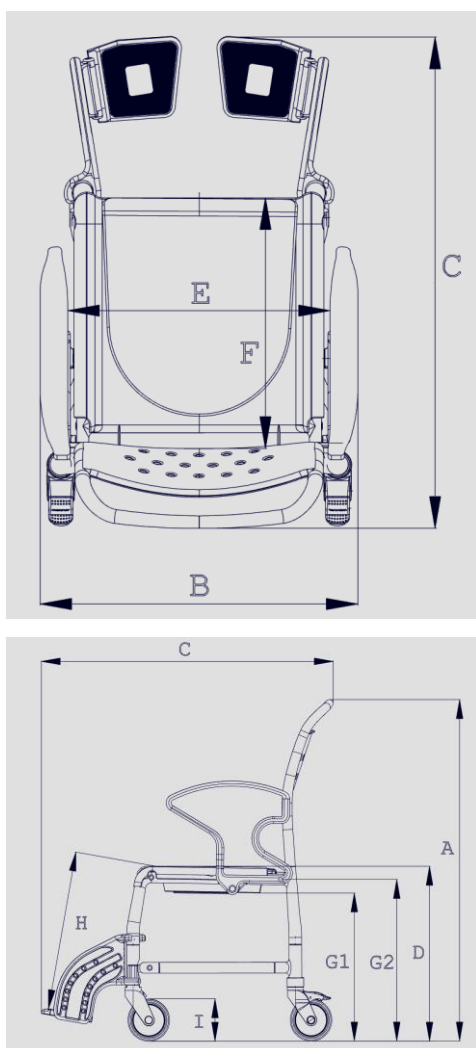

8. Spare parts, accessories

Article No.	Name
301. *	Commode pan with lid
309. *	Pan receptacle
440.10.04	PUR seat with opening, black
440. *.62	PUR seat cushion
307. *	Commode seat for Hamburg
02.07.081	User Manual
Accessories	
303.62	Assembly set IV Pole
02.11.150	Maintenance Instructions

* Provide the colour

9. Setting up the chair for use

The product is delivered partially pre-assembled. The following assembly instructions must be carried out before first-time use:

1. Turn the footrests forwards until they click into position. Then unfold the foot-plates downwards. Finally adjust the height of the footrests (see: 10.4).

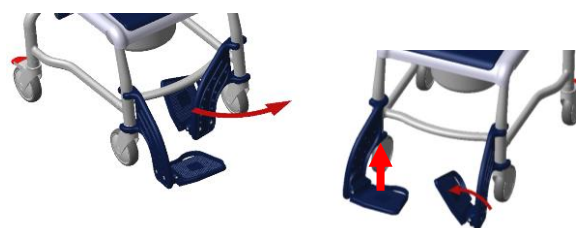

2. Swivel the armrests to the back, insert the backrest into the tubes of the chair frame and push it down until it hits the striker of the lower frame.

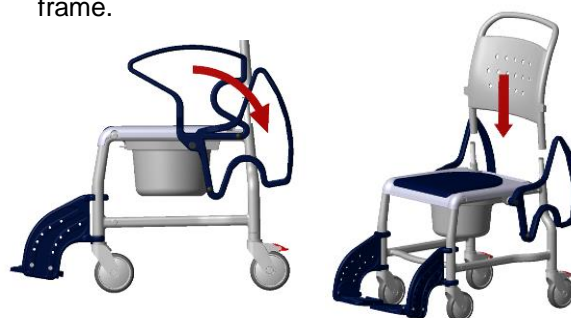

3. Swivel the armrests forwards until they click into the slots of the backrest and the locking pins click into the lower frame. Be sure they are securely in place.

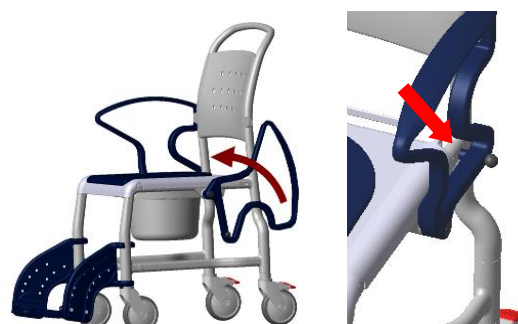

4. The seat height of the chair is set at its lowest position for delivery (Base setting). Adjust the height as necessary (see: 10.10).
5. For the eventual installation of the IV Pole (accessory), use the User Instructions that are included with it.

10. Using the chair

When using the chair, the following points must be adhered to:



Before use it must be assured that the chair is in a proper condition for safe use. If necessary, depending on the physical and strength limitations of the user (patient's ability to move and muscle strength), sitting down and getting up **should not be done without assistance from a care worker**. The chair may not be used for long patient transport times.

10.1 Sitting down

Before sitting down in the chair, be sure it is secured against slipping away (**see: 10.9**) and tipping over, that the armrests are locked into position, that the shower/commode seat is properly mounted, and that the footrests are folded away to the side or folded up.

1

The patient must stand as closely as possible near the chair. Then he has to sit down slowly on the whole seat while supporting himself using both armrests.

If this is not possible due to his physical limitations, then a care-worker must assist him. If necessary a patient lifter may have to be used.

2

Caution – danger of falling!

To prevent the patient from falling out of the chair, be sure the patient is seated completely on the chair, and not just on the edge.

For transporting the patient, be sure he is leaned back against the seat back and be sure he uses the footrests.

10.2 Getting up

Before getting up, be sure the chair is stable and secured against slipping away (**see 10.9**) and tipping over, that the armrests are locked in position, and the footrests are folded away to the side or folded up.

The patient must then move his body forward until his feet are flat on the floor.

3

The patient must then place both hands on the armrests and slowly lift himself up.

The patient must not lean too far forwards, in order to avoid falling.

The patient should have the care worker assist him when getting up.

4

Caution – danger of falling!

The patient must not stand on the footrests when getting up or leaving the chair.

10.3 Swivelling the armrests outwards

By pulling out the locking pin, the locking mechanism is disengaged and the armrests may be swivelled back

When swivelling the armrests up, check to be sure that the armrests are properly seated in the locking position of the backrest and locked by the locking pin.



Check the locking mechanism on a regular basis for impaired function arising from calcium deposits, which can impair the movement.

10.4 Adjusting the foot support height

The footrests are height-adjustable in stages. To do this, unscrew the screws of the footrests on the side using an SW6 Allen key.

Select the appropriate height and tighten the screws of the footrest. Be sure the screw is securely tightened.

10.5 Folding away the footrests

Swivel the footplates upwards and lift the footrests. The footrests can now be swivelled back to the side.

10.6 Removing the footrests

Lift up the footrests approx. 100 mm and turn them outwards 90°. Now you can lift the footrests up and remove them.

10.7 Removing the seat

The seat can be removed from its receptacles for the purpose of cleaning or exchanging simply by pulling it up.

10.8 Using the wheel locks

To lock the wheels, press the locking levers down with your foot. The wheels are now locked and not loose. Releasing the wheels is done by lifting up the locking levers.

10.9 Handling the commode pan

Push the commode pan under the seat from behind the chair. To remove the pan, lift it up slightly and pull it out.

10.10 Adjusting the seat height

To allow adjustment of the seat height for the patient or to allow driving over an elevated toilet bowl, the chair is height adjustable.

The height adjustment is done through the 4 castor wheels in the seat frame (2 stages: each 25 mm).



Caution: Danger of tipping! Be sure that all four wheels are set at the same height and that the screws are securely tightened by hand.

**Step 1**

To do the adjustment, we recommend laying the chair on its side. First remove the commode pan and the seat cover.

**Step 2**

Push the footrests up on the chair legs.

**Step 3**

Using an Allen wrench (A/F 5 mm), completely remove the screws (LH rotation) at the wheel units. When loosening the screws, press against the locking nut.

Front**Back****Step 4**

Pull the castor unit out until the hole lines up with the next adjustment level. Screw the castor unit until tight (RH rotation). Do not forget the locking nut on the back side. Push the foot rests back down. Before using, clean the chair.

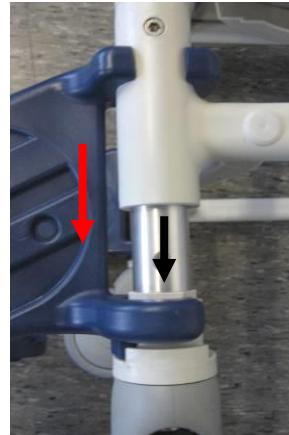
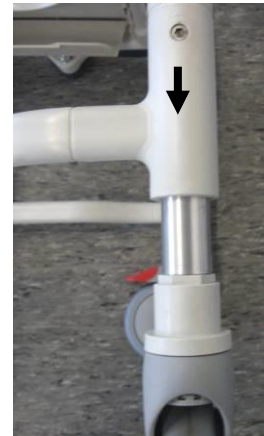
Front**Back****11. Troubleshooting**

Fault	Poss. cause	Correction
Armrests do not swivel properly	Locking pins are caked up with deposits	Clean, check periodically
Locking pins cannot be pulled out	Caked up, tension spring is jammed or defective	Clean, replace locking pin
Footrests do not swivel properly	Caked up joints, jamming	Clean, check screw connection
Castor wheels do not lock	Generally defective	See Section Maintenance!
Wheel turns with difficulty	Deposits build-up	Clean
Wheel do not rotate	Generally defective	See Section Maintenance
Wheels no longer round	Wheels unevenly worn	See section on Maintenance
Chair frame too unstable	Screws are loose	Tighten frame and castor screws
Castors are bent	Bumped into objects	See Section Maintenance!



12. Care



In general the chair can be cleaned using a mild conventional cleaning and disinfecting agent. Simply wipe the chair with clean water and cloth, and then wipe dry with a clean cloth.

Do not use an abrasive scouring agent or cleaner (read the product instructions!) that contain aggressive solvents (acids, thinners). Do not use stiff cleaning brushes, as these will damage the plastic surfaces or cause deposits to build up on the plastic parts and other materials.

- **i** *Keep the product clean and clean it in regular intervals. In the sensitive areas is hygiene very important.*

13. Maintenance, Repair

The cause of accidents or damage may be due to the late detection of wear and/or improper use, as well as irregular or no maintenance.



For safety reasons and for preventing accidents, the chair must undergo a **complete maintenance at least once a year**. (Refer to the Medical Products Act and the MPBetreibV).



Maintenance

Periodic safety-related controls are needed:

- Check for apparent damage (cracks, fractures, loose parts).
- All screwed connections for tightness (especially the castor wheels and the frame).
- Function of the armrests and locking pins.
- Function of the footrests (replace defective foot plates).
- Rolling ability, check function of the wheels (replace defective wheels).
- Check accessories for defects.



Repair

- If you have questions concerning maintenance and repairs to the chair, then contact an authorized dealer or medical equipment supply outlet.
- When making repairs, use only original spare parts from REBOTEC. Observe all advisories concerning guarantee and warranty.
- Never make any unauthorised modifications or conversions to the chair. These will only adversely affect the safety and function of the chair.

In such cases REBOTEC assumes no liability!

- Follow all the instructions when ordering spare parts, re-use and product lifetime of the chair.

- After a complete maintenance or repair of the chair is done, we recommend a complete cleaning for assuring hygiene. Follow the cleaning instructions.

We also supply

Walking aids

Shoulder crutches

Shower stools

Shower and commode chairs

Multifunction-Wheel Chairs Rollators

Patient lifting hoists Standing up aids

Your **REBOTEC** Team