

LITTLE



Tools for the job of living

Quotes@RehabMart.com

1-800-827-8283

3651 Mars Hill Rd, Bldg 2400

Watkinsville, GA 30677-6042

USA

CHAIR INFORMATION	
LITTLE DIPPER K0009	
Adjustable FSH-RSH	
Max. Capacity 250Lbs	
NOTE	
Main Frame : ZK55 & ZK60 High Grade A7000 Series Aluminum	
Main Frame : Lifetime Warranty(5 YEARS)	
*See warranty policy	

A FRAME COLORS & PARTS COLORS

FRAME COLORS	
Powder-Co	<input type="checkbox"/> Gloss Black <input type="checkbox"/> Twilight Flake <input type="checkbox"/> Yellow <input type="checkbox"/> Magenta <input type="checkbox"/> Fire Engine Red <input type="checkbox"/> White <input type="checkbox"/> Neon Yellow <input type="checkbox"/> Candy Blue <input type="checkbox"/> Candy Purple <input type="checkbox"/> Candy Green <input type="checkbox"/> Candy Red <input type="checkbox"/> Candy Raspberry <input type="checkbox"/> Cobalt Blue <input type="checkbox"/> Brass Metallic <input type="checkbox"/> Matte Gray <input type="checkbox"/> Matte Purple <input type="checkbox"/> Matte Blue <input type="checkbox"/> Matte Green <input type="checkbox"/> Matte Black <input type="checkbox"/> Matte Red <input type="checkbox"/> Tiffany Blue <input type="checkbox"/> Neon Red <input type="checkbox"/> Neon Green <input type="checkbox"/> Orange Sparkle <input type="checkbox"/> Mellon Yellow <input type="checkbox"/> Gun Smoke Silver <input type="checkbox"/> Shocker Yellow <input type="checkbox"/> Sparkle Burgundy <input type="checkbox"/> Granny Sparkle Green <input type="checkbox"/> Sparkle Sky Blue <input type="checkbox"/> Reed Green <input type="checkbox"/> Blue Lilac
Special C	<input type="checkbox"/> Polished <input type="checkbox"/> 24 karat Gold
PARTS COLORS (Custom Parts Color Section, Please see Section C)	
STD Color	Black Color (*Suspension Springs-Silver Color Only)-
Custom Color Main Bolt on Parts One Color Package	<input type="checkbox"/> Powder-Coated (.....).. <input type="checkbox"/> Polished <input type="checkbox"/> 24 karat Gold
Including: Backrest, Foot Plate, Footrest Rings, Backrest Brackets , Saddle Stops, Forks & Knurl Nuts, Caps, Front Suspension Springs, Caster Housings Axle Plate & Axle Base ☆marked parts	

B FRAME MEASUREMENTS 1/2

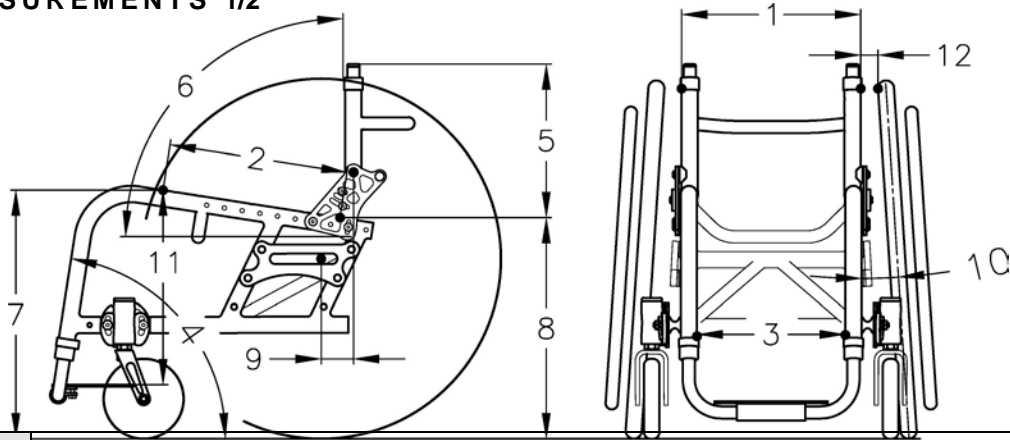

1. SEAT WIDTH	<input type="checkbox"/> 10" <input type="checkbox"/> 11" <input type="checkbox"/> 12" <input type="checkbox"/> 13" <input type="checkbox"/> 14" <input type="checkbox"/> 15"
----------------------	---

2. SEAT DEPTH * Only Choose One Option	Depth Adj. Frame Only	<input type="checkbox"/> Short Frame (11" Depth) Set at <input type="checkbox"/> 8" <input type="checkbox"/> 9" <input type="checkbox"/> 10" <input type="checkbox"/> 11"
	<input type="checkbox"/> STD Frame (14" Depth) Set at <input type="checkbox"/> 10" <input type="checkbox"/> 11" <input type="checkbox"/> 12" <input type="checkbox"/> 13" <input type="checkbox"/> 14"	

<input type="checkbox"/> Aluminum Seat Pan <input type="checkbox"/> Positioning Frame Add (")	E2231	
--	--------------	--

3. FOOTREST WIDTH	<input type="checkbox"/> STD (Seat Width Minus 2", No Taper Frame) <input type="checkbox"/> Custom (") *Reverse Taper on Top Only *Measurement must be same or wider than your Seat Width.
--------------------------	---

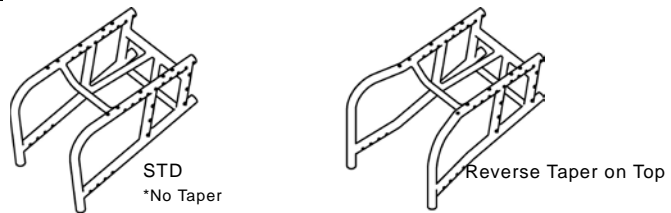

FOOT PLATE STYLE	<input type="checkbox"/> Standard single loop with adjust. height & angle. STD Foot Plate K0040 <input type="checkbox"/> Single Flip-Back-single loop (no riser avail) with adjust. height & angle. STD Foot Plate K0040
-------------------------	---

STD Foot Plate Size Chart

Your Footrest Width	Foot Plate Size
8.0" - 10.5"	W6.5"xD5"
11.0" - 12.5"	W8.5"xD6.5"
13.0" - 17.0"	W11"xD6.5"

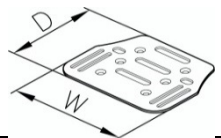

CUSTOM FOOT PLATE	<input type="checkbox"/> Custom Foot Plate with adjust. height & angle K0040 *Available Solid Plate Only <input type="checkbox"/> Drill 2Sets Extra Holes in Footplate <input type="checkbox"/> Custom Tubular Footrest *Not Available High Mount Footrest.	
		<input type="checkbox"/> With ABS Foot Plate (\$75 up charge)

4. FRAME ANGLE	<input type="checkbox"/> 75° <input type="checkbox"/> 80° <input type="checkbox"/> 85° <input type="checkbox"/> 90° to the ground <input type="checkbox"/> Custom (°) to the ground
-----------------------	---

B FRAME MEASUREMENTS 2/2

5. BACKREST HEIGHT <small>* Rigidizer bar 3.25" deep std.</small>	<input type="checkbox"/> 8" <input type="checkbox"/> 9" <input type="checkbox"/> 10" <input type="checkbox"/> 11" <input type="checkbox"/> 12" <input type="checkbox"/> 13" <input type="checkbox"/> 14" <input type="checkbox"/> 15" <input type="checkbox"/> 16" <input type="checkbox"/> 17" <input type="checkbox"/> 18"																																																																																																																																																	
Type	<input type="checkbox"/> Locking mechanism with adjust. height & angle																																																																																																																																																	
	<input type="checkbox"/> Double Locking mechanism with adjust. height & angle																																																																																																																																																	
	<input type="checkbox"/> Folding with adjust. height & angle																																																																																																																																																	
<input type="checkbox"/> Custom Backrest - (ie: double rigidizer bars, custom depth, custom height, etc)																																																																																																																																																		
6. BACKREST ANGLE	Set at (°) to the ground *STD 90°																																																																																																																																																	
7. FRONT SEAT HEIGHT	<input type="checkbox"/> 14.5" <input type="checkbox"/> 15.0" <input type="checkbox"/> 15.5" <input type="checkbox"/> 16.0" <input type="checkbox"/> 16.5" <input type="checkbox"/> 17.0" <input type="checkbox"/> 17.5" <input type="checkbox"/> 18.0" <input type="checkbox"/> 18.5"																																																																																																																																																	
Front Seat Height Ranges <small>*=Not Available with Quick Release Caster Axle.</small> The front seat heights are impacted by the size of your front caster.	<table border="1" style="width:100%; border-collapse: collapse; text-align: center;"> <thead> <tr> <th colspan="2" rowspan="2"></th> <th colspan="10">Front Seat Height</th> </tr> <tr> <th>14.5"</th><th>15.0"</th><th>15.5"</th><th>16.0"</th><th>16.5"</th><th>17.0"</th><th>17.5"</th><th>18.0"</th><th>18.5"</th> </tr> </thead> <tbody> <tr> <td rowspan="9" style="writing-mode: vertical-rl; transform: rotate(180deg);">Your Casters & Forks</td> <td>3" Caster & STD Forks</td> <td><input type="checkbox"/>*</td><td><input type="checkbox"/>*</td><td></td><td></td><td></td><td></td><td></td><td></td><td></td><td></td> </tr> <tr> <td>3" Caster & Springs</td> <td></td><td></td><td></td><td></td><td></td><td></td><td></td><td></td><td></td><td></td> </tr> <tr> <td>3" Caster & Frog Legs</td> <td></td><td></td><td></td><td><input type="checkbox"/>*</td><td><input type="checkbox"/>*</td><td><input type="checkbox"/>*</td><td><input type="checkbox"/>*</td><td><input type="checkbox"/>*</td><td></td><td></td> </tr> <tr> <td>4" Caster & STD Forks</td> <td></td><td></td><td><input type="checkbox"/></td><td><input type="checkbox"/></td><td><input type="checkbox"/></td><td><input type="checkbox"/></td><td><input type="checkbox"/></td><td><input type="checkbox"/></td><td></td><td></td> </tr> <tr> <td>4" Caster & Springs</td> <td></td><td></td><td></td><td><input type="checkbox"/></td><td><input type="checkbox"/></td><td><input type="checkbox"/></td><td><input type="checkbox"/></td><td><input type="checkbox"/></td><td></td><td></td> </tr> <tr> <td>4" Caster & Frog Legs</td> <td></td><td></td><td></td><td><input type="checkbox"/>*</td><td><input type="checkbox"/>*</td><td><input type="checkbox"/>*</td><td><input type="checkbox"/>*</td><td><input type="checkbox"/>*</td><td><input type="checkbox"/>*</td><td></td> </tr> <tr> <td>5" Caster & STD Forks</td> <td></td><td></td><td></td><td></td><td><input type="checkbox"/>*</td><td><input type="checkbox"/></td><td><input type="checkbox"/></td><td><input type="checkbox"/></td><td><input type="checkbox"/>*</td><td></td> </tr> <tr> <td>5" Caster & Springs</td> <td></td><td></td><td></td><td></td><td><input type="checkbox"/>*</td><td><input type="checkbox"/>*</td><td><input type="checkbox"/>*</td><td><input type="checkbox"/>*</td><td><input type="checkbox"/>*</td><td><input type="checkbox"/>*</td> </tr> <tr> <td>5" Caster & Frog Legs</td> <td></td><td></td><td></td><td></td><td></td><td><input type="checkbox"/>*</td><td><input type="checkbox"/>*</td><td><input type="checkbox"/>*</td><td><input type="checkbox"/>*</td><td><input type="checkbox"/>*</td> </tr> </tbody> </table>			Front Seat Height										14.5"	15.0"	15.5"	16.0"	16.5"	17.0"	17.5"	18.0"	18.5"	Your Casters & Forks	3" Caster & STD Forks	<input type="checkbox"/> *	<input type="checkbox"/> *									3" Caster & Springs											3" Caster & Frog Legs				<input type="checkbox"/> *	<input type="checkbox"/> *	<input type="checkbox"/> *	<input type="checkbox"/> *	<input type="checkbox"/> *			4" Caster & STD Forks			<input type="checkbox"/>	<input type="checkbox"/>	<input type="checkbox"/>	<input type="checkbox"/>	<input type="checkbox"/>	<input type="checkbox"/>			4" Caster & Springs				<input type="checkbox"/>	<input type="checkbox"/>	<input type="checkbox"/>	<input type="checkbox"/>	<input type="checkbox"/>			4" Caster & Frog Legs				<input type="checkbox"/> *	<input type="checkbox"/> *	<input type="checkbox"/> *	<input type="checkbox"/> *	<input type="checkbox"/> *	<input type="checkbox"/> *		5" Caster & STD Forks					<input type="checkbox"/> *	<input type="checkbox"/>	<input type="checkbox"/>	<input type="checkbox"/>	<input type="checkbox"/> *		5" Caster & Springs					<input type="checkbox"/> *	<input type="checkbox"/> *	<input type="checkbox"/> *	<input type="checkbox"/> *	<input type="checkbox"/> *	<input type="checkbox"/> *	5" Caster & Frog Legs						<input type="checkbox"/> *	<input type="checkbox"/> *	<input type="checkbox"/> *	<input type="checkbox"/> *	<input type="checkbox"/> *																								
				Front Seat Height																																																																																																																																														
		14.5"	15.0"	15.5"	16.0"	16.5"	17.0"	17.5"	18.0"	18.5"																																																																																																																																								
Your Casters & Forks	3" Caster & STD Forks	<input type="checkbox"/> *	<input type="checkbox"/> *																																																																																																																																															
	3" Caster & Springs																																																																																																																																																	
	3" Caster & Frog Legs				<input type="checkbox"/> *	<input type="checkbox"/> *	<input type="checkbox"/> *	<input type="checkbox"/> *	<input type="checkbox"/> *																																																																																																																																									
	4" Caster & STD Forks			<input type="checkbox"/>	<input type="checkbox"/>	<input type="checkbox"/>	<input type="checkbox"/>	<input type="checkbox"/>	<input type="checkbox"/>																																																																																																																																									
	4" Caster & Springs				<input type="checkbox"/>	<input type="checkbox"/>	<input type="checkbox"/>	<input type="checkbox"/>	<input type="checkbox"/>																																																																																																																																									
	4" Caster & Frog Legs				<input type="checkbox"/> *	<input type="checkbox"/> *	<input type="checkbox"/> *	<input type="checkbox"/> *	<input type="checkbox"/> *	<input type="checkbox"/> *																																																																																																																																								
	5" Caster & STD Forks					<input type="checkbox"/> *	<input type="checkbox"/>	<input type="checkbox"/>	<input type="checkbox"/>	<input type="checkbox"/> *																																																																																																																																								
	5" Caster & Springs					<input type="checkbox"/> *	<input type="checkbox"/> *	<input type="checkbox"/> *	<input type="checkbox"/> *	<input type="checkbox"/> *	<input type="checkbox"/> *																																																																																																																																							
	5" Caster & Frog Legs						<input type="checkbox"/> *	<input type="checkbox"/> *	<input type="checkbox"/> *	<input type="checkbox"/> *	<input type="checkbox"/> *																																																																																																																																							
8. REAR SEAT HEIGHT	<input type="checkbox"/> 12.5" <input type="checkbox"/> 13.0" <input type="checkbox"/> 13.5" <input type="checkbox"/> 14.0" <input type="checkbox"/> 14.5" <input type="checkbox"/> 15.0" <input type="checkbox"/> 15.5" <input type="checkbox"/> 16.0" <input type="checkbox"/> 16.5"																																																																																																																																																	
Rear Seat Height Ranges The rear seat heights are impacted by the size of your Tires.	<table border="1" style="width:100%; border-collapse: collapse; text-align: center;"> <thead> <tr> <th>Rear Tire Size</th> <th>Rear Seat Height</th> </tr> </thead> <tbody> <tr> <td>20"x1"(451)</td> <td>12.5"- 15.0"</td> </tr> <tr> <td>20"x1 3/8"(451)</td> <td>13.0"- 15.5"</td> </tr> <tr> <td>22"x1"(501)</td> <td>13.5"- 16.0"</td> </tr> <tr> <td>22"x1 3/8"(501)</td> <td>14.0"- 16.5"</td> </tr> </tbody> </table>	Rear Tire Size	Rear Seat Height	20"x1"(451)	12.5"- 15.0"	20"x1 3/8"(451)	13.0"- 15.5"	22"x1"(501)	13.5"- 16.0"	22"x1 3/8"(501)	14.0"- 16.5"																																																																																																																																							
Rear Tire Size	Rear Seat Height																																																																																																																																																	
20"x1"(451)	12.5"- 15.0"																																																																																																																																																	
20"x1 3/8"(451)	13.0"- 15.5"																																																																																																																																																	
22"x1"(501)	13.5"- 16.0"																																																																																																																																																	
22"x1 3/8"(501)	14.0"- 16.5"																																																																																																																																																	
9. CENTER OF GRAVITY	<input type="checkbox"/> -1.5" <input type="checkbox"/> -1.0" <input type="checkbox"/> -0.5" <input type="checkbox"/> 0" <input type="checkbox"/> 0.5" <input type="checkbox"/> 1.0" <input type="checkbox"/> 1.5" <input type="checkbox"/> 2.0" <input type="checkbox"/> 2.5" <input type="checkbox"/> 3.0" <input type="checkbox"/> 3.5" <input type="checkbox"/> 4.0"																																																																																																																																																	
Center of Gravity Ranges <small>☆=Not Available 5" Caster.</small> <small>★=Not Available 22" Wheel.</small>	<table border="1" style="width:100%; border-collapse: collapse; text-align: center;"> <thead> <tr> <th colspan="2" rowspan="2"></th> <th colspan="11">Your Center of Gravity</th> </tr> <tr> <th>Seat Depth</th> <th>-1.5"</th><th>-1.0"</th><th>-0.5"</th><th>0"</th><th>0.5"</th><th>1.0"</th><th>1.5"</th><th>2.0"</th><th>2.5"</th><th>3.0"</th><th>3.5"</th><th>4.0"</th> </tr> </thead> <tbody> <tr> <td rowspan="4" style="writing-mode: vertical-rl; transform: rotate(180deg);">Short Frame</td> <td>8"</td> <td></td><td></td><td><input type="checkbox"/></td><td><input type="checkbox"/></td><td><input type="checkbox"/>★</td><td><input type="checkbox"/>★</td><td></td><td></td><td></td><td></td><td></td><td></td> </tr> <tr> <td>9"</td> <td></td><td></td><td></td><td></td><td><input type="checkbox"/></td><td><input type="checkbox"/></td><td><input type="checkbox"/>★</td><td><input type="checkbox"/>★</td><td></td><td></td><td></td><td></td> </tr> <tr> <td>10"</td> <td></td><td></td><td></td><td></td><td></td><td></td><td><input type="checkbox"/></td><td><input type="checkbox"/></td><td><input type="checkbox"/>★</td><td><input type="checkbox"/>★</td><td></td><td></td> </tr> <tr> <td>11"</td> <td></td><td></td><td></td><td></td><td></td><td></td><td></td><td></td><td><input type="checkbox"/></td><td><input type="checkbox"/></td><td><input type="checkbox"/>★</td><td><input type="checkbox"/>★</td> </tr> <tr> <td rowspan="4" style="writing-mode: vertical-rl; transform: rotate(180deg);">STD Frame</td> <td>10"</td> <td><input type="checkbox"/></td><td><input type="checkbox"/></td><td><input type="checkbox"/></td><td><input type="checkbox"/>★</td><td></td><td></td><td></td><td></td><td></td><td></td><td></td><td></td> </tr> <tr> <td>11"</td> <td></td><td></td><td><input type="checkbox"/></td><td><input type="checkbox"/></td><td><input type="checkbox"/></td><td><input type="checkbox"/>★</td><td></td><td></td><td></td><td></td><td></td><td></td> </tr> <tr> <td>12"</td> <td></td><td></td><td></td><td></td><td><input type="checkbox"/></td><td><input type="checkbox"/></td><td><input type="checkbox"/>★</td><td></td><td></td><td></td><td></td><td></td> </tr> <tr> <td>13"</td> <td></td><td></td><td></td><td></td><td></td><td><input type="checkbox"/></td><td><input type="checkbox"/></td><td><input type="checkbox"/></td><td><input type="checkbox"/>★</td><td></td><td></td><td></td> </tr> <tr> <td></td> <td>14"</td> <td></td><td></td><td></td><td></td><td></td><td></td><td><input type="checkbox"/></td><td><input type="checkbox"/></td><td><input type="checkbox"/></td><td><input type="checkbox"/></td><td><input type="checkbox"/>★</td> </tr> </tbody> </table>			Your Center of Gravity											Seat Depth	-1.5"	-1.0"	-0.5"	0"	0.5"	1.0"	1.5"	2.0"	2.5"	3.0"	3.5"	4.0"	Short Frame	8"			<input type="checkbox"/>	<input type="checkbox"/>	<input type="checkbox"/> ★	<input type="checkbox"/> ★							9"					<input type="checkbox"/>	<input type="checkbox"/>	<input type="checkbox"/> ★	<input type="checkbox"/> ★					10"							<input type="checkbox"/>	<input type="checkbox"/>	<input type="checkbox"/> ★	<input type="checkbox"/> ★			11"									<input type="checkbox"/>	<input type="checkbox"/>	<input type="checkbox"/> ★	<input type="checkbox"/> ★	STD Frame	10"	<input type="checkbox"/>	<input type="checkbox"/>	<input type="checkbox"/>	<input type="checkbox"/> ★									11"			<input type="checkbox"/>	<input type="checkbox"/>	<input type="checkbox"/>	<input type="checkbox"/> ★							12"					<input type="checkbox"/>	<input type="checkbox"/>	<input type="checkbox"/> ★						13"						<input type="checkbox"/>	<input type="checkbox"/>	<input type="checkbox"/>	<input type="checkbox"/> ★					14"							<input type="checkbox"/>	<input type="checkbox"/>	<input type="checkbox"/>	<input type="checkbox"/>	<input type="checkbox"/> ★
				Your Center of Gravity																																																																																																																																														
		Seat Depth	-1.5"	-1.0"	-0.5"	0"	0.5"	1.0"	1.5"	2.0"	2.5"	3.0"	3.5"	4.0"																																																																																																																																				
Short Frame	8"			<input type="checkbox"/>	<input type="checkbox"/>	<input type="checkbox"/> ★	<input type="checkbox"/> ★																																																																																																																																											
	9"					<input type="checkbox"/>	<input type="checkbox"/>	<input type="checkbox"/> ★	<input type="checkbox"/> ★																																																																																																																																									
	10"							<input type="checkbox"/>	<input type="checkbox"/>	<input type="checkbox"/> ★	<input type="checkbox"/> ★																																																																																																																																							
	11"									<input type="checkbox"/>	<input type="checkbox"/>	<input type="checkbox"/> ★	<input type="checkbox"/> ★																																																																																																																																					
STD Frame	10"	<input type="checkbox"/>	<input type="checkbox"/>	<input type="checkbox"/>	<input type="checkbox"/> ★																																																																																																																																													
	11"			<input type="checkbox"/>	<input type="checkbox"/>	<input type="checkbox"/>	<input type="checkbox"/> ★																																																																																																																																											
	12"					<input type="checkbox"/>	<input type="checkbox"/>	<input type="checkbox"/> ★																																																																																																																																										
	13"						<input type="checkbox"/>	<input type="checkbox"/>	<input type="checkbox"/>	<input type="checkbox"/> ★																																																																																																																																								
	14"							<input type="checkbox"/>	<input type="checkbox"/>	<input type="checkbox"/>	<input type="checkbox"/>	<input type="checkbox"/> ★																																																																																																																																						
<input type="checkbox"/> Amputee Axle Plate																																																																																																																																																		
10. CAMBER ANGLE	<input type="checkbox"/> 2° <input type="checkbox"/> 4° <input type="checkbox"/> 6° <input type="checkbox"/> 8°																																																																																																																																																	
11. FRONT OF SEAT SLING TO FOOTREST	<input type="checkbox"/> 12.5" <input type="checkbox"/> 13.0" <input type="checkbox"/> 13.5" <input type="checkbox"/> 14.0" <input type="checkbox"/> 14.5" <input type="checkbox"/> 15.0" <input type="checkbox"/> 15.5" <input type="checkbox"/> 16.0" <input type="checkbox"/> 16.5" <input type="checkbox"/> 17.0"																																																																																																																																																	
HIGH MOUNT <input type="checkbox"/> 6.5" <input type="checkbox"/> 7.0" <input type="checkbox"/> 7.5" <input type="checkbox"/> 8.0" <input type="checkbox"/> 8.5" <input type="checkbox"/> 9.0" <input type="checkbox"/> 9.5" <input type="checkbox"/> 10.0" <input type="checkbox"/> 10.5" <input type="checkbox"/> 11.0" <input type="checkbox"/> 11.5" <input type="checkbox"/> 12.0"	<small>*Measurement must be 2.0" shorter than your Front Seat Height</small>																																																																																																																																																	
12. INSIDE WHEEL CLEARANCE	<input type="checkbox"/> 3/4" * <input type="checkbox"/> 1" * <input type="checkbox"/> 1 1/4" <input type="checkbox"/> 1 1/2" <input type="checkbox"/> 1 3/4" <input type="checkbox"/> 2"																																																																																																																																																	
	<small>*3/4" and 1" Inside wheel clearance not available with 2 degree camber.</small>																																																																																																																																																	
	<small>*3/4" and 1" Inside wheel clearance not available with armrest.</small>																																																																																																																																																	
NOTE	Little Dipper is a custom made wheelchair. If you would like to customize your Little Dipper beyond what is available on this order form please submit your request here. Colours will determine as to whether this request can be accomplished while maintaining the safety and integrity of the wheelchair. If it can be accomplished the quote will reflect any and all custom charges, thank you.																																																																																																																																																	

1. SEAT WIDTH

Measure from outside of seat tube to the outside of the opposite seat tube.

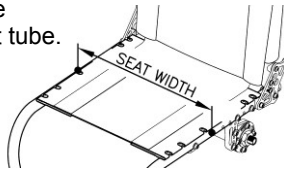

2. SEAT DEPTH

Measure from at the front bottom of backrest tube to the front edge of seat sling.

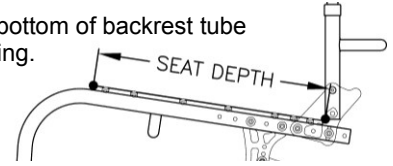

3. FOOTREST WIDTH

Measure from inside of front frame tube to inside of opposite front frame tube.

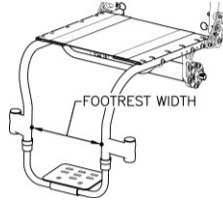

4. FRAME ANGLE

Measure angle frame front to floor.

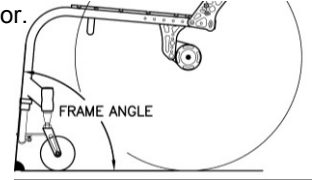

5. BACKREST HEIGHT

Measure from top of back post to seat sling at front bottom of backrest tube.

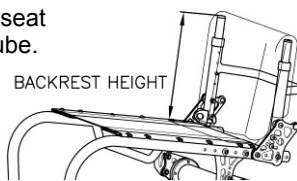

6. BACKREST ANGLE

Measure angle from front of back post to floor.

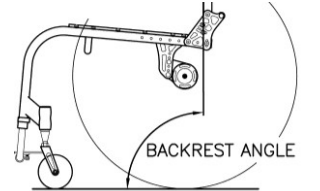

7. FRONT SEAT HEIGHT

Measure from floor to top of seat sling at front edge.

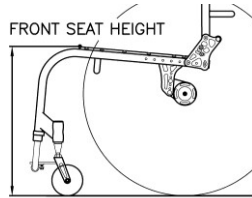

8. REAR SEAT HEIGHT

Measure from floor to top of seat sling at front bottom of backrest tube.

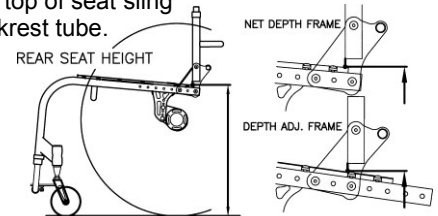

9. CENTER OF GRAVITY

Measure from center of back tube at the folding pivot to the center of the rear axle.

(If welding backrest is selected, Measure from center of back tube at the seat tube to the center of the rear axle.)

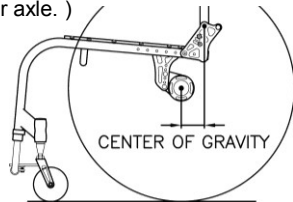

10. CAMBER ANGLE

Measure angle from wheel to vertical at floor.

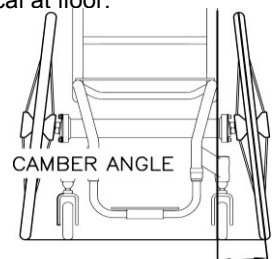

11. FRONT OF SEAT SLING TO FOOTREST

ADULT CHAIR

Measure from top of seat sling at front edge to top of foot plate at front edge.

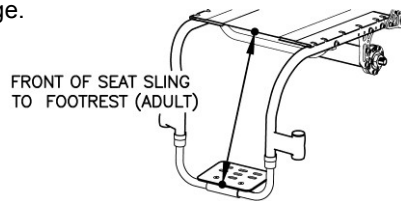

PEDIATRIC CHAIR

Measure vertical from top of seat sling at front edge to top of foot plate.



12. INSIDE WHEEL CLEARANCE

Measure from outside of seat back tube to inside of rear tire.

(If side guards are selected, measure from outside of side guards to inside of rear tire.)

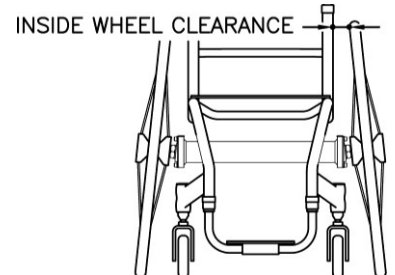

C SPECIAL PARTS COLORS (Please allow an additional 1-2 weeks delivery)

PARTS COLORS						
Powder-Coated	Gloss Black	Twilight Flake	Yellow	Magenta	Fire Engine Red	White
Neon Yellow	Candy Blue	Candy Purple	Candy Green	Candy Red	Candy Raspberry	Cobalt Blue
Brass Metallic	Matte Gray	Matte Purple	Matte Blue	Matte Green	Matte Black	Matte Red
Sparkle Burgundy	Neon Red	Neon Green	Orange Sparkle	Mellon Yellow	Gun Smoke Silver	Shocker Yellow
Tiffany Blue		Granny Sparkle Green	Sparkle Sky Blue	Reed Green	Blue Lilac	Blue Lilac
Special Colors	Polished Aluminum 24 karat Gold Plated					

Please Choose the Color for each Part
 *Parts not selected will be black color. (Suspension Spring: Silver Color)
 *Minimum 3 parts selected per order.

*PC=Powder-Coated

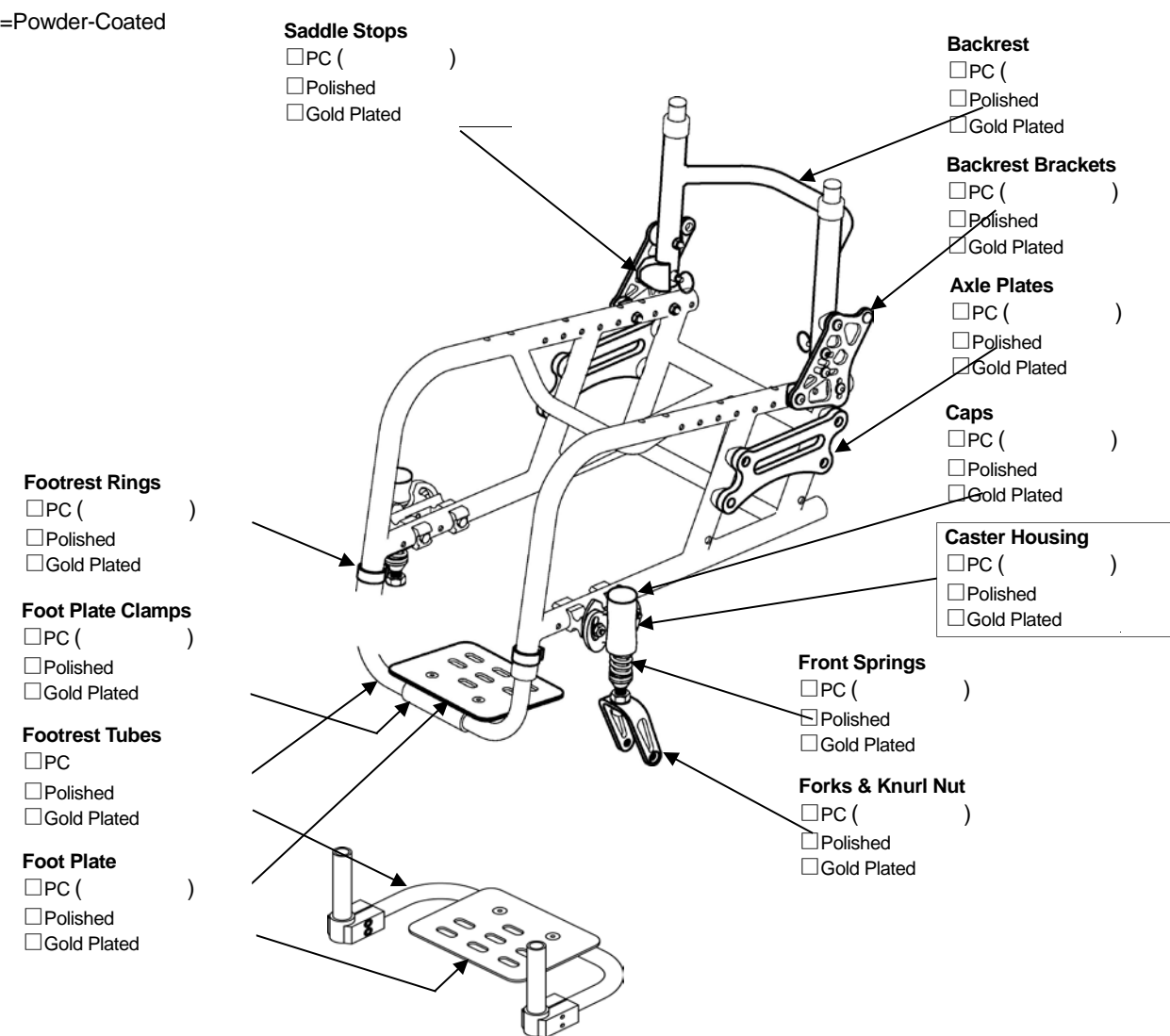

Valid from 2022. Prices & Specifications Are Subject To Change Without Notice.

D COMPONENTS

WHEEL LOCKS

New Solutions Push to Lock w/ 2" Extension Handle (\$80 up charge)

Gallop Push to Lock / Anodized

Question Mark Style Scissor

NEW Compact Scissor Lock / Anodized Black Only

Gallop Scissor Lock / Anodized

PUSH HANDLES *If you are ordering push handles, You must select the backrest locking mechanism.

Integrated w/Fixed Backrest Height / Anodized Black Only

Bolt-on / Anodized Black Only Specify Height from floor -()

Bolt-on w/Quick Release / Anodized Black Only Specify Height from floor -()

NEW Height Adj. / Anodized Black Only Specify Maximum height from floor -()

NEW ARM RESTS Anodized Black Only

Fixed Tubular Armrest Adj. Angle and Height Height from seat sling Set at : 8" 9" 10" 11" 12" **E0973**

Swing Away Tubular Armrest Adj. Angle and Height Height from seat sling Set at : 8" 9" 10" 11" 12" **E0973**

Flip-Up Armrest w/Fixed Tubular Armrest Height from seat sling Set at : 8" 9" 10" 11" 12" **E0973**
Adj. Angle w/ Swing Away Tubular Armrest Height from seat sling Set at : 8" 9" 10" 11" 12" **E0973**

Custom Length & Height (\$150 up charge)
*Specify Height & Length →

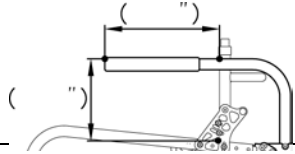

ANTI-TIPPERS

Removable Anti-tipper(pair) Anodized Black Only **E0971**

Press Release Removable Anti-tipper(pair) **E0971**

SIDE GUARDS

Rigid Side Guards - Black ABS Non-Removable Removable Removable w/Hole (\$12 up charge)
Color: Black Only Size: STD Medium Cut to Wheel (\$98 up charge) Measurement

Rigid Side Guards - Aluminum Non-Removable Removable
Size: Medium Only Cut to Wheel (\$98 up charge) Measurement
Color Black (STD) Pol. Aluminum (STD)
 Powder Coated () (\$120 up charge)
 Gold Plate (+CFP)

Height	Size
7.5"	STD
8.25"	Medium

Fabric Clothing Guards Black Nylon w/Velcro

SEAT CUSHION -*Please see section for other cushion choices.-

Foam Cushion w/Nylon Black Cover Thickness 1" 2" 3" 4"

Custom Cushion Cover (Std. Foam Cushion Only) -Select Fabric () (\$90 up charge)

ACCESSORIES

Frame Protectors / Black Leather/Zipper Type

Gel Ovation Protector Wraps Gel Silicone

E0978 Seat Belt w/Auto Buckle (BP) 1.5" Black Belt Only **E0978**

Tie Down Brackets 4pcs.

Calf Strap Black Matching Fabric (\$55 up charge) -Select Fabric ()

Bodypoint Padded Calf Strap (14"-16" footrest width) \$77 (16"-20" footrest width) \$83 (20"-24" footrest width) \$89

Hanging Zipper Pouch Black Matching Fabric (\$60) or Leather (\$75) Custom Size Width: Length:

Matching Fabric on Padded Side Guards -Select Fabric ()

UPHOLSTERY CHOICE & COLOR *Positioning Back Available. Please see Section E

Standard Adjustable Height Backrest (Black)

Adjustable Tension Backrest Black Only (*Not available with 8" Backrest Height)

Options Fun Fabric: For Std. or Adj. Style
(Choose From Choices on Page 7 and write below) (\$ 80 up charge)

Backrest Leather Trim (outside panels) (\$ up charge)

FABRIC CHOICE SHEET

1. Camouflage Girls

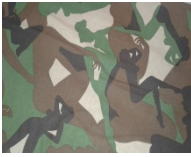

2. Purple Zebra



3. Silver Grey Snake



5. Laughing Skulls



6. Purple Snake



7. Sweetheart Pinup Girls



9. Blue Flames

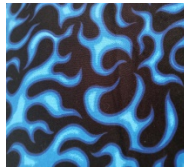

10. Arctic Camo



11. Furry Friends



12. Supercars



13. Urban Camo

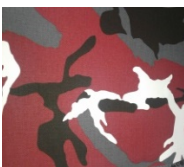

14. Superbikes



15. Sizzle Flames



16. Hot Rod Flames



17. Skulls w/ Attitude



18. Sweet Pink



19. Heart and Soul



20. Home Run



21. Fuzzy Giraffe

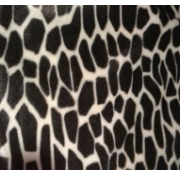

22. Cheetah



23. Paperweight Cobalt



24. Zig Zag Dots



25. Smokey Tribal Flames



26. Rose and Rebellion



27. Tattoo Adventure(Cream

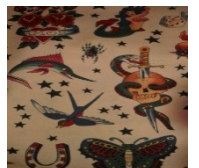

28. Red Tribal Flames

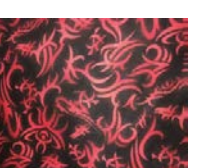

29. Tattoo Adventure(Black)

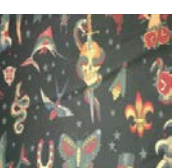

30. Butterfly Bandana

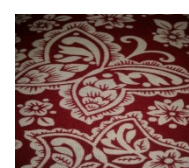

31. Tatsu Dragon

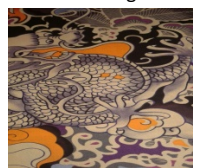

E TIRES, CASTERS, & FORKS

TIRES	
<input type="checkbox"/> Low Pressure Tire Only	<input type="checkbox"/> 20"x1-3/8" or <input type="checkbox"/> 22"x1-3/8" Gray E2211/E2212
<input type="checkbox"/> Primo High Pressure Tire	<input type="checkbox"/> 20 x 1(451) E2211/E2212
<input type="checkbox"/> 22"x1"(501) Gray Tire with black wall Only	
<input type="checkbox"/> Solid Tire	<input type="checkbox"/> 20"x1" (451) <input type="checkbox"/> Dark Gray <input type="checkbox"/> 22 x 1 <input type="checkbox"/> Black Only(\$30) E2218
<input type="checkbox"/> E2213 Flat-Free Inserts	For 20"x1-3/8" or 22"x1-3/8" Tires Only E2211/E2213
<input type="checkbox"/> Schwalbe Marathon Plus High Pressure Tire	<input type="checkbox"/> 22 x 1

CASTERS		SIZE	TIRE WIDTH	HUB COLOR	TIRE COLOR	DESCRIPTION
<input type="checkbox"/>	3"	1"	Black Hub	Black Tire Only	Polyurethane	
<input type="checkbox"/>	3"	1"	Plastic Black Hub	Clear Tire Only	Lighted, Polyurethane	
<input type="checkbox"/>	3"	1"	Red Hub	Red Tire Only	Polyurethane	
<input type="checkbox"/>	3"	1"	Black Hub	Clear Tire Only	Polyurethane	
<input type="checkbox"/>	3"	1"	Aluminum Silver Hub	Black Tire Only	Made By Frog Legs	
<input type="checkbox"/>	3"	1"	Aluminum Black Hub	Black Tire Only	Made By Frog Legs	
<input type="checkbox"/>	3"	1.5"	Aluminum Silver Hub	Black Tire Only	Soft Roll Made By Frog Legs	
<input type="checkbox"/>	3"	1.5"	Aluminum Black Hub	Black Tire Only	Soft Roll Made By Frog Legs	
<input type="checkbox"/>	4"	1 1/8"	Plastic Black Hub	Black Tire Only	Polyurethane E2222	
<input type="checkbox"/>	4"	1"	Plastic Black Hub	Clear Only	Lighted, Polyurethane	
<input type="checkbox"/>	4"	1"	Aluminum Silver Hub	Black Tire Only	Made By Frog Legs	
<input type="checkbox"/>	4"	1"	Aluminum Black Hub	Black Tire Only	Made By Frog Legs	
<input type="checkbox"/>	4"	1.5"	Aluminum Silver Hub	Tire <input type="checkbox"/> Black <input type="checkbox"/> Blue <input type="checkbox"/> Red	Soft Roll Made By Frog Legs	
<input type="checkbox"/>	4"	1.5"	Aluminum Black Hub	Black Tire Only	Soft Roll Made By Frog Legs	
<input type="checkbox"/>	5"	1"	Composite Black Hub	Black Tire Only		
<input type="checkbox"/>	5"	1"	Plastic Black Hub	Clear Tire Only	Lighted, Polyurethane	
<input type="checkbox"/>	5"	1"	Aluminum Silver Hub	Black Tire Only	Made By Frog Legs	
<input type="checkbox"/>	5"	1"	Aluminum Black Hub	Black Tire Only	Made By Frog Legs	
<input type="checkbox"/>	5"	1.5"	Aluminum Silver Hub	Tire <input type="checkbox"/> Black <input type="checkbox"/> Blue <input type="checkbox"/> Red	Soft Roll Made By Frog Legs	
<input type="checkbox"/>	5"	1.5"	Aluminum Black Hub	Black Tire Only	Soft Roll Made By Frog Legs	
<input type="checkbox"/>	"	<input type="checkbox"/> 1"OR <input type="checkbox"/> 1.5"	Hub Color:	Tread Color:	Soft Roll Made By Frog Legs	

FORKS		<input type="checkbox"/> Frog Leg Shields(4 pcs) Only for FrogLeg Forks
<input type="checkbox"/> STD Aluminum Forks	Black Only
Extra Options for Aluminum Forks	<input type="checkbox"/> With Suspension E1015
	<input type="checkbox"/> With Quick Release Axles K0073
<input type="checkbox"/> Frog Leg Suspension Forks Std 1" Wide	(For 3", 4" x 1" width Caster and 5" lighted) (Not available with Quick Release Axles)	
User's Color	<input type="checkbox"/> Anodized Black <input type="checkbox"/> Anodized Silver Or STD 4" x 1 1/8" Casters) E1015
<input type="checkbox"/> Frog Leg Suspension Forks 1.5" Wide	(For 3", 4" x 1.5" width Caster and 5" Caster) (Not available with Quick Release Axles)	
User's Color	<input type="checkbox"/> Anodized Black <input type="checkbox"/> Anodized Silver E1015

Valid from 2022 Prices & Specifications Are Subject To Change Without Notice.

F WHEELS

WHEELS

Wire Wheels

20" (451) 22" (501)

**Spinergy Spox
18 Spokes**



22" (501) 22" (501)

Spoke Color Black Red Yellow Blue White

With Silver Hub With Black Hub With Black Hub With Black Hub With Black Hub

Custom Color Spoke Pattern

		Left Wheel	Right Wheel
Spokes Color	Inside		
	Outside		
Hub Color		<input type="checkbox"/> Black/ <input type="checkbox"/> Silver	<input type="checkbox"/> Black/ <input type="checkbox"/> Silver

.

**Spinergy LX
12 Spokes**



22" (501)

Spoke Color Black Red Yellow Blue

With Silver Hub With Black Hub With Black Hub With Black Hub

White Neon Green Pink Orange

With Black Hub With Black Hub With Black Hub With Black Hub

Purple With Black Hub

Custom Color Spoke Pattern

		Left Wheel	Right Wheel
Spokes Color	Inside		
	Outside		
Hub Color		<input type="checkbox"/> Black/ <input type="checkbox"/> Silver	<input type="checkbox"/> Black/ <input type="checkbox"/> Silver

.

HANDRIMS

Type

Standard For 20" & 22" Wheel Anodized Silver

Vinyl Coated For 20" & 22" Wheel

Spinergy Silver Brushed Anodized For 24", 25" & 26" Wheels

Natural Fit For 22" Wheel Only

- Standard Grip (Not available with short tabs.)
- Super Grip (Not available with short tabs.)
- Without Thumb Grip

Natural Fit (LT) For 22" Wheel Only

- Standard Grip (Not available with short tabs.)
- Super Grip (Not available with short tabs.)
- Without Thumb Grip

The Surge Handrims

The Surge Handrims (LT)

The Q-Grip Handrims : anti-slip, latex-free, neoprene coating. 22" Only

OMIT HANDRIMS

TAB LENGTH

Long Tabs (STD inside clearance 3/4") *

Short Tabs (Inside clearance 1/2") * Not available with Natural Fit Handrim with thumb grip

Short Tab (Set closest to wheel cut off excess)

G CHAIR OPTIONS 1/3

SEAT CUSHION	
SUPRACOR® WHEELCHAIR CUSHIONS	
Stimulite® Contoured Cushion *Black Upholstery only *Comes with Zipper Pouch <input type="checkbox"/> Extra Cover (\$104 up charge)	<input type="checkbox"/> W14"xD16" (CD1416) E2603 <input type="checkbox"/> W16"xD16" (CD1616) E2603 <input type="checkbox"/> Extra Sensitive (\$35 up charge) <input type="checkbox"/> Sling Style Bottom (\$452up) <input type="checkbox"/> Custom Size (\$ CFP) W(") x D(")
Stimulite® Slimline Cushion *Black Upholstery only <input type="checkbox"/> Extra Cover (\$75 up charge) <input type="checkbox"/> Custom Size (\$- CFP)	<input type="checkbox"/> W14"xD16" (SM1416) E2603 <input type="checkbox"/> W16"xD16" (SM1616) E2603 <input type="checkbox"/> Extra Sensitive (\$35 up charge) <input type="checkbox"/> Sling Style Bottom (\$52 up charge)
Stimulite® Corbee Pediatric Cushion *Black Upholstery only <input type="checkbox"/> Extra Cover (\$75 up charge)	<input type="checkbox"/> W10"xD10" (PD1010) E2603 <input type="checkbox"/> W12"xD12" (PD1212) E2603 <input type="checkbox"/> W14"xD14" (PD1414) E2603 <input type="checkbox"/> Extra Sensitive (\$35 up charge) <input type="checkbox"/> Sling Style Bottom (\$52 up charge) <input type="checkbox"/> Custom Size W(") x D(") (\$CFP)
ROHO WHEELCHAIR CUSHIONS	
<input type="checkbox"/> 4" HIGH PROFILE® QUADTRO SELECT® CUSHION *Black Upholstery <input type="checkbox"/> Extra Cover (+\$57) E2622-2623 Choose Size <input type="checkbox"/> W12"xD12" <input type="checkbox"/> W12"xD13" <input type="checkbox"/> W13"xD13" <input type="checkbox"/> W13"xD15" <input type="checkbox"/> W13"xD16" <input type="checkbox"/> W15"xD13" <input type="checkbox"/> W15"xD15" <input type="checkbox"/> W15"xD16" <input type="checkbox"/> W15"xD18" <input type="checkbox"/> W16"xD15"	<input type="checkbox"/> Custom Size W(") x D(") (\$CFP)
<input type="checkbox"/> 3" MID PROFILE® QUADTRO SELECT® CUSHION *Black Upholstery only <input type="checkbox"/> Extra Cover (+\$57) E2622-2623 Choose Size <input type="checkbox"/> W12"xD12" <input type="checkbox"/> W12"xD13" <input type="checkbox"/> W13"xD13" <input type="checkbox"/> W13"xD15" <input type="checkbox"/> W13"xD16" <input type="checkbox"/> W15"xD13" <input type="checkbox"/> W15"xD15" <input type="checkbox"/> W15"xD16" <input type="checkbox"/> W15"xD18" <input type="checkbox"/> W16"xD15" <input type="checkbox"/> W16"xD16"	<input type="checkbox"/> Custom Size W(") x D(") (\$CFP)
<input type="checkbox"/> 2" LOW PROFILE® QUADTRO SELECT® CUSHION *Black Upholstery only <input type="checkbox"/> Extra Cover (+\$57) E2622-2623 Choose Size <input type="checkbox"/> W12"xD12" <input type="checkbox"/> W12"xD13" <input type="checkbox"/> W13"xD13" <input type="checkbox"/> W13"xD15" <input type="checkbox"/> W13"xD16" <input type="checkbox"/> W15"xD13" <input type="checkbox"/> W15"xD15" <input type="checkbox"/> W15"xD16" <input type="checkbox"/> W15"xD18" <input type="checkbox"/> W16"xD15" <input type="checkbox"/> W16"xD16"	<input type="checkbox"/> Custom Size W(") x D(") (\$CFP)
STAR CUSHIONS	
Galaxy Cushion *Black Upholstery only <input type="checkbox"/> W14"xD14" (GXY 1414-2) <input type="checkbox"/> W14"xD16" (GXY 1416-2) <input type="checkbox"/> W16"xD14" (GXY 1614-2) <input type="checkbox"/> W16"xD16" (GXY 1616-2)	Choose Zoning Options E2624 <input type="checkbox"/> Standard - Dual Valve <input type="checkbox"/> Dual Valve - Front to Back <input type="checkbox"/> Four Valve <input type="checkbox"/> Simple - Single Valve <input type="checkbox"/> Four Valve - Enhanced <input type="checkbox"/> Four Valve - Front to Back
THE CURVE CUSHION	<input type="checkbox"/> W10"xD10" <input type="checkbox"/> W10"xD11" <input type="checkbox"/> W10"xD11" <input type="checkbox"/> W10"xD12" <input type="checkbox"/> W11"xD12" <input type="checkbox"/> W12"xD12" *Black Upholstery only <input type="checkbox"/> W12"xD13" <input type="checkbox"/> W12"xD14" <input type="checkbox"/> W13"xD11" <input type="checkbox"/> W13"xD12" <input type="checkbox"/> W13"xD13" <input type="checkbox"/> W13"xD14" <input type="checkbox"/> Extra Cover (+\$40) <input type="checkbox"/> W14"xD14" <input type="checkbox"/> W14"xD15" <input type="checkbox"/> W14"xD16" <input type="checkbox"/> W15"xD14" <input type="checkbox"/> W15"xD15" <input type="checkbox"/> W15"xD16" <input type="checkbox"/> W16"xD14" <input type="checkbox"/> W16"xD15" <input type="checkbox"/> W16"xD16"

Valid from 2022 Prices & Specifications Are Subject To Change Without Notice.

G CHAIR OPTIONS 2/3

SEAT CUSHION	
Exgel Kaji Cushion	
For Comfortable Sitting To Prevent Pressure Sores	
<input type="checkbox"/> Owl Regular(1.6" Thick) Incontinence Cover Only	<input type="checkbox"/> W14"xD16" E2603 <input type="checkbox"/> W15"xD16" E2603 <input type="checkbox"/> W16"xD16" E2603 <input type="checkbox"/> W18"xD16" * No Custom Sizes E2603
<input type="checkbox"/> Owl High(3.1" Thick) Incontinence Cover Only	<input type="checkbox"/> W14"xD16" E2603 <input type="checkbox"/> W15"xD16" E2603 <input type="checkbox"/> W16"xD16" E2603 <input type="checkbox"/> W18"xD16" E2603 <input type="checkbox"/> W18"xD18" * No Custom Sizes E2603
<input type="checkbox"/> Owl Contour(4.3" Thick) Incontinence Cover Only	<input type="checkbox"/> W14"xD16" E2603 <input type="checkbox"/> W15"xD16" E2603 <input type="checkbox"/> W16"xD16" E2603 <input type="checkbox"/> W18"xD16" E2603 <div style="text-align: right;">* No Custom Sizes</div>
<input type="checkbox"/> Owl Deep Contour(4.3" Thick) <input type="checkbox"/> W14"xD16" \$ 458 * No Custom Sizes- Incontinence Cover Only <input type="checkbox"/> W14"xD16" \$518 <input type="checkbox"/> W15"xD16" \$518 <input type="checkbox"/> W16"xD16" \$518 <input type="checkbox"/> W18"xD16" \$558	
<input type="checkbox"/> Standard Regular(1.4" Thick) Easy to Use Flat Style (superior pressure redistribution) .. For Pressure Relief E2622-2623 <input type="checkbox"/> W12" x D12" \$368 <input type="checkbox"/> W13" x D13" \$368 <input type="checkbox"/> W14" x D14" \$368 <input type="checkbox"/> W14" x D16" \$368 <input type="checkbox"/> W16" x D16" \$368 <input type="checkbox"/> W16" x D17" \$368 <input type="checkbox"/> W17" x D16" \$368 <input type="checkbox"/> W17" x D17" \$368 <input type="checkbox"/> W18" x D16" \$391 <input type="checkbox"/> W18" x D18" \$391 <input type="checkbox"/> W18" x D19" \$440 <input type="checkbox"/> W18" x D20" \$440 <input type="checkbox"/> W19" x D19" \$440 <div style="text-align: right;">* No Custom Sizes- Incontinence Cover Only</div>	
<input type="checkbox"/> Standard High(2.6" Thick) Incontinence Cover Only E2622 *Black Upholstery only <input type="checkbox"/> W12" x D12" \$383 <input type="checkbox"/> W13" x D13" \$ 383 <input type="checkbox"/> W14" x D14" \$383 <input type="checkbox"/> W14" x D16" \$ 383 <input type="checkbox"/> W16" x D16" \$383 <input type="checkbox"/> W16" x D17" \$383 <input type="checkbox"/> W17" x D16" \$383 <input type="checkbox"/> W17" x D17" \$383 <input type="checkbox"/> W18" x D16" \$460 <input type="checkbox"/> W18" x D18" \$460 <input type="checkbox"/> W18" x D19" \$512 <input type="checkbox"/> W18" x D20" \$512 <input type="checkbox"/> W19" x D19" \$512 <input type="checkbox"/> W18" x D19" \$512	
<input type="checkbox"/> Standard Anti-Thrust(2.6" Thick) * No Custom Sizes Incontinence Cover Only	<input type="checkbox"/> W16 x D16 \$460 Prevents Unwanted <input type="checkbox"/> W18 x D16 \$500 Forward Movement of <input type="checkbox"/> W18 x D18 \$500 lower back and hip bone
<input type="checkbox"/> Lite Regular(2.2" Thick) <input type="checkbox"/> W16" x D16" \$374 <input type="checkbox"/> W18" x D16" \$397 <input type="checkbox"/> W18" x D18" \$397 * No Custom Sizes- Incontinence Cover Only	
<input type="checkbox"/> Lite High(3.0" Thick) <input type="checkbox"/> W16" x D16" \$408 <input type="checkbox"/> W18" x D16" \$431 <input type="checkbox"/> W18" x D18" \$431 * No Custom Sizes- Incontinence Cover Only	

H CHAIR OPTIONS 3/3

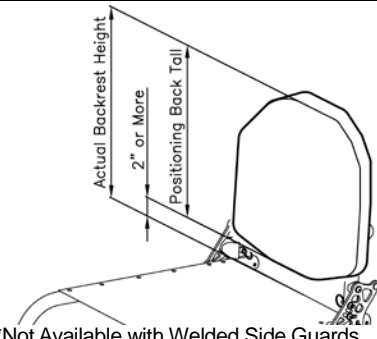
POSITIONING BACK																									
<p>*Note : Actual height of the backrest will increase 2" or more.</p> <div style="text-align: right;">  </div>																									
<p>ADI CARBON BACKREST (Support Contour-ACTIVE 2.5") *Not Available with Welded Side Guards</p> <p>Mounting Hardware: <input type="checkbox"/> 2 Point Pro <input type="checkbox"/> Quick Release</p> <table style="width:100%; border-collapse: collapse;"> <tr> <td style="width:15%; vertical-align: top;">Height</td> <td style="width:55%;"><input type="checkbox"/> LOW (10" Tall) *Backrest Height requires 12" or more</td> <td style="width:15%;">*Available 13"-19" width</td> <td style="width:15%;">Width (") E2613</td> </tr> <tr> <td></td> <td><input type="checkbox"/> Medium (13" Tall) *Backrest Height requires 15" or more</td> <td>*Available 13"-19" width</td> <td>Width (") E2613</td> </tr> <tr> <td><input type="checkbox"/> Add Privacy Flap (\$60 up charge)</td> <td><input type="checkbox"/> Standard (16" Tall) *Backrest Height requires 18" or more</td> <td>*Available 13"-19" width</td> <td>Width (") E2613</td> </tr> <tr> <td></td> <td><input type="checkbox"/> Custom Size (" Tall) x (" width)</td> <td colspan="2">. E2613</td> </tr> </table>		Height	<input type="checkbox"/> LOW (10" Tall) *Backrest Height requires 12" or more	*Available 13"-19" width	Width (") E2613		<input type="checkbox"/> Medium (13" Tall) *Backrest Height requires 15" or more	*Available 13"-19" width	Width (") E2613	<input type="checkbox"/> Add Privacy Flap (\$60 up charge)	<input type="checkbox"/> Standard (16" Tall) *Backrest Height requires 18" or more	*Available 13"-19" width	Width (") E2613		<input type="checkbox"/> Custom Size (" Tall) x (" width) E2613									
Height	<input type="checkbox"/> LOW (10" Tall) *Backrest Height requires 12" or more	*Available 13"-19" width	Width (") E2613																						
	<input type="checkbox"/> Medium (13" Tall) *Backrest Height requires 15" or more	*Available 13"-19" width	Width (") E2613																						
<input type="checkbox"/> Add Privacy Flap (\$60 up charge)	<input type="checkbox"/> Standard (16" Tall) *Backrest Height requires 18" or more	*Available 13"-19" width	Width (") E2613																						
	<input type="checkbox"/> Custom Size (" Tall) x (" width) E2613																							
<p>ADI ALUMINUM BACKREST (Support Contour-ACTIVE 2.5") *Not Available with Welded Side Guards</p> <p>Mounting Hardware: <input type="checkbox"/> 2 Point Pro <input type="checkbox"/> Quick Release</p> <table style="width:100%; border-collapse: collapse;"> <tr> <td style="width:15%; vertical-align: top;">Height</td> <td style="width:55%;"><input type="checkbox"/> LOW (10" Tall) *Backrest Height requires 12" or more</td> <td style="width:15%;">*Available 10"-20" width</td> <td style="width:15%;">Width (") E2613</td> </tr> <tr> <td></td> <td><input type="checkbox"/> Medium (13" Tall) *Backrest Height requires 15" or more</td> <td>*Available 12"-20" width</td> <td>Width (") E2613</td> </tr> <tr> <td></td> <td><input type="checkbox"/> Standard (16" Tall) *Backrest Height requires 18" or more</td> <td>*Available 14"-20" width</td> <td>Width (") E2613</td> </tr> <tr> <td></td> <td><input type="checkbox"/> Tall (18" Tall) *Backrest Height requires 20" or more</td> <td>*Available 16"-20" width</td> <td>Width (") E2613</td> </tr> <tr> <td><input type="checkbox"/> Add Privacy Flap (\$60 up charge)</td> <td><input type="checkbox"/> X-Tall (20" Tall) *Backrest Height requires 22" or more</td> <td>*Available 16"-20" width</td> <td>Width (") E2613</td> </tr> <tr> <td></td> <td><input type="checkbox"/> Custom Size (" Tall) x (" width)</td> <td colspan="2">. E2613</td> </tr> </table>		Height	<input type="checkbox"/> LOW (10" Tall) *Backrest Height requires 12" or more	*Available 10"-20" width	Width (") E2613		<input type="checkbox"/> Medium (13" Tall) *Backrest Height requires 15" or more	*Available 12"-20" width	Width (") E2613		<input type="checkbox"/> Standard (16" Tall) *Backrest Height requires 18" or more	*Available 14"-20" width	Width (") E2613		<input type="checkbox"/> Tall (18" Tall) *Backrest Height requires 20" or more	*Available 16"-20" width	Width (") E2613	<input type="checkbox"/> Add Privacy Flap (\$60 up charge)	<input type="checkbox"/> X-Tall (20" Tall) *Backrest Height requires 22" or more	*Available 16"-20" width	Width (") E2613		<input type="checkbox"/> Custom Size (" Tall) x (" width) E2613	
Height	<input type="checkbox"/> LOW (10" Tall) *Backrest Height requires 12" or more	*Available 10"-20" width	Width (") E2613																						
	<input type="checkbox"/> Medium (13" Tall) *Backrest Height requires 15" or more	*Available 12"-20" width	Width (") E2613																						
	<input type="checkbox"/> Standard (16" Tall) *Backrest Height requires 18" or more	*Available 14"-20" width	Width (") E2613																						
	<input type="checkbox"/> Tall (18" Tall) *Backrest Height requires 20" or more	*Available 16"-20" width	Width (") E2613																						
<input type="checkbox"/> Add Privacy Flap (\$60 up charge)	<input type="checkbox"/> X-Tall (20" Tall) *Backrest Height requires 22" or more	*Available 16"-20" width	Width (") E2613																						
	<input type="checkbox"/> Custom Size (" Tall) x (" width) E2613																							
<p>ADI ALUMINUM BACKREST (Support Contour-DEEP 4") *Not Available with Welded Side Guards *Not Available with Lateral Supports</p> <p>Mounting Hardware: <input type="checkbox"/> 2 Point Pro <input type="checkbox"/> Quick Release</p> <table style="width:100%; border-collapse: collapse;"> <tr> <td style="width:15%; vertical-align: top;">Height</td> <td style="width:55%;"><input type="checkbox"/> LOW (10" Tall) *Backrest Height requires 12" or more</td> <td style="width:15%;">*Available 10"-20" width</td> <td style="width:15%;">Width (") E2615</td> </tr> <tr> <td></td> <td><input type="checkbox"/> Medium (13" Tall) *Backrest Height requires 15" or more</td> <td>*Available 12"-20" width</td> <td>Width (") E2615</td> </tr> <tr> <td></td> <td><input type="checkbox"/> Standard (16" Tall) *Backrest Height requires 18" or more</td> <td>*Available 14"-20" width</td> <td>Width (") E2615</td> </tr> <tr> <td></td> <td><input type="checkbox"/> Tall (18" Tall) *Backrest Height requires 20" or more</td> <td>*Available 16"-20" width</td> <td>Width (") E2615</td> </tr> <tr> <td><input type="checkbox"/> Add Privacy Flap (\$60 up charge)</td> <td><input type="checkbox"/> X-Tall (20" Tall) *Backrest Height requires 22" or more</td> <td>*Available 16"-20" width</td> <td>Width (") E2615</td> </tr> <tr> <td></td> <td><input type="checkbox"/> Custom Size (" Tall) x (" width)</td> <td colspan="2">. E2615</td> </tr> </table>		Height	<input type="checkbox"/> LOW (10" Tall) *Backrest Height requires 12" or more	*Available 10"-20" width	Width (") E2615		<input type="checkbox"/> Medium (13" Tall) *Backrest Height requires 15" or more	*Available 12"-20" width	Width (") E2615		<input type="checkbox"/> Standard (16" Tall) *Backrest Height requires 18" or more	*Available 14"-20" width	Width (") E2615		<input type="checkbox"/> Tall (18" Tall) *Backrest Height requires 20" or more	*Available 16"-20" width	Width (") E2615	<input type="checkbox"/> Add Privacy Flap (\$60 up charge)	<input type="checkbox"/> X-Tall (20" Tall) *Backrest Height requires 22" or more	*Available 16"-20" width	Width (") E2615		<input type="checkbox"/> Custom Size (" Tall) x (" width) E2615	
Height	<input type="checkbox"/> LOW (10" Tall) *Backrest Height requires 12" or more	*Available 10"-20" width	Width (") E2615																						
	<input type="checkbox"/> Medium (13" Tall) *Backrest Height requires 15" or more	*Available 12"-20" width	Width (") E2615																						
	<input type="checkbox"/> Standard (16" Tall) *Backrest Height requires 18" or more	*Available 14"-20" width	Width (") E2615																						
	<input type="checkbox"/> Tall (18" Tall) *Backrest Height requires 20" or more	*Available 16"-20" width	Width (") E2615																						
<input type="checkbox"/> Add Privacy Flap (\$60 up charge)	<input type="checkbox"/> X-Tall (20" Tall) *Backrest Height requires 22" or more	*Available 16"-20" width	Width (") E2615																						
	<input type="checkbox"/> Custom Size (" Tall) x (" width) E2615																							
<p>ADI LATERAL SUPPORTS (Lateral Supports are compatible with only active 2.5" ADI positioning back.)</p> <p><input type="checkbox"/> Stationary Pad Pad Size <input type="checkbox"/> Small (3" H x 3" D) <input type="checkbox"/> Medium(3" H x 4" D) <input type="checkbox"/> Large(4.5" H x 4.5" D) <input type="checkbox"/> Large(4" H x 6" D)</p> <p style="margin-left: 20px;"><input type="checkbox"/> Pair</p> <p style="margin-left: 20px;"><input type="checkbox"/> Left side only or <input type="checkbox"/> Right side only</p> <p><input type="checkbox"/> Swing-Out Pad Size <input type="checkbox"/> Small (3" H x 3" D) <input type="checkbox"/> Medium(3" H x 4" D) <input type="checkbox"/> Large(4.5" H x 4.5" D) <input type="checkbox"/> Large(4" H x 6" D)</p> <p style="margin-left: 20px;"><input type="checkbox"/> Pair</p> <p style="margin-left: 20px;"><input type="checkbox"/> Left side only or <input type="checkbox"/> Right side only</p>																									
OTHER																									
<input type="checkbox"/> ADI Transfer Board <input type="checkbox"/> 21" (ADV21) <input type="checkbox"/> 24" (ADV24) <input type="checkbox"/> 29" (ADV29)																									
<input type="checkbox"/> ADI Push and Transfer Gloves Leather (one size fits)																									
<input type="checkbox"/> ADI Carbon Solid Seat (Wide: 18" Max, Depth: 20") ✘ ONLY AVAILABLE WITH COLOURS NON-REMOVABLE SIDE GUARDS																									
<p>VARILITE® Seating Systems Available</p> <p style="text-align: right;">Please visit for all options. www.varilite.com</p>																									
<p>NOTE</p>																									