

ITEM# LM5BA

STATIONARY OXYGEN CONCENTRATOR



 RHYTHM



**Smoking while using oxygen is the number one cause of fire injuries and related deaths.
You must follow these safety warnings:**

Do not allow smoking, candles, or open flames in the same room with the device or within five feet of the oxygen-carrying accessories.

Smoking while wearing an oxygen cannula may cause facial burns and possibly death.

Removing the cannula and putting it on bedding, sofas, or other cushion material will cause a fire when exposed to a cigarette, heat source, or flame.

If you intend to smoke, you must always turn the oxygen concentrator off, remove the cannula and leave the room where either the cannula or mask or the oxygen concentrator is located. If unable to leave the room, you must wait 10 minutes after you have turned the oxygen concentrator off before smoking.

TABLE OF CONTENTS

IMPORTANT SAFEGUARDS _____	5, 6
CONTRAINDICATIONS FOR USE _____	7
IMPORTANT PARTS OF YOUR CONCENTRATOR _____	7-9
SETTING UP YOUR OXYGEN CONCENTRATOR _____	10
BEFORE OPERATING YOUR OXYGEN CONCENTRATOR _____	11
OPERATING YOUR CONCENTRATOR _____	12
CARING AND PERIODIC MAINTENANCE FOR YOUR UNIT _____	13
ALERT INDICATION SYSTEM _____	15
MINOR TROUBLESHOOTING _____	17
SPECIFICATIONS _____	18
SYMBOLS _____	19,20
ELECTROMAGNETIC INFORMATION _____	20,21
LIMITED WARRANTY _____	22

INTRODUCTION

INDICATIONS FOR USE: The Oxygen Concentrator is intended for use as an oxygen concentrator to provide supplemental low flow oxygen therapy for adult, geriatric and pediatric in the home, nursing homes, patient care facilities, etc. The pediatric must be treated under adult supervision. It is not intended to sustain or support life.
Patient group: Adult, geriatric and pediatric.



WARNING: Under certain circumstances, oxygen therapy can be hazardous.
Seeking medical advice before using an oxygen concentrator is advisable.

IMPORTANT SAFEGUARDS

Please read and understand this manual before operating your unit. Important safeguards are indicated throughout this guide.

Pay special attention to all safety information. If you have any questions, contact your provider.



WARNING: No modification of this equipment is permitted.

WARNING: For your safety, the oxygen concentrator must be used according to the prescription determined by your provider. If you feel any discomfort or are experiencing a medical emergency while undergoing oxygen therapy, seek medical assistance immediately to avoid harm.

WARNING: The device is not intended for life support. If the provider has determined that an interruption in the supply of oxygen, for any reason, may have serious consequences to the user, an alternate source of oxygen should be available for immediate use.

WARNING: It is the responsibility of the provider supplying the LM5BA to the patient to ensure that the device is used in a safe and effective manner in keeping with the provider's prescription for supplemental oxygen use. While this manual is intended to support this goal, ultimate determination of the patient's safety resides with the patient's provider.

WARNING: Availability of an alternate source of oxygen is required in case of power outage or mechanical failure. Back-up oxygen should be available (oxygen cylinders, etc.).

WARNING: Do not use your oxygen concentrator in the presence of flammable gases. This can result in rapid burning causing property damage, bodily injuries, or death. Do not use oil, grease, petroleum-based products or other flammable products with the oxygen-carrying accessories or the Oxygen Concentrator. Only water based, oxygen compatible lotions or salves should be used. Oxygen accelerates the combustion of flammable substances.

WARNING: Only use a mild detergent applied with a damp (not wet) cloth or sponge to clean the cabinet, control panel, and power cord and then wipe all surfaces dry. Do not allow any liquid to get inside the device. Pay special attention to the oxygen outlet for the cannula connection to make sure it remains free of dust, dirt, and particles.

WARNING: Do not operate unit in a restricted or confined space (i.e., a small case or handbag) where ventilation can be limited. This can cause the oxygen concentrator to overheat and impair performance.

WARNING: The oxygen concentrator should be located in an area away from smoke, pollutants or fumes



WARNING: The use of some oxygen administering accessories is not specified for this oxygen concentrator and may impair its performance. Recommended accessories are referenced in this manual.

WARNING: If the oxygen concentrator has been dropped, damaged, or exposed to water, please contact your provider for inspection or possible repair of the device. Do not use the oxygen concentrator if it has a damaged power cord or plug.

WARNING: Do not allow the air intake or air outlet vents to become blocked. Do not drop or insert any objects into any openings on the device. This can cause the oxygen concentrator to overheat and impair performance.

WARNING: Do not overfill the optional humidifier. Fill the optional humidifier with water only to the level shown by the manufacturer of the humidifier.

WARNING: If you feel any discomfort or are experiencing a medical emergency, seek medical assistance immediately.

WARNING: Operating the unit outside of the operational temperature specifications can limit the concentrator's ability to meet oxygen concentration specification. Refer to the specification section of this manual for temperature limits.

WARNING: The oxygen concentrator should not be used adjacent to or stacked with other equipment. If adjacent or stacked use is unavoidable, the device should be observed to verify normal operation.



In the event of an alarm or you observe the oxygen concentrator is not working properly; consult the troubleshooting section in this manual. If you cannot resolve the problem, consult your provider. To prevent voiding the warranty, follow the manufacturer's instructions.

WARNING: Do not attempt any maintenance other than the possible solutions listed within this manual. Do not remove covers. Only your equipment provider or a qualified service technician should remove the covers or service this device.

WARNING: Do not leave a nasal cannula on or under clothing, bed coverings or chair cushions. If the unit is turned on but not in use, the oxygen will make the material flammable. Turn the oxygen concentrator off when not in use.



Always disconnect AC power supply from the wall before disconnecting the AC power supply from the oxygen concentrator. Always place oxygen supply tubing and power cords in a manner that prevents a trip hazard.

CONTRAINDICATIONS FOR USE



WARNING: This device is not intended to be life-sustaining or life-supporting. This device is not intended for newborn or infant use.

Not for use in the presence of flammable anesthetics.

WARNING: The unit is not appropriate for any patient who would experience adverse healthcare consequences as the result of such temporary interruption.

IMPORTANT PARTS OF YOUR CONCENTRATOR

Please take time to familiarize yourself with your oxygen concentrator before operating.

Packing list. Ensure you have the following items:

- 1 x User manual
- 1 x Oxygen concentrator set
- 1 x Oxygen Outlet Connector
- 1 x Humidifier (Optional)
- 1 x Adapter for humidifier (Optional)

If used, clean your humidifier daily to reduce the possibility of contamination. Follow the cleaning recommendations from your provider, or the manufacturer of the humidifier. Replace the humidifier every 2-6 months, or as recommended by the manufacturer, or your home care provider. Do not overfill the humidifier.



WARNING: Accessories designed by other manufacturers have not been tested by Rhythm Healthcare and are not recommended for use with Rhythm Healthcare products.

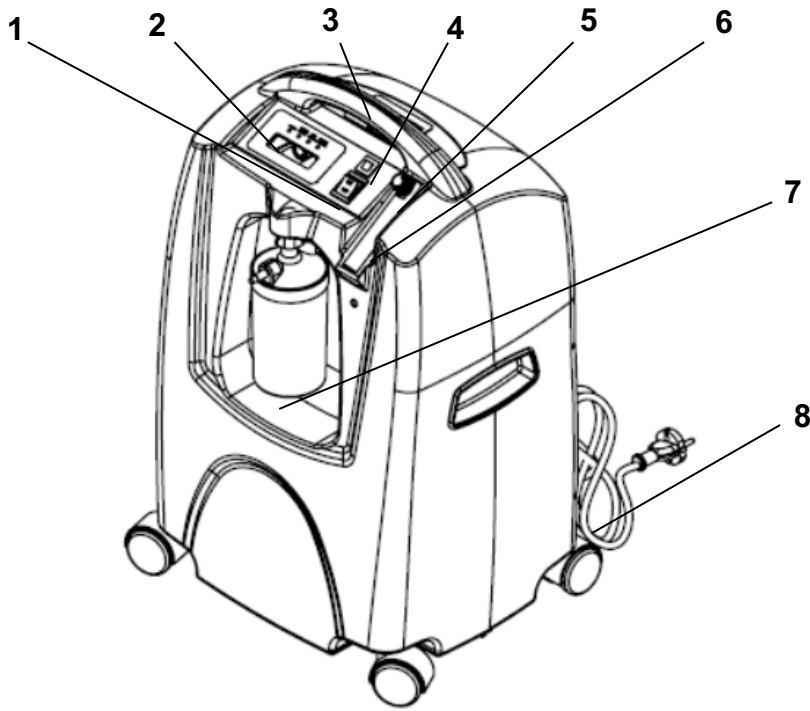

Figure 1

1. Power Switch

Push to switch on, then the unit turns on. Push switches it off, the unit stops.

I = ON O = OFF

2. Monitor - Indicates system pressure status.

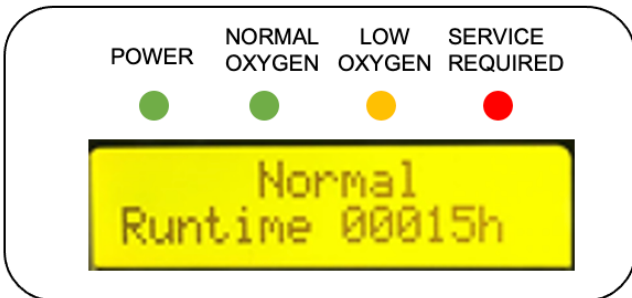

Figure 2

Displays when the device runs. There are four indication lights on the panel.

- Green indicator light = Power on
- Green indicator light = Normal oxygen, O₂ over 82%
- Yellow indicator light = Low Oxygen, O₂ less than 82%
- Red indicator light = Service required. Please turn of the unit and contact the provider.

3. Operating instructions

Operating warnings label:



1, DO NOT OPERATE THIS EQUIPMENT WITHOUT FIRST READING AND UNDERSTANDING THIS MANUAL, IF YOU ARE UNABLE TO UNDERSTAND THE WARNINGS AND INSTRUCTIONS, CONTACT YOUR EQUIPMENT PROVIDER BEFORE ATTEMPTING TO USE THIS EQUIPMENT; TOHERWISE, INJURY OR DAMAGE MAY RESULT.

2, Under certain circumstances, oxygen therapy can be hazardous. Seeking medical advice before using an oxygen concentrator is advisable.

3, NO SMOKING - Keep ALL sources of ignition out of the room in which this product is located and away from areas where oxygen is being delivered. Textiles, oils, and other combustibles are easily ignited and burn with great intensity in oxygen enriched air.

4, RISK OF ELECTRIC SHOCK Do not remove cover. Refer servicing to qualified service personnel.

4. Circuit breaker – (selected units) resets the unit after electrical power outage or overload.

5. Flow meter knob

6. Flow meter

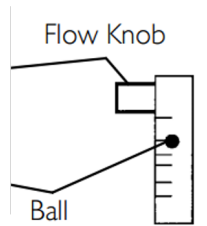

F e 3

SELECTING FLOW RATE: Turn the flow rate knob to the setting prescribed by your provider. We recommend the flowrate between 1.5L/min - 5L/min.

TO PROPERLY READ THE FLOW METER: Locate the prescribed flowrate line on the flowmeter. Next, turn the flow knob until the ball rises to the line. Now, center the ball on the L/min. line prescribed.

CAUTION:

Never set the flow greater than 5L/min.

7. Humidifier (optional)

8. Power cord

Back View

9. Cover

10. Air filter prevents dirt, dust, and lint from entering

11. Specification Label

12. Exhaust vent

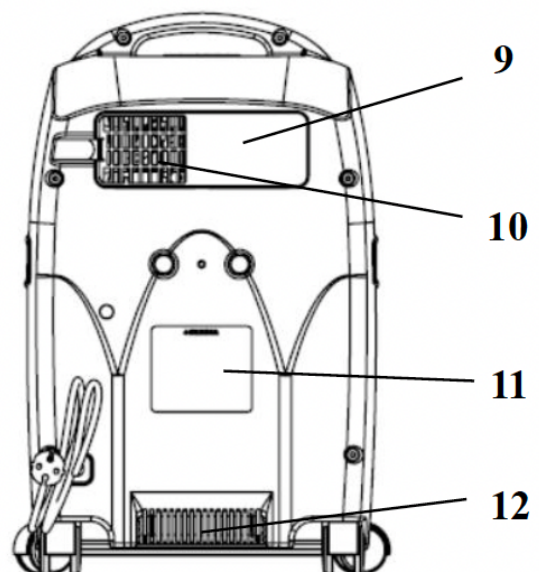

SETTING UP YOUR OXYGEN CONCENTRATOR

Position your unit near an electrical outlet convenient for the user.



WARNING: Keep the oxygen concentrator at least 5 feet away from heat source, sparks or any sources of flame.

NOTE: Do not connect to an electrical outlet controlled by a wall switch. **NO other appliances should be plugged into the same wall outlet.**

1. Position your unit at least 6 inches away from walls, draperies, or any other objects that might prevent the proper flow of air in and out of your oxygen concentrator. The oxygen concentrator should be located in an area away from pollutants or fumes.



Device operation above or outside of the voltage, temperature, humidity and/or altitude values specified may decrease oxygen concentration levels.

BEFORE OPERATING YOUR OXYGEN CONCENTRATOR

1. Before operating your unit always check to be sure the air filter (located on the back of your unit) is clean. Proper cleaning of this filter is discussed on page 14.
2. Attach the appropriate oxygen accessories to the oxygen outlet.

Oxygen Tubing Connection:

- a. Connect the oxygen outlet connector onto the oxygen outlet.
- b. Attach the oxygen tubing directly to the connector. (Figure 5)



Figure 5

Oxygen Tubing Connection with Humidifier. NOTE: Only connect the humidifier if prescribed.

1. Fill the humidifier bottle with distilled water. Do not overfill.
 2. Thread the wing nut located on the top of the humidifier bottle to the oxygen outlet so that it is suspended (Figure 6). Make sure it is securely tightened.
 3. Attach the oxygen tubing directly to the humidifier bottle outlet fitting. (Figure 7)
- Your provider has prescribed either a nasal cannula, catheter, or face mask, in most cases, they are already attached to the oxygen tubing. If not, follow the manufacturer's instructions for attachment.



Figure 6



Figure 7

4. Remove the power cord completely from the line cord strap, make sure the power switch is in Off position, and insert the plug into the wall outlet. The unit is double insulated to guard against electric shock.

NOTE: If the humidifier and tubing are assembled correctly, and the flow setting is more than 1L/min, you will feel the oxygen flow through the cannula and bubbles will rise to the water surface.

OPERATING YOUR CONCENTRATOR

Special precautions need to be taken with Oxygen Concentrators and should be used according to the EMC information provided in this manual.



Oxygen can cause rapid burning when exposed to flames. Do not smoke while your oxygen concentrator is running, or when you are near a person utilizing oxygen therapy. Keep the oxygen concentrator at least 5 feet away from hot objects, sparks, or any sources of fire.

Improper use of the power cord and plugs can cause burns, fire, or other electric shock hazards, do not use the unit if the power cord is damaged.

1. Press the power switch to “On” position. When unit is on, the Green Power light will illuminate, and the patient alert system –service Required light and audible signal —will briefly beep.

NOTE: If the Service Required light illuminates and the unit beeps but the unit is not operating, there is no power to the unit. Refer to the Minor Troubleshooting chart on page 17 and contact your provider if necessary.

If an audible low-frequency vibration sound is detected, the unit is not operating properly. Refer to the Minor Troubleshooting chart on page 17 and contact your provider if necessary.

2. Check the flow meter to make sure that the ball is centered on the line next to the prescribed number of your flow rate.



CAUTION: It is very important to follow your oxygen prescription. Do not increase or decrease the flow of oxygen without consulting your provider.

NOTE: If the flow meter knob is turned clockwise, the flow decreases (and eventually will shut off the oxygen flow). If the knob is turned counterclockwise, the flow increases.

CARING AND PERIODIC MAINTENANCE FOR YOUR UNIT



Before attempting any cleaning procedures, turn the unit Off.

Oxygen Humidifier (reusable bottles)

If your provider has prescribed humidification, clean your humidifier bottle daily. Follow the instructions supplied by the manufacturer. **If no cleaning instructions were supplied, follow these steps:**

1. Wash the humidifier in a solution of hot water and mild dishwashing detergent.
2. Soak the humidifier in a solution of one-part white vinegar to three parts hot water for 30 minutes.

This solution acts as a germicidal agent.

3. Rinse thoroughly with warm tap water and refill with distilled water for use. Do not overfill.

Cannula

Connect the cannula to the humidifier or oxygen outlet and position the nasal cannula on your face, as shown below, and breathe normally through your nose.



Figure 8

Replace the cannula and oxygen supply tubing regularly, as recommended by your provider. Clean and replace the cannula as instructed by your provider.

NOTE: Ensure the cannula is fully inserted and secure. This ensures that the Oxygen Concentrator can properly detect inspiration for oxygen delivery. During inhalation, you should hear or feel oxygen flow to the prongs of the nasal cannula.

Air Filter and Oxygen Outlet Connector

The air filter and connector should be cleaned at least once a week. To clean, follow these steps:

1. Remove the air filter (located on the back of the unit). Remove the oxygen outlet connector (if used).
2. Wash in a solution of warm water and mild dishwashing detergent.
3. Rinse thoroughly with warm tap water and towel dry. The filter should be completely dry before reinstalling.



WARNING: Do not lubricate fittings, connections, tubing, or other accessories of the oxygen concentrator to avoid the risk of fire and burns.

WARNING: Use only spare parts recommended by the manufacturer to ensure proper function and to avoid the risk of fire and burns.

WARNING: To prevent product damage, do not attempt to operate the unit without the air filter or while the filter is still damp.

WARNING: To avoid electric shock, do not remove the concentrator cabinet. The cabinet should only be removed by a qualified medical technician. Do not apply liquid directly to the cabinet or utilize any petroleum-based solvents or cleaning agents.

Clean the concentrator exterior cabinet by using a damp cloth or sponge with a mild household cleaner and wipe it dry. No need to sterilize.

Periodic Maintenance for your unit

1. Clean the gross particle filter/foam (LM5BA-ITF) once a week or as needed. Replace if damaged or torn. Listed below are the steps of cleaning the air filter.
 - a) Pull out the air filter (LM5BA-ITF) and clean the cabinet filter (LM5BA-VD) with a vacuum or cleaner or wash in a warm soapy water and rinse thoroughly.
 - b) Dry the filter thoroughly before reinstallation.



Figure 9

WARNING: Do not operate the Oxygen Concentrator without the air intake filter in place. If a second filter is available, insert the replacement filter before you clean the dirty filter. Clean the dirty filter in a warm soap and water solution then dry completely prior to use.

2. Change the air inlet filter/HEPA (LM5BA-ILF) if torn, damaged, as needed, or every three years. Follow these steps:
 - a) Open the safeguard/door (LM5BA-VD).
 - b) Pull out the old filter from the Inlet Pre-Filter.
 - c) Then insert the new filter to the Inlet Pre-Filter.
 - d) Insert the Inlet Pre-Filter and close the safeguard.

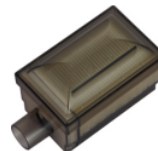

3. Change the bacteria filter (LM5BA-BF) at the time of servicing the compressor. You cannot change this by yourself.

WARNING:

You must contact your provider to change this for you.



Do not operate the Oxygen Concentrator without the air intake filter in place. If a second filter is provided, insert the replacement filter before you clean the dirty filter. Clean the dirty filter in a warm soap and water solution then dry thoroughly prior to use.

ACCESSORIES

The accessories below are tested by Rhythm Healthcare with Oxygen Concentrators:

Accessory	Item #
Cannula	LM5BA-CAN
Humidifier	LM5BA-HUMI
Humidifier Adapter	LM5BA-HUMIADP

There are many different types of humidifiers, oxygen tubing, cannulas and masks that can be used with this device. Please contact your provider for recommendations on which of these devices will be best for you. They can also guide you on proper usage, maintenance, and cleaning.



NOTE

NOTE: The use of certain humidifiers and accessories (not specified above) may impair the oxygen concentrator's performance.

NOTE: If the unit is not operating and the Service required light is on and the alarm beeps there is no power to the unit. Refer to the Minor Troubleshooting chart on page 17 and contact your provider.

NOTE: All waste from Rhythm LM5BA Oxygen Concentrator must be disposed of using the appropriate methods specified by local authorities.

NOTE: To preserve the environment, the concentrator must be disposed of using the appropriate methods specified by local authorities.

ALERT INDICATION SYSTEM

- 1 The alerts of this machine include visual indication signal (yellow, red) and auditory alert. There are three alert conditions by priority: high priority, medium priority, and low priority.
- 2 Visual alerts. If there is an audible alert, the indication light will be illuminated.

Alert Priority	Indication Light Color	Twinkle Frequency	Duty Cycle
High priority	Red	1.4Hz-2.8Hz	20%-60%
Medium priority	Yellow	0.4Hz-0.8Hz	20%-60%
Low priority	Yellow	Stays solid	100% on

3 Auditory Alerts

If there are any alerts, the device will alert at a sound level between 40dBA - 85dBA.

Alerts Priority:

1. High Priority - 5 beeps, pause for five seconds, then alarm beeps again.
2. Medium Priority - 3 beeps, pause for ten seconds, then alarm beeps again.
3. Low Priority - 1 beep, then pause for 20 seconds, then alarm beeps again.

If there are more than two beep conditions at the same time, the visual and auditory alert will display the most urgent alert.

ALERTS

Alert priority	Light color	Auditory signal	Alert meanings
High priority	Red	5 Beeps 5 second interval	After running three minutes, the oxygen concentration is less than 70%
High priority	Red	3 Beeps 5 second interval	Machines shuts down
Medium priority	Yellow	3 Beeps 10 second interval	After running three minutes the oxygen concentration is between 70% and 82%
Low priority	Yellow	1 Beep 20 second interval	The pressure is more than 20 psi or less than 3 psi

4 Actions after alert

If the oxygen purity falls below the acceptable level, the green Normal Oxygen light will shut off and the yellow Low Oxygen light will illuminate. Switch to your reserve oxygen system. Refer to the Troubleshooting section in this guide on page 17 and contact your provider.

As an added safety feature should the oxygen purity continue to drop, an intermittent audible alert will sound, and the power will be cut off. Contact your provider immediately. Do not attempt any other maintenance.

- Power-off alarm will reset automatically in less than 30 seconds.



WARNING: Do not change the alert indication preset and do not change the memory of the MCU preset.

Geriatric, pediatric or any other patient unable to communicate discomfort can require additional monitoring and/or a distributed alarm system to convey the information about the discomfort and or the medical urgency to the responsible care giver to avoid harm.

















MINOR TROUBLESHOOTING



Symptom	Possible Cause	Remedy
A. Unit does not operate. Power light is off when the power switch is "On ." Audible alert is pulsing and Service Required light is flashing.	1. Power cord not properly inserted into wall outlet.	Check power connection at the wall outlet. On 115 volt/220volt units, check the back of the unit.
	2. No power at wall outlet.	Check your home circuit breaker and reset if necessary. Use a different wall outlet if the situation occurs again.
	3. Oxygen concentrator circuit breaker activated (selected units).	Press the concentrator circuit breaker button (if equipped) located below the power switch. Use a different wall outlet if the situation occurs again.
B. Unit operates; the Power light is on when the Power switch is "On". Red Service Required light is illuminated. Audible beep may be sounding.	1. Air filter is blocked.	Check the air filter. If the filter is dirty, wash it following the cleaning instructions on page 14.
	2. Exhaust is blocked.	Check the exhaust area; make sure there is nothing restricting the unit exhaust.
	3. Blocked or defective cannula, catheter, face mask or oxygen tubing.	Detach cannula, catheter, or face mask. If proper flow is restored, clean or replace if necessary. Disconnect the oxygen tubing at the oxygen outlet. If proper flow is restored, check oxygen tubing for obstructions or kinks. Replace if necessary.
	4. Blocked or defective humidifier bottle.	Detach the humidifier from the oxygen outlet. If proper flow is obtained, clean or replace humidifier.
	5. Flow meter set too low.	Set flow meter to prescribed flow rate. If the above remedies do not work, contact your provider
C. Unit operates the power light is on when power switch is "On ", audible low-frequency vibration sound is detected.		Turn unit "off", Switch to your reserve oxygen system, and contact your provider immediately.
D. If any other problems occur with your oxygen concentrator.		Turn unit Off. Switch to your reserve oxygen system and contact your provider immediately.
F. Red Service Required light is on and an intermittent audible signal is sounding.	1. Flow meter is not properly set yet.	Ensure the flow meter is properly set to the prescribed.
	2. Air filter is blocked.	Check the air filter. If the filter is dirty, wash it following the cleaning instructions on page 14.
	3. Exhaust is blocked.	Check the exhaust area: make sure there is nothing restricting the unit exhaust. If the above remedies do not work, contact your provider.

SPECIFICATIONS:

No.	Item	Rating
1.	Delivery Rate	1 - 5 L/min
2.	Outlet Pressure	8.5 PSI (58.6KPa)
3.	Electrical Rating	115VAC, 60Hz<365VA 230VAC,50Hz<365VA
4.	Oxygen Percentage	1~5 L/min 93%±2%
5.	Sound level	47~49dB
6.	Operating Environment Range	Temperature 50°F - 104°F Humidity: 30% to 70% Atmospheric pressure 50-106 kpa (7.3-15.4 psi)
7.	Operating Altitude (Tested at 69.8°F only) 0-2000 M (0-6561 ft) 2000-4000 M (6561-13123 ft)	Across the voltage range: No degradation of performance Not recommended/efficiency less than 85%
8.	The visible" low oxygen "indicator will activate at the following level	Less than 82% will activate at the following level (the red "service required" light will activate)
9.	Pressure Relief Valve	40 psig ± 5psig (276 kPa±34.5 kPa)
10	Product Weight	35.25 lbs
11	Dimensions	23" H x 14.2" W x 11.4" D
12	Operating System	Time Cycle / Pressure Swing
13	Storage Conditions	Temperature -40°F - 158°F Humidity 10% - 100% Atmospheric pressure 50~106 kpa (7.3~15.4 psi)
14	Equipment Class and Type	The type of protect against electric shock: Class II The degree of protect against electric shock: TYPE B Applied part

SYMBOLS

	Warning - Describes a hazard or unsafe practice that can result in severe bodily injury, death, or property damage
	Caution – Describes a hazard or unsafe practice that can result in minor bodily injury or property damage
	Note – Provides information important enough to emphasize or repeat
	Consult the accompanying documents
	Type BF Equipment
	Class II Equipment, double insulated
	Do not use oil or grease
	Do not expose to open flames, sparks or heat sources
	Do not smoke near unit
	Do not disassemble
	Consult instructions
	See manual
SN	Manufacturer's serial number
	Date of manufacture
	Manufacturer
	Proper disposal of waste of electrical and electronic equipment required
	FRAGILE Contents of the transport package are fragile therefore it shall be handled with care.

	THIS WAY UP Indicates correct upright position of the transport package.
IPX1	Drip proof equipment
	Keep away from rain and water. Transport package shall be kept away from rain.
	Non-ionizing electromagnetic radiation

ELECTROMAGNETIC INFORMATION

Guidance and manufacturer's declaration – electromagnetic emissions		
The LM5BA is intended for use in the electromagnetic environment specified below. The customer or the user of the LM5BA should assure that it is used in such an environment.		
Emissions test	Compliance	Electromagnetic environment-guidance
RF Emissions CISPR 11	Group 1	The device uses RF energy only for its internal function. Therefore, its RF emissions are very low and are not likely to cause any interference in nearby electronic equipment.
RF Emissions CISPR 11	Class B	The device is suitable for use in all establishments, including domestic establishments and those directly connected to the public low-voltage power supply network that supplies buildings used for domestic purposes.
Harmonic Emissions IEC 61000-3-2	Class A	
Voltage Fluctuations/Flicker Emissions IEC 61000-3-3	Complies	

Guidance and manufacturer's declaration – electromagnetic immunity

The LM5BA is intended for use in the electromagnetic environment specified below. The customer or the user of the LM5BA should assure that it is used in such an environment.

Immunity test	IEC 60601 test level	Compliance level	Electromagnetic environment-guidance
Conducted RF IEC 61000-4-6	3 Vrms 150 kHz to 80 MHz	3 V	<p>Portable and mobile RF communications equipment should be used no closer to any part of the LM5BA OXYGEN CONCENTRATOR including cables, than the recommended separation distance calculated from the equation applicable to the frequency of the transmitter.</p> <p>Recommended separation distance</p> $d = \left[\frac{3.5}{V_1} \right] \sqrt{P}$ $d = \left[\frac{3.5}{E_1} \right] \sqrt{P} \quad 80 \text{ MHz to } 800 \text{ MHz}$ $d = \left[\frac{7}{E_1} \right] \sqrt{P} \quad 800 \text{ MHz to } 2.5 \text{ GHz}$ <p>Where P is the maximum output power rating of the transmitter in watts (W) according to the transmitter manufacturer and d is the recommended separation distance in meters (m).^b</p>
Conducted RF IEC 61000-4-3	3 V/m 80 MHz to 2.5 GHz	3 V/m	<p>Field strengths from fixed RF transmitters, as determined by an electromagnetic site survey,^a should be less than the compliance level in each frequency range.^b</p> <p>Interference may occur in the vicinity of equipment marked with the following symbol:</p> 

NOTE 1 At 80 MHz and 800 MHz, the higher frequency range applies.

NOTE 2 These guidelines may not apply in all situations. Electromagnetic is affected by absorption and reflection from structures, objects, and people.

^a Field strength from fixed transmitters, such as base stations for radio (cellular/cordless) telephones and land mobile radios, amateur radio, AM and FM radio broadcast and TV broadcast cannot be predicted theoretically with accuracy. To assess the electromagnetic environment due to fixed RF transmitters, an electromagnetic site survey should be considered. If the measured field strength in the location in which the LM5BA is used exceeds the applicable RF compliance level above, the LM5BA should be observed to verify normal operation. If abnormal performance is observed, additional measures may be necessary, such as reorienting or relocating the LM5BA.

^b Over the frequency range 150 kHz to 80 MHz, field strengths should be less than 3 V/m.

LIMITED WARRANTY

Rhythm Healthcare, LLC warrants the LM5BA Oxygen Concentrator under the conditions and limitations stated below. Rhythm Healthcare, LLC warrants this equipment to be free from defects in workmanship and materials for three (3) years from date of factory shipment to the original purchaser, (typically the healthcare provider) unless contractually specified otherwise. This warranty is limited to the Buyer of new equipment purchased directly from Rhythm Healthcare, LLC, or one of its Providers, Distributors, or Agents. Rhythm Healthcare, LLC's obligation under this warranty is limited to product repair (parts and labor) at its factory or at an Authorized Service Center. Routine maintenance items, such as filters, are not covered under this warranty, nor does it cover normal wear and tear.

Warranty Claims

The original purchaser must submit any warranty claim to Rhythm Healthcare, LLC or to an Authorized Service Center. Upon verification of the warranty status, instructions will be issued. For all returns, the original purchaser must (1) properly package the unit in a Rhythm Healthcare, LLC's approved shipping container, (2) properly identify the claim with the Return Authorization Number, and (3) send the shipment freight prepaid. Service under this warranty must be performed by Rhythm Healthcare, LLC and/or an Authorized Service Center.

NOTE: This warranty does not obligate Rhythm Healthcare, LLC's to provide a loaner unit during the time that an oxygen concentrator is undergoing repair.

NOTE: Replacement components are warranted for the unexpired portion of the original Limited Warranty. This warranty shall be voided, and Rhythm Healthcare, LLC shall be relieved of any obligation or liability if:

- The device has been misused, abused, tampered with, or used improperly during this period.
- Malfunction results from inadequate cleaning or failure to follow the instructions.
- The equipment is operated or maintained outside the parameters indicated in the operating and service instructions.
- Unqualified service personnel conduct routine maintenance or servicing.
- Unauthorized parts or components (i.e., regenerated sieve material) are used to repair or alter the equipment.
- Unapproved filters are used with the unit.