

USER MANUAL

---

# OAKWORKS® PF Series Tables



**OAKWORKS®**  
MEDICAL PRODUCTS

Printed in U.S.A.

All rights are reserved. No part of this document may be photocopied, reproduced or translated to another language without prior written consent of OAKWORKS®, Inc.

OAKWORKS® is a registered trademark of OAKWORKS®, Inc.

#### Notice

The information contained within this document is subject to change without notice and should not be construed as a commitment by OAKWORKS®, Inc.

OAKWORKS®, Inc. encourages requests for technical specifications and the like documentation to ensure accuracy. The appropriate documentation is available upon request.

OAKWORKS®, Inc. shall not be liable for incidental or consequential damages in connection with or arising out of the furnishing, performance, or use of this document and the program material which it describes.

# TABLE OF CONTENTS

---

- Product Use Description ..... 1
- Important Safety Instructions
  - Symbol Identification ..... 1
  - Safety Instructions..... 2-3
- Installation
  - Grounding ..... 4
- Product Description & Photo
  - PF400 ..... 5
  - Control Operations - PF400..... 6
  - PF250 ..... 7
  - Control Operation - PF250 ..... 8
- Directions for Use
  - Moving the Table..... 9
  - Leveling the Table..... 9
  - Lift-Assist Backrest Adjustment ..... 10
  - Locking Casters Use (Option)..... 10
  - Removing the Top Pad..... 11
  - Integrated Heated Top (Option)..... 12
  - QuickLock Face Rest (Accessory Option)..... 13
  - Adjustable Side Arm Rest (Accessory Option - PF400 Only) ..... 14
- Cleaning & Disinfection
  - Recommended Cleaners/Disinfectants ..... 15
  - Cleaning Process ..... 15
  - Inspections & Maintenance..... 16
- Warranty Information ..... 16
- Model Number & Serial Number ..... 17
- Specifications
  - Table Dimensions - PF400 ..... 18
  - Table Dimensions - PF250 ..... 18
  - Product Specifications ..... 19
  - Environmental Conditions..... 19
  - Electrical Specifications..... 19
  - Guidance and manufacturer’s declaration -
    - Electromagnetic emissions ..... 20
    - Recommended separation distances ..... 20
  - Guidance and manufacturer’s declaration -
    - Electromagnetic immunity..... 21-22
- Contact Information ..... back cover

---

## PRODUCT USE DESCRIPTION

The PF Exam Table is a powered positioning table used for routine treatment and examination procedures. It is intended to be operated by a healthcare professional in a medical environment. No special training is required but a review of the following User Manual is important for the safety of the operator and patient. The healthcare professional should read and understand this entire manual before use with a patient. There are no known contraindications with the use of this equipment.

## SYMBOL IDENTIFICATION



This symbol, when used in this manual and on product labels, represents a caution warning. Be sure to read and comply with all precautions and warnings.



This symbol, when used in this manual and on product labels, warns against an electrical shock hazard. Be sure to observe and comply with all warnings.



This symbol, when used in this manual or on product labels, indicates a Protective Earth (Ground) Terminal.



This symbol, when used in this manual or on product labels, indicates that the product should be protected from moisture. The humidity specifications for Transport & Storage are listed in the environmental conditions section of this manual.



This symbol is used to indicate that the operator should consult the user manual.



This symbol, when used in this manual and on product labels, indicates that the table and components are a Type B Applied Part pursuant to IEC 60601-1.



This symbol, when used in this manual or on product labels, indicates alternating current (AC).



This symbol, when used in this manual or on product labels, indicates direct current (DC).

# IMPORTANT SAFETY INSTRUCTIONS

---

## IMPORTANT SAFETY INSTRUCTIONS



### DANGER

READ AND SAVE THESE INSTRUCTIONS

To reduce risk of electric shock:

1. Always unplug this furnishing from the electrical outlet before cleaning.
2. Connect this furnishing to a properly grounded outlet only. See Grounding Instructions in this manual.

Electrical Shock Hazard - The power supply/control module is located on the lift frame. No user serviceable parts are inside. Refer servicing to qualified personnel. Unplug wall plug prior to contact with any cables connected to the power supply.



### WARNING

To reduce the risk of burns, fire, electric shock or injury to persons:

1. Unplug from outlet before adding or removing parts.
2. Never operate this furnishing if it has a damaged cord or plug, if it is not working properly, if it has been dropped or damaged, or dropped into water. Contact Oakworks Customer Service before use at 717.235.6807.
3. Keep the cord away from heated surfaces.
4. Never drop or insert any object into any opening.
5. Do not use outdoors.
6. Use this furnishing only for its intended use as described in these instructions. Do not use attachments not recommended by the manufacturer.
7. To disconnect, turn all controls to the off position, then remove plug from outlet.
8. Improper connection of the equipment-grounding conductor can result in a risk of electric shock. Check with a qualified electrician if you are in doubt as to whether the product is properly grounded.
9. Do not modify the plug provided with the product - If it will not fit the outlet, have a proper outlet installed by a qualified electrician.



### WARNING

- Risk of Injury - 550 lbs. (250 kg.) maximum load.
- Risk of Injury - Do not operate this equipment unless properly trained.
- Close supervision is necessary when this furnishing is used by, or near children, invalids, or disabled persons.
- This unit is For Commercial Use Only and to be operated only by trained personnel..
- Lifting & Top motion electric motors are rated at 10% duty cycle max. (2 minutes on, 18 minutes off)



### PINCH HAZARD

- Keep hands, feet and controls away from the table while making adjustments.
- Risk of Injury - Not to be used in locations where children or people with cognitive disabilities are anticipated to be present.
- Risk of Injury - Children should NEVER be near the table when in use.

---

## ENTRAPMENT

- Risk of Injury - The picture below indicate areas of entrapment that can occur when operating this equipment. It is the responsibility of the operator to ensure that bystanders are not in or around these areas during operation.

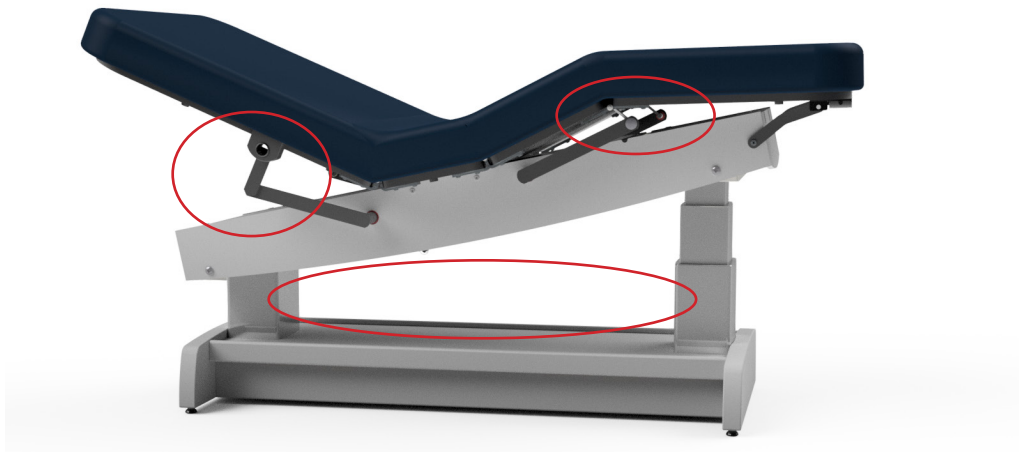

## CAUTION

- The use of accessories, transducers, and cables other than those specified by the manufacturer, may result in increased emissions or decreased immunity of the table.
- The table should not be used adjacent to or stacked with other equipment. If adjacent or stacked use is necessary, the table should be observed to verify normal operation in the configuration in which it will be used.
- The table is designed to be a stand-alone table. This table must not be modified or incorporated into any other equipment.
- Proper operation of this equipment is very important for the safety of the operator, client, and any other individuals in the area of this equipment. Directions for use of this equipment are described in this manual. The operator should read these sections carefully.
- Weight Limit: (patient and accessories) 550 lbs. (250 kg.) Do not exceed.
- Be certain that the table is completely lowered without any tilt being present prior to discharging an ambulatory client. The client may lose balance and fall.
- When lowering the table, make sure there is nothing underneath the tabletop that can impede motion (like stools, cabinets, accessory parts, cleaners, etc.) When using the table Height Up function, do not place anything between the metal frame and the base structure. Damage can occur to the table.
- Do not sit on backrest or footrest sections.
- Before moving any of the tables, disconnect the power cord from the power outlet.
- The table weighs as much as 235 lbs. (107 kg.)
- Do not lift table by the tabletop pad. This can damage the removable pad. Use extreme caution when lifting the table to move it. 4 people are required to move the table safely.
- Do not use the table to transport a patient.

# INSTALLATION

All tables come completely assembled and ready to use. Plug the cord into a functioning outlet that is rated for the table. (See Grounding below)

Arrange the power cord and control cords so that they will not create a tripping hazard and where the controls are located to your liking and are conveniently accessible.

Be sure access to plug is not blocked for disconnecting the table from power.

## GROUNDING



### DANGER

Risk of Electric Shock - Connect this furnishing to a properly grounded outlet only.

This product must be grounded. If it should malfunction or break down, grounding provides a path of least resistance for electrical current to reduce the risk of electric shock. This product is equipped with a cord having an equipment-grounding conductor and a grounding pin. The pin must be plugged into an appropriate outlet that is properly installed and grounded in accordance with all local codes and ordinances. See U.S. sample below.

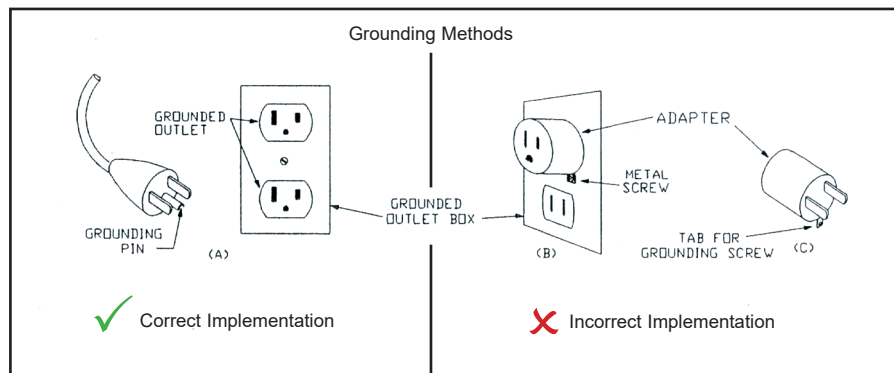

Improper connection of the equipment-grounding conductor can result in a risk of electric shock. Check with a qualified electrician or service person if you are in doubt as to whether the product is properly grounded. Do not modify the plug provided with the product - if it will not fit the outlet; have a proper outlet installed by a qualified electrician.

## PRODUCT DESCRIPTION

---

### PF400



STANDARD SPECIFICATIONS	
Motion 1 w/ 4" Foam	Powered 22"-37.5" (56-95 cm.) Height Range
Motion 2	Powered $\pm 15^\circ$ Trendelenburg/ Reverse Trendelenburg
Motion 3	Powered 0-55 $^\circ$ Backrest
Motion 4	Powered 0-50 $^\circ$ Foot Rest
Foot Control	All powered motions
Table Voltage Options	120V/60Hz - 230V/50Hz Switch Mode Power Supply
Table Capacity	550 lbs. (250 kg.) (Patient and accessories)
Widths	29" (74 cm.), 31" (79 cm.) or 33" (84 cm.)
Length	73" (185 cm.)
Padding	3" (8 cm.) or 4" (10 cm.) Comfort Foam™
Table Weight*	235 lbs. (107 kg.)

OPTIONS
Wood Finishes
Locking Casters
Integrated Heated Top
ACCESSORIES
QuickLock Face Rest
Table Extender - 12" (30.5 cm.) Long
Side Arm Rest

For electrical specs, see Specifications section.



# PRODUCT DESCRIPTION

## CONTROL OPERATIONS - PF400

**CAUTION** Do not sit on backrest or footrest sections. The hood area under the backrest top is not designed for storage. DO NOT use this area for holding anything. Damage can occur to the table.

The PF400 Tables offer trendelenburg, height, backrest and footrest positioning with electronic ease. Operate the foot and/or optional hand control as shown below to raise or lower the trendelenburg, height, backrest or footrest functions of the table.

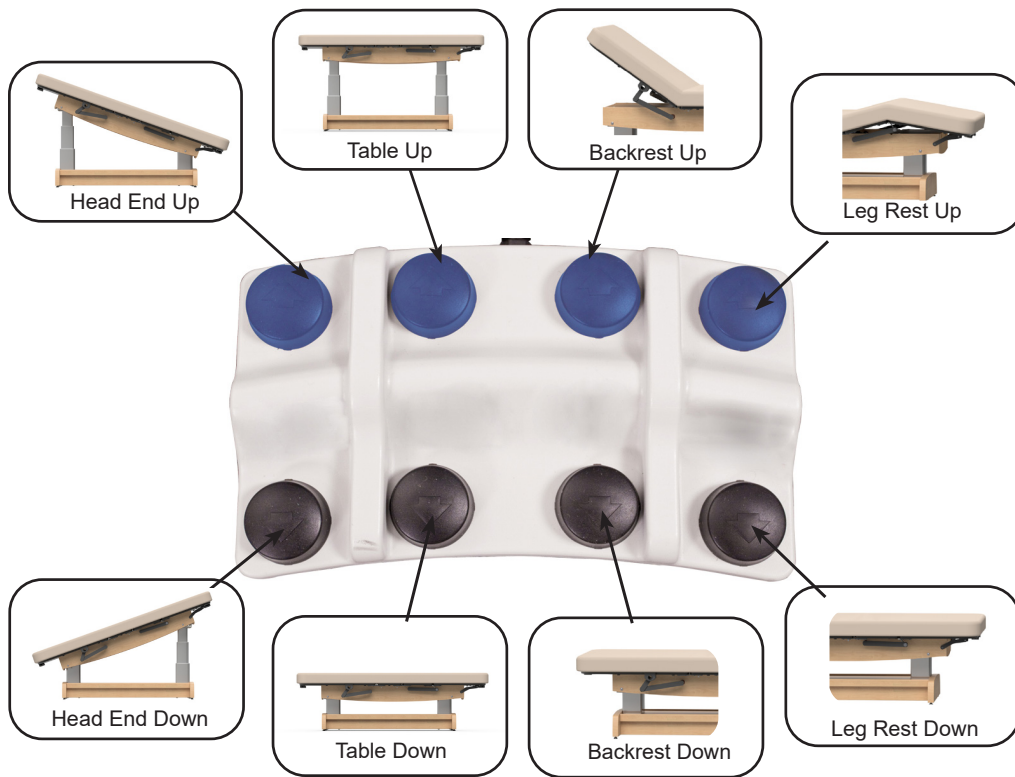

### OPTIONAL HAND CONTROL

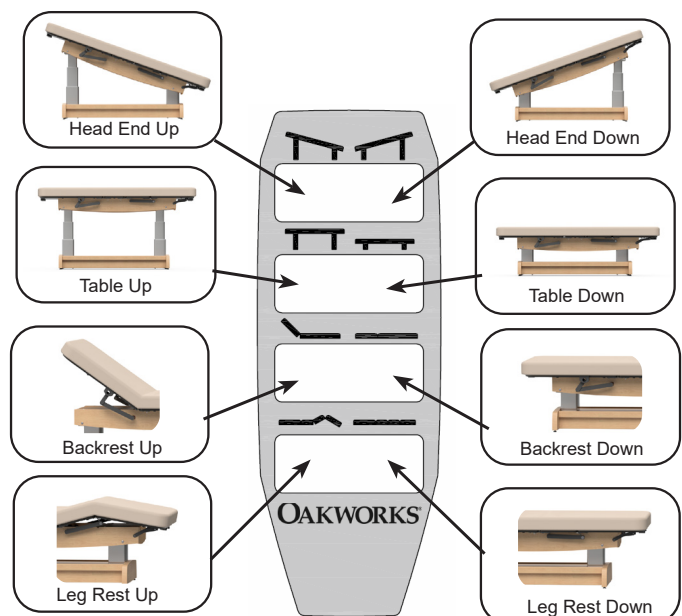

## PRODUCT DESCRIPTION

---

### PF250



STANDARD SPECIFICATIONS		OPTIONS
Motion 1 w/ 3" Foam	Powered 22"-37.5" (56-95 cm.) Height Range	Wood Finishes
Motion 2	Powered $\pm 15^\circ$ Trendelenburg/ Reverse Trendelenburg	Locking Casters
Motion 3	Manual 0-80° Backrest	Integrated Heated Top
Foot Control	All powered motions	ACCESSORIES
Table Voltage Options	120V/60Hz - 230V/50Hz Switch Mode Power Supply	QuickLock Face Rest
Table Capacity	550 lbs. (250 kg.) (Patient and accessories)	Table Extender - 12" (30.5 cm.) Long
Widths	29" (74 cm.), 31" (79 cm.) or 33" (84 cm.)	
Length	73" (185 cm.)	
Padding	3" (8 cm.) or 4" (10 cm.) Comfort Foam™	
Table Weight*	210 lbs. (95 kg.)	

For electrical specs, see Specifications section.

# PRODUCT DESCRIPTION

## CONTROL OPERATIONS - PF250

**CAUTION** For Lift-Assist Backrest Tables; Do not sit on backrest section. The hood area under the backrest top is not designed for storage. DO NOT use this area for holding anything. Damage can occur to the table.

The PF250 tables offer trendelenburg and height positioning with electronic ease. Operate the foot control and/or optional hand control as shown below to raise or lower the trendelenburg and height functions of the table.

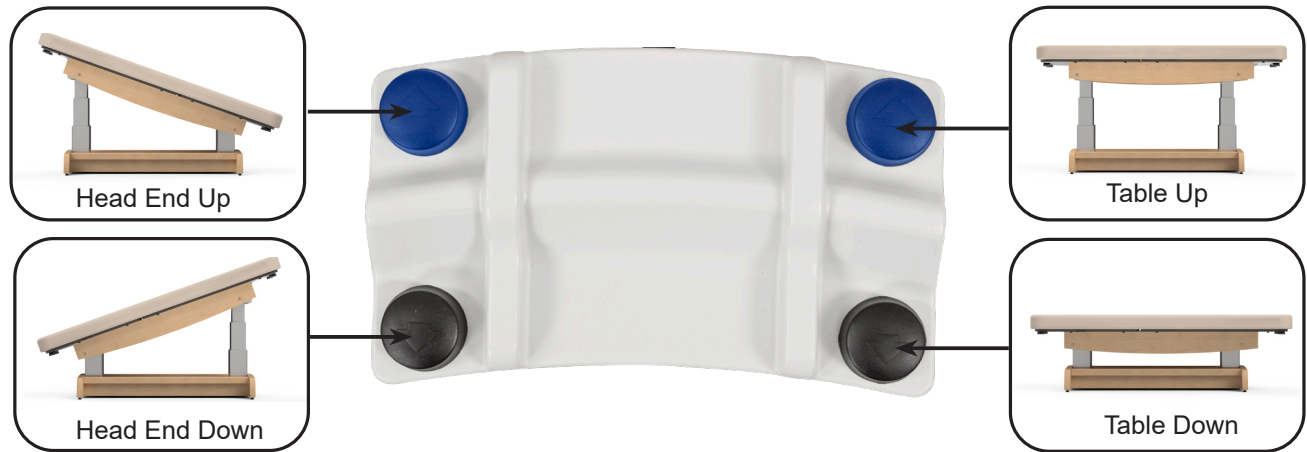

### OPTIONAL HAND CONTROL

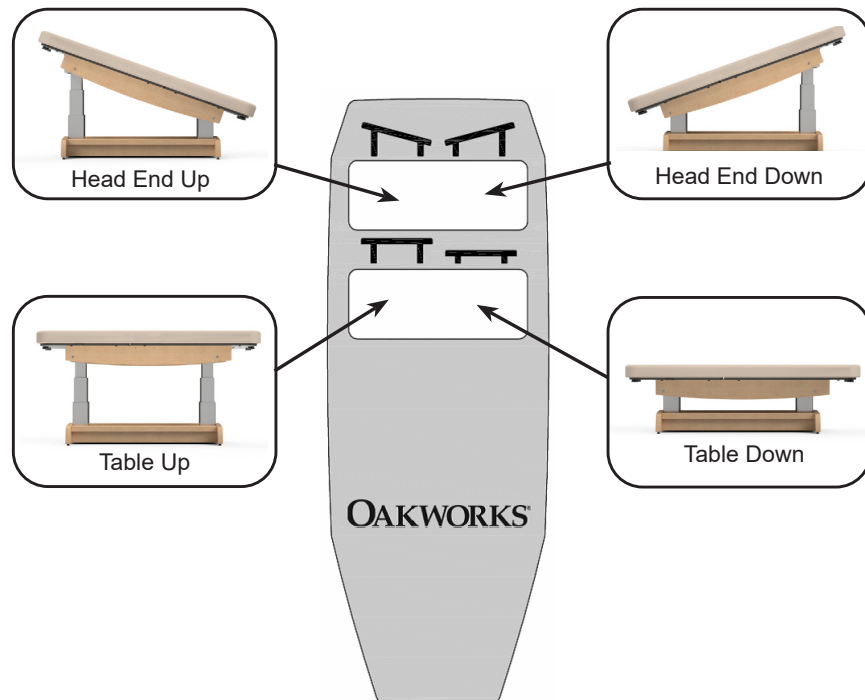

## DIRECTIONS FOR USE

### MOVING THE TABLE



#### CAUTION

Before moving the table, disconnect the power cord from the power outlet. The table weighs as much as 235 lbs. (107 kg.) Never lift the table by grasping the table top. You could damage the table and the electronics that run the tabletop. Four people are required to move the table safely. Do not use the table to transport a patient.

When moving the table, place one person at each corner of the table. Have each person firmly grasp the base at the bottom and lift the table. Be aware and use proper, safe procedures for moving a table of this size to prevent injury to yourself or the table. We strongly recommend that a flatbed dolly be used that can hold the entire table when moving the table long distances.

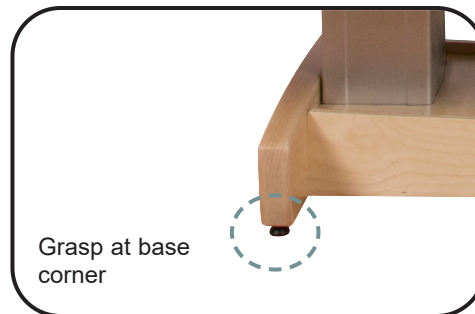

### LEVELING THE TABLE

Place the table in the location where you plan to use it.

1. Rock the table to determine if it is level with the floor. If the table rocks back and forth at all, the foot that clears the floor when you rock the table will need adjustment.
2. Adjust the Leveler Foot by first loosening the locking nut found just above the rubber Leveler Foot with the open-end wrench.
3. Lower the adjustable rubber Leveler Foot until it meets the floor snugly. Tighten the locking nut against the wooden leg of the table with the open-end wrench to fix the Leveler Foot in position.
4. Rock the table again to be sure adjustments have stabilized the table. If necessary make any additional adjustments in the same way.

Leveler Foot

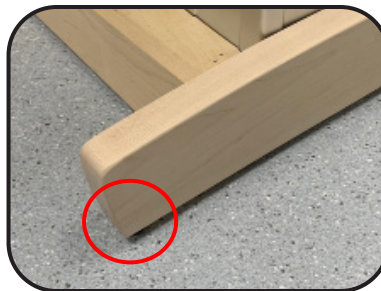

1/2" (13mm) Open end Wrench



Locking Nut



Tighten Locking Nut

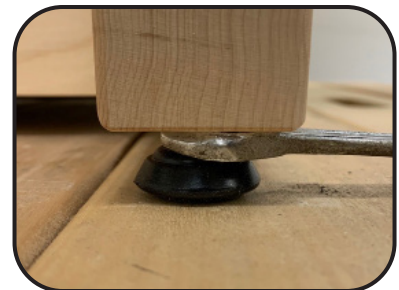

## DIRECTIONS FOR USE

---

### LIFT-ASSIST BACKREST USE (PF250)

 **CAUTION** Do not sit on the Backrest section.



#### TO RAISE THE BACKREST:

Raise the back rest by pressing the lever under the head section and lifting up to the desired height. It is recommended that patients take some of their weight off the backrest while you lift.



#### TO LOWER THE BACKREST:

Press the lever under the head section and push the back rest down.

### LOCKING CASTERS USE (OPTION)

All casters should be locked during use with a client.



#### LOCKING THE CASTERS

1. Place your foot on the end of the casters locking tab.
2. Press firmly downward until you hear a clicking noise and the caster is locked.



#### UN-LOCKING THE CASTERS

1. Place your foot on top of the casters locking tab.
2. Press firmly inward and downward until you hear a clicking noise and the caster is unlocked.



# DIRECTIONS FOR USE

## REMOVING TOP PAD

The top pad has been designed to be easily removable and replaceable with no tools needed.

### IF THE TABLE HAS A HEATED TOP:

Unplug the table from the wall outlet and disconnect the wires circled from the control box located under the platform. Pull the cables through the platform before completely removing the top pad.

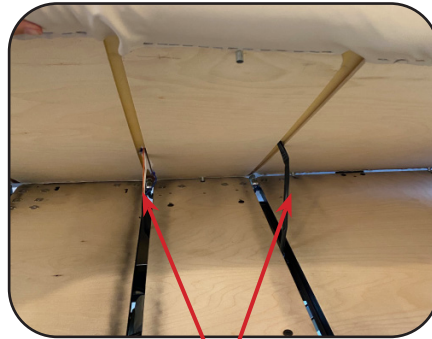
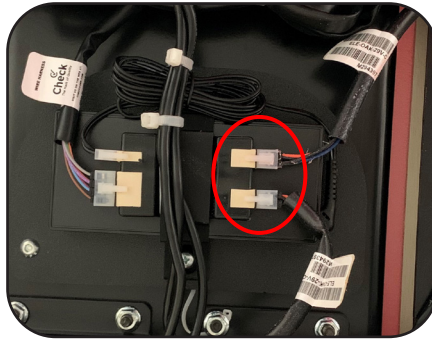

Heated Top Cables

### TO REMOVE THE TOP PAD:

The top pad is attached to the platform with 8 thumb screws located below the platform as shown.

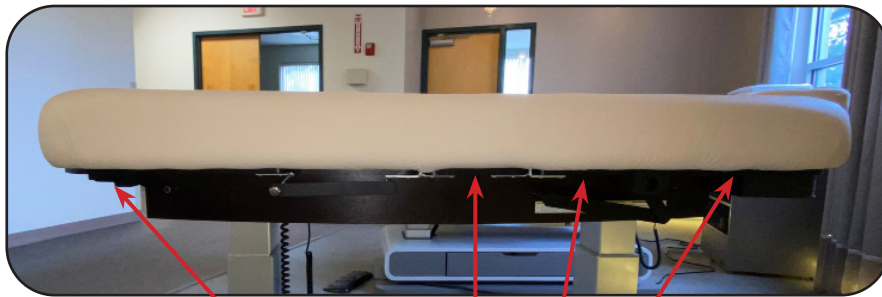

Thumb Screw Locations (4 per side)

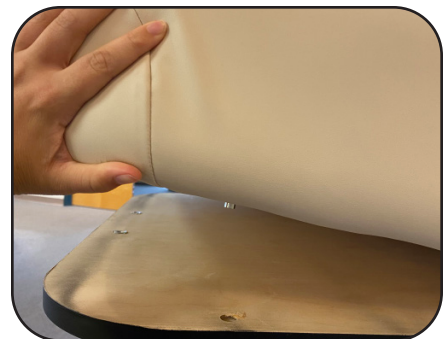

1. Unscrew the thumb screw clockwise until the thumb screw is completely removed. Repeat for all 8 thumb screws. If the thumbs screws are on too tight, a 3/16" bit can be used.

2. Lift top pad off the platform.

## DIRECTIONS FOR USE

---

### INTEGRATED HEATED TOP (OPTION)

#### USING THE INTEGRATED HEATED TOP:

The table comes with the option for a fully integrated heated top pad. Simply press the heating indicator located on the right side of the table to the desired heat level. The heat can reach up to 43°C (110°F).

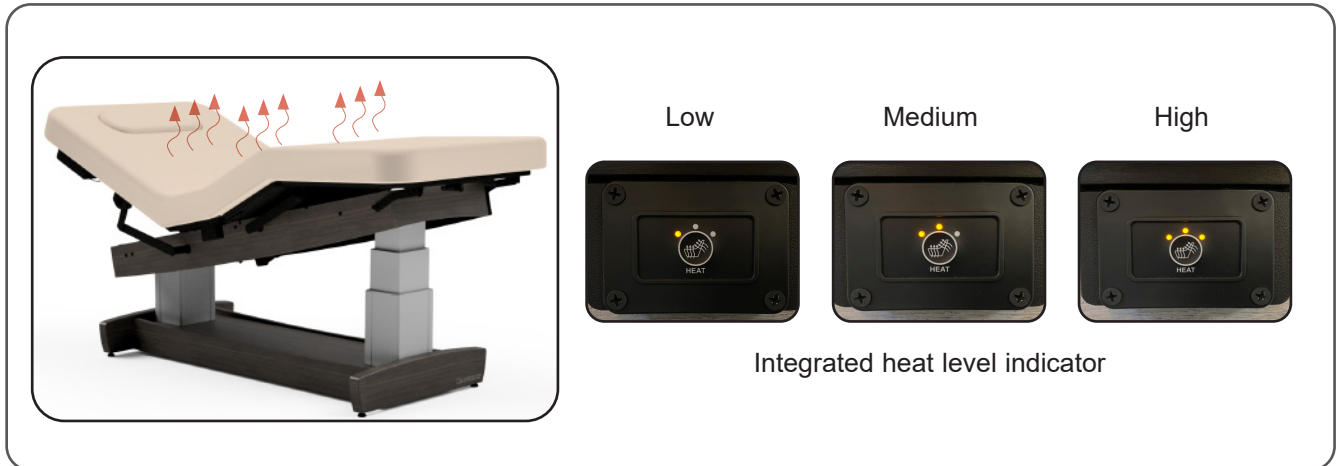

#### BLINKING LIGHTS

If the controller's heat level indicator lights are blinking, the heating elements are not connected properly and/or damaged. Unplug the table and locate the control box on the underside of the table top. Disconnect the heating element connectors from the control box and reconnect. Plug the power cord back into the wall outlet. Call Customer Service at 717.235.6807 if problem continues.

## DIRECTIONS FOR USE

### QUICKLOCK FACE REST (ACCESSORY OPTION)



#### CAUTION

- QuickLock Face Rest Weight Limit - 25 lbs (11.3 kg)
- Do not put excessive weight or pressure on the Face Rest.
- Excessive pressure can cause premature failure of the Face Rest.

Double articulating action provides nearly limitless positioning options with the QuickLock™ Face Rest. The adjustable pad takes pressure off sensitive facial areas while providing superb support. The QuickLock™ Face Rest can be used in both prone and supine positioning and folds out of the way when not in use. Adjustments are made easily by loosening the cam locks, adjusting for height and angle and then locking locks into that position. The table has a bracket at the head of the table for a variety of uses.



#### ATTACHING QUICKLOCK FACE REST:

When attaching the QuickLock™ Face Rest, slide the frame dowels into the bracket until bullet catches are snapped into place.

To remove the QuickLock™ Face Rest, gently pull the headrest by the dowels until it comes free. Set it safely aside or store it inside the under-table cabinet until needed.

To remove



Pull by dowels

Pull by dowels

#### Tips for Great Positioning using the QuickLock™ Face Rest:

To use the face rest with your clients supine, rotate the face rest pad so that the thick part of the pad supports your client's cervical region. Adjusting the height and angle of the face rest gives your clients perfectly comfortable support.

The face pad is flexible so that you can bring the open ends together or spread them apart to achieve the most comfortable support for any size face. To avoid your client's chin from hitting the spacebar, make sure the pad is narrow enough to support their whole face.

For appropriate cervical flexion, use the cam locks to adjust the downward angle of the face rest, making sure that the surface of the face rest pad at the chin is not lower than the surface of the table.

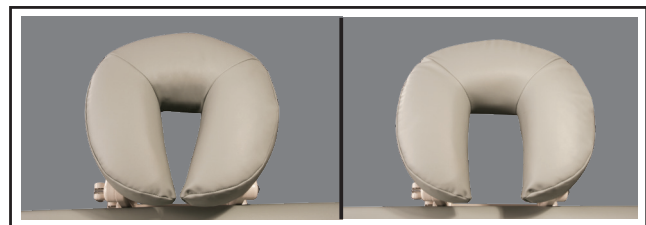



## DIRECTIONS FOR USE

---

### ADJUSTABLE SIDE ARM RESTS (ACCESSORY OPTION - PF400 ONLY)



#### CAUTION

- Do not use the arm rest for client support during the mounting or dismounting of the chair.
- The arm rest is not designed to support the client's weight.

#### TO INSTALL THE ARM RESTS:

The Arm Rests adjust automatically as the back rest moves to remain parallel to the floor.



1. Insert end of arm rest into backrest hole while holding the arm rest at a 60° angle to the backrest.
2. Push end all the way into the hole and drop the arm rest into the horizontal position. Pull outward to make sure the arm rest is secure.

#### TO LEVEL THE ARM RESTS:

The Arm Rest height is adjusted at the factory for each table. If the armrest starts to sag with repeated use, follow the steps below to readjust.

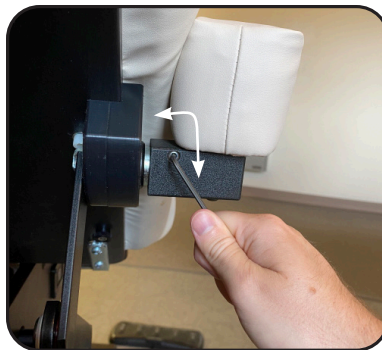
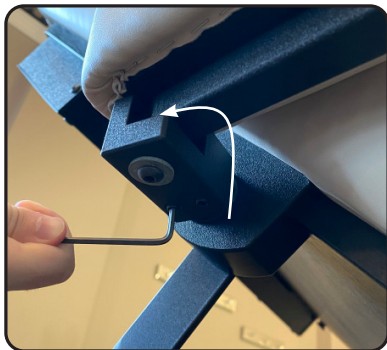

1. Loosen the bottom 2 set screws.
2. Turn the side set screw (clockwise to raise or counter-clockwise to lower) while adjusting the arm rest. Lift the arm rest slightly when doing this adjustment to reduce the weight.
3. Tighten the two bottom set screws to lock the position.

## CLEANING & DISINFECTION

### RECOMMENDED CLEANERS/DISINFECTANTS



#### DANGER

To reduce the risk of electric shock:

- Always unplug this furnishing from the electrical outlet before cleaning.

Reference the Recommended Cleaners and Disinfectant list (MMINML0008-EN) that came with the table. This information can also be found at [www.oakworksmed.com](http://www.oakworksmed.com) under product information.

All cleaners and disinfectants have the ability to degrade the upholstery to some extent. However, following the recommended cleaner and disinfectant list and cleaning process will provide the best care for your table and support a long product life.

Oakworks recommends a prepackaged wipe for cleaners/disinfectants to ensure best distribution of disinfectant for the required kill time, without leaving excess residue and/or overexposing components therefore minimizing the potential for damage to materials. Please read and follow disinfectants manufacturers' directions for cleaning and disinfection.

Oakworks does NOT recommend the use of cleaners/disinfectants containing Hydrogen Peroxide, Acetic Acid, or Phenolics. These chemicals can cause damage to the appearance and/or material integrity of various components. Also, while the recommended cleaners/disinfectants list includes products containing Quaternary Ammonium compounds ("quats"), not all products containing quats are approved for use. Some contain additional detergents and/or surfactants which can damage some materials.

A note on Bleach: While a 10% sodium hypochlorite (household bleach) solution (EPA No.: 5813-100 or equivalent) can be an effective disinfectant and is dilute enough to be benign to most materials, it alone is not an effective cleaner and a separate product must be used for the initial cleaning steps of the procedure. Because of possible chemical incompatibilities between various cleaning products and bleach, utmost care must be taken by the user to avoid potential exposure to harmful or toxic by-products of the combination. Also, because bleach leaves a potentially corrosive residue as it evaporates, it must be rinsed with clean water after disinfection.

**Use of non-approved cleaners or disinfectants may lead to damage to upholstery and other materials found on the table and will void the warranty.**

### CLEANING PROCESS

Follow the cleaners/disinfectant manufacturers' directions for use. Please note that cleaning and disinfecting an Oakworks table is a two part process. First it must be cleaned of any visible soil, then it can be disinfected. Oakworks recommends that the table be positioned in the flat position during the cleaning process. Please follow this procedure for best results:

1. Using an approved cleaner or mild liquid soap and water, clean any visible soil off of the table, working from the top to the bottom of the table. It is recommended that the upholstery be cleaned at least once a week to prevent disinfectant build up.
2. Rinse with clean water and dry with a clean cloth or towel.
3. Using an approved disinfectant, thoroughly disinfect all surfaces of the tabletop and any high-contact areas such as handles, handsets, etc., making sure they remain wet for the disinfectant manufacturer's recommended contact time. Do not allow disinfectant to pool on the upholstery after the recommended contact time.
4. Wipe off any excess liquid with a cloth or towel and clean water.
5. Dry all surfaces with a clean cloth or towel.

Avoid using writing instruments or other similar instruments around the upholstery as it can cause permanent staining. If this does occur, do not wipe with an alcohol based cleaner. Instead, blot the stain with a clean cloth/ paper towel. Use a 10% bleach dilution to remove the stain. Follow this with a rinse of clean water.

## INSPECTIONS / WARRANTY

### INSPECTIONS

#### RECOMMENDED REGULAR INSPECTIONS (monthly or local standard)

- Check for damage to the power, hand control(s) and foot control(s) on all cables.
- Visually inspect components for obvious damage that could cause problems during operation.
- If the table is creaking / squeaking when raising and lowering the table, apply a liberal amount of lithium grease to the aluminum channel and slide block indicated below.



- If the table is creaking/ squeaking during movement of the electric salon top, apply a small amount of lithium grease to the linkages and bushings indicated below. Be sure to wipe off any excess grease.



#### RECOMMENDED PERIODIC INSPECTIONS (yearly or local standard)

- Check for damage to the power, hands control and foot control cables and all visible wiring.
- Visually inspect components for obvious damage that could cause problems during operation.
- Check all mechanical functions using the hand control. Repeat using the foot control. Check for abnormal noises.
- Check that all fasteners are present and fastened securely.
- Check table grounding.
- Clean unusual buildup of dirt on the table and/or parts of the table not normally cleaned on a regular basis.
- Check for tears or cracks in the upholstery.

### WARRANTY

View complete warranty details at [www.oakworksmed.com](http://www.oakworksmed.com) under the Information tab “Warranty and Return Policy”.

# MODEL NUMBER & SERIAL NUMBER

## MODEL & SERIAL NUMBERS



The model number and serial numbers are located on the lift column at the foot end of the table.

Model Number

Serial Number

**PF Series Tables**



16796025 PFEX4EX1T410USXXX  
SER#: PEX123456  
PF400 ELECTRIC SALON 1/T/4/10/US/XX/XX  
TTBLUEGRASS 01/01/2020 ORDER#:654321  
NOTES: SAMPLE PRODUCT LABEL

120V~ 60Hz  
4.0 Amps Max

 CONFORMS TO:  
ANSI/AAMI  
STD ES80601-1  
IEC STD 60601-1-6  
Certified to  
CAN/CSA STD  
C22.2 No. 60601-1

**Intertek**  
3034177

230V~ 50/60Hz  
 1.0 Amps Max  
 2.0 Amps Max  
 2.1 Amps Max  
 3.0 Amps Max



**Class 1 Equipment**  
Duty Cycle:  
**MAX 2 minutes ON**  
**18 minutes OFF**



**OAKWORKS, Inc.**  
923 East Wellspring Rd.  
New Freedom, PA 17349 USA  
Phone: 717-235-6807  
[www.oakworks.com](http://www.oakworks.com)

made in the USA  
with US & imported parts





Part No. CN70537-13 - Rev. 1

Model and Serial numbers always start with a letter.

## TABLE DIMENSIONS - PF400

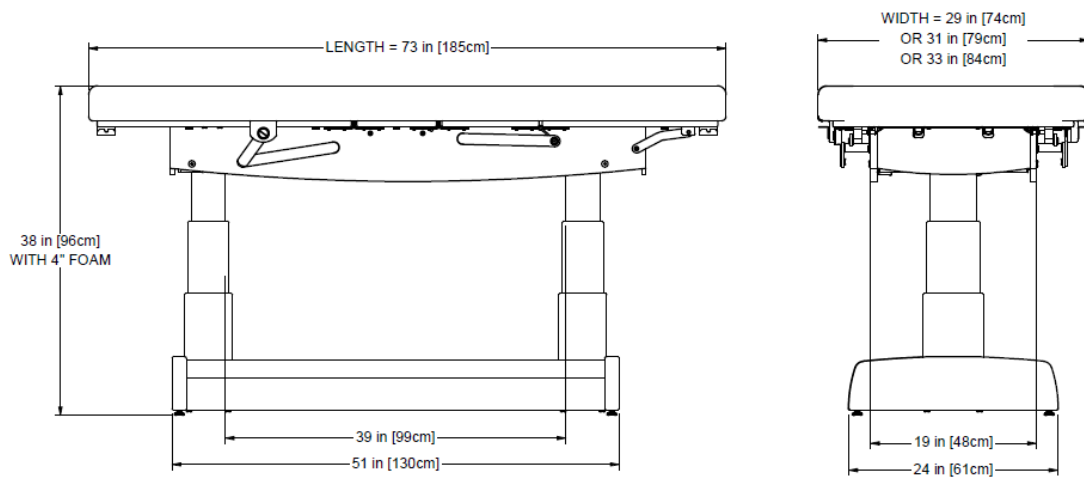

## TABLE DIMENSIONS - PF250

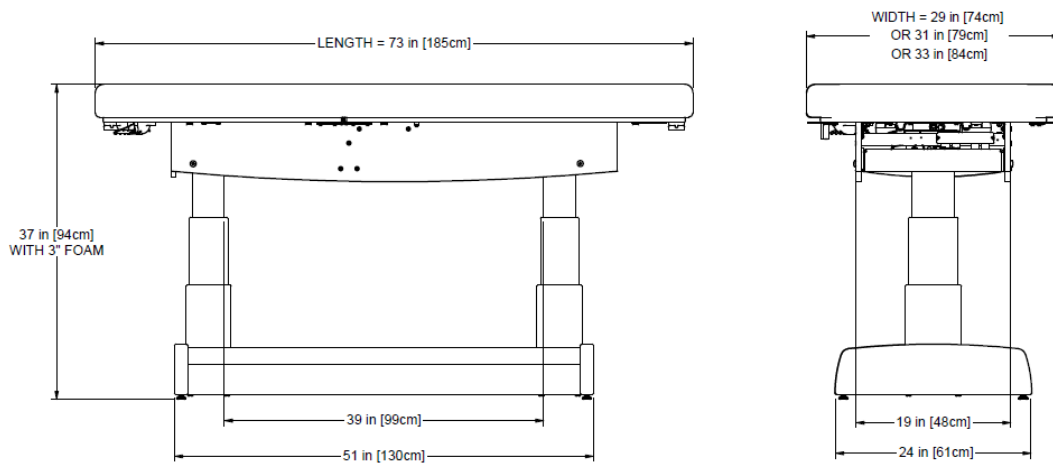

## SPECIFICATIONS

### PRODUCT SPECIFICATIONS

Weight	235 lbs. (107 kg.)
Lifting Capacity	550 lbs. (250 kg.)

### ENVIRONMENTAL CONDITIONS

Conditions	Temperature	Humidity	Atmospheric Pressure
Normal Use	50° (10°C) to 104° (40°C)	20% to 60% RH	98 to 105 kPa
Storage & Transport	-20° (-29°C) to 135° (57°C)	20% to 95% RH	98 to 105 kPa

### ELECTRICAL SPECIFICATIONS

Designed for:	North America	Europe
Input Service	120 VAC/15 amp/60 Hz	220 VAC/10 amp/50/60 Hz
Current Draw	4.0 amps	2.0 amps
Maximum Momentary Current Consumption	6.0 amps	3.0 amps
Voltage Output to Actuators	24 VDC	
Electric Shock Protection	Class 1 Equipment	
Tabletop Applied Part	 Type B Applied Part	
Ingress Protection Rating	IPX0	
Mode of Operation	Intermittent Operation MAX 2 minutes ON 18 minutes off	

## Guidance and manufacturer's declaration - electromagnetic emissions

The table is intended for use in the electromagnetic environment specified below. The customer or the user of the table should assure that it is used in such an environment.

Emissions Test	Compliance	Electromagnetic environment - guidance
RF emissions CISPR 11	Group 1	The table uses RF energy only for its internal function. Therefore, its RF emissions are very low and are not likely to cause any interference in nearby electronic equipment.
RF emissions CISPR 11	Class A	The table is suitable for use in all establishments other than domestic and those directly connected to the public low-voltage power supply network that supplies buildings used for domestic purposes.
Harmonic emissions IEC 61000-3-2	Class A	
Voltage fluctuations / flicker emissions IEC 61000-3-3	Complies	

## Recommended separation distances between portable and mobile RF communications equipment and the table

The table is intended for use in the electromagnetic environment in which radiated RF disturbances are controlled. The customer or the user of the table can help prevent electromagnetic interference by maintaining a minimum distance between portable and mobile RF communications equipment (transmitters) and the table as recommended below, according to the maximum output of the communications equipment.

Rated maximum output power of transmitter  W	Separation distance according to frequency of transmitter (m)		
	150 kHz to 80 MHz  $d = 1.2 \sqrt{P}$	80 MHz to 800 MHz  $d = 1.2 \sqrt{P}$	800 MHz to 2.5 GHz  $d = 2.3 \sqrt{P}$
0.01	0.12	0.12	0.23
0.1	0.38	0.37	0.73
1	1.2	1.2	2.3
10	3.8	3.8	7.3
100	12	12	23

For transmitters rated at a maximum output power not listed above, the recommended separation distance  $d$  in meters (m) can be estimated using the equation applicable to the frequency of the transmitter, where  $P$  is maximum output power rating of the transmitter in watts (W) according to the transmitter manufacturer.

NOTE 1 At 80 MHz and 800 MHz, the separation distance for the higher frequency range applies.

NOTE 2 These guidelines may not apply in all situations. Electromagnetic propagation is affected by absorption and reflection from structures, objects and people.

## SPECIFICATIONS

Guidance and manufacturer's declaration - electromagnetic immunity			
The table is intended for use in the electromagnetic environment specified below. The customer or the user of the table should assure that it is used in such an environment.			
Immunity Test	IEC 60601 test level	Compliance level	Electromagnetic Environment - guidance
Electrostatic discharge (ESD) IEC 61000-4-2	±6 kV contact ±8 kV air	±6 kV contact ±8 kV air	Floors should be wood, concrete or ceramic tile. If floors are covered with synthetic material, the relative humidity should be at least 30 %.
Electrical fast transient/burst IEC 61000-4-4	±2 kV for power supply lines ±1 kV for input/output lines	±2 kV for power supply lines Not applicable	Mains power quality should be that of a typical commercial or hospital environment.
Surge IEC 61000-4-5	±1 kV differential mode ±2 kV common mode	±1 kV differential mode ±2 kV common mode	Mains power quality should be that of a typical commercial or hospital environment.
Voltage dips, short interruptions and voltage variations on power supply input lines IEC 61000-4-11	<5 % UT (>95 % dip in UT) for 0,5 cycle  40 % UT (60 % dip in UT) for 5 cycles  70 % UT (30 % dip in UT) for 25 cycles  <5 % UT (>95 % dip in UT) for 5 sec.	<5 % UT (>95 % dip in UT) for 0,5 cycle  40 % UT (60 % dip in UT) for 5 cycles  70 % UT (30 % dip in UT) for 25 cycles  <5 % UT (>95 % dip in UT) for 5 sec.	Mains power quality should be that of a typical commercial or hospital environment. If the user of the table requires continued operation during power mains interruptions, it is recommended that the table be powered from an uninterruptible power supply or a battery.
Power frequency (50/60 Hz) magnetic field IEC 61000-4-8	3 A / m	3 A / m	Power frequency magnetic fields should be at levels characteristic of a typical location in a typical commercial or hospital environment.
NOTE U <sub>T</sub> is the a.c. mains voltage prior to application of the test level.			



# SPECIFICATIONS

## Guidance and manufacturer's declaration - electromagnetic immunity

The table is intended for use in the electromagnetic environment specified below. The customer or the user of the table should assure that it is used in such an environment.

Immunity Test	IEC 60601 test level	Compliance level	Electromagnetic Environment - guidance
Conducted RF IEC 61000-4-6	3 Vrms 150 kHz to 80 MHz	3Vrms	<p>Portable and mobile RF communications equipment should be used no closer to any part of the table, including cables, than the recommended separation distance calculated from the equation applicable to the frequency of the transmitter.</p> <p>Recommended separation distance</p> $d = 1.2 \sqrt{P}$ <p> <math>d = 1.2 \sqrt{P}</math> 80 MHz to 800 MHz  <math>d = 2.3 \sqrt{P}</math> 800 MHz to 2,5 GHz                 </p> <p>Where P is the maximum output power rating of the transmitter in watts (W) according to the transmitter manufacturer and d is the recommended separation distance in meters (m).</p> <p>Field strengths from fixed RF transmitters, as determined by an electromagnetic site survey, <sup>a</sup>should be less than the compliance level in each frequency range. <sup>b</sup></p> <p>Interference may occur in the vicinity of equipment marked with the following symbol:</p> 
Radiated RF IEC 61000-4-3	3 V/m 80 MHz to 2,5 GHz	3V/m	

NOTE 1 At 80 MHz and 800 MHz, the higher frequency range applies.

NOTE 2 These guidelines may not apply in all situations. Electromagnetic propagation is affected by absorption and reflection from structures, objects and people.

<sup>a</sup> Field strengths from fixed transmitters, such as base stations for radio (cellular/cordless) telephones and land mobile radios, amateur radio, AM and FM radio broadcast and TV broadcast cannot be predicted theoretically with accuracy. To assess the electromagnetic environment due to fixed RF transmitters, an electromagnetic site survey should be considered. If the measured field strength in the location in which the table is used exceeds the applicable RF compliance level above, the table should be observed to verify normal operation. If abnormal performance is observed, additional measures may be necessary, such as re-orienting or relocating the table

<sup>b</sup> Over the frequency range 150 kHz to 80 MHz, field strengths should be less than 3/m.

---

THIS PAGE IS INTENTIONALLY LEFT BLANK

---

THIS PAGE IS INTENTIONALLY LEFT BLANK

# USER MANUAL

---

# OAKWORKS®

## PF Series Tables

---



**Intertek**  
3034177

CONFORMS TO:  
ANSI/AAMI STD ES60601-1  
IEC STD 60601-1 3RD EDITION  
IEC STD 60601-1-2 3RD EDITION  
IEC STD 60601-1-6 3RD EDITION  
CERTIFIED TO CAN/CSA STD C22.2 NO. 60601-1  
CB TEST CERTIFICATE AND REPORT

Original Instructions  
Manual Part Number: Med-RA-PM-155  
Revision Level: 6  
Revision Date: 07/22/2022

English, Printed in USA

