

Pressalit 2000
Fixed Height Changing Table
R8425418000: Coated Canvas Mattress
(Model 2100)
R8425218000: Removable Mesh Mattress

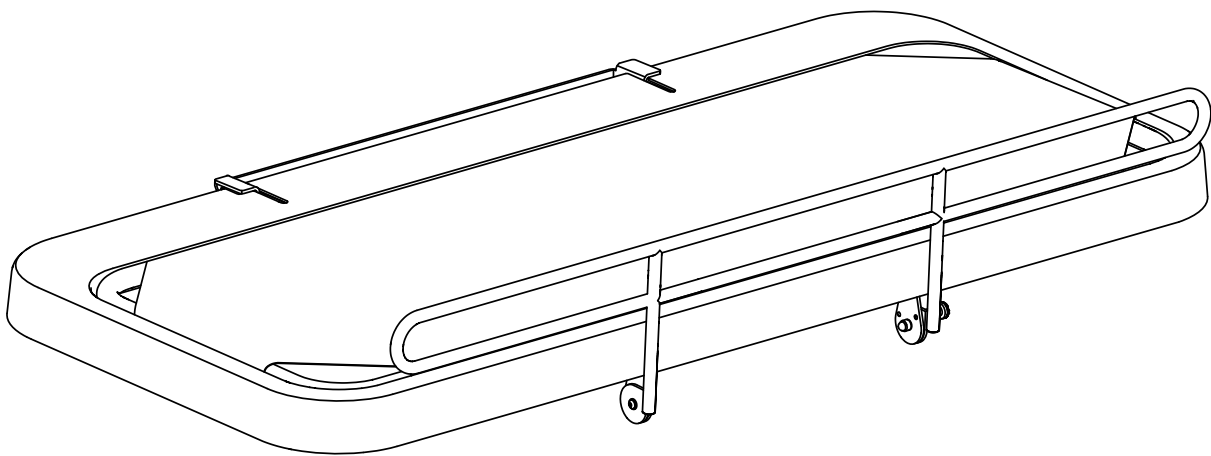

Find more product information on our website.

Subject to change without further notice.

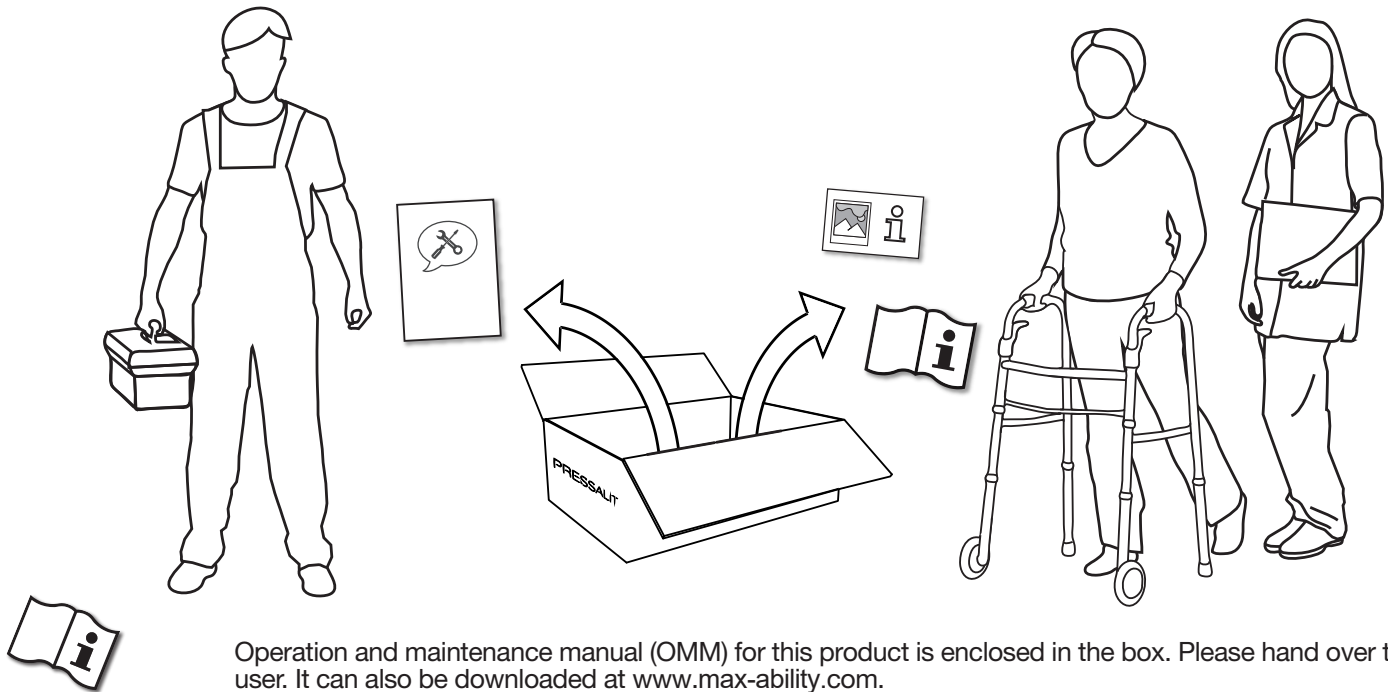

Operation and maintenance manual (OMM) for this product is enclosed in the box. Please hand over to the user. It can also be downloaded at www.max-ability.com.

An operation signage (quick guide) for use by people with reading or cognitive disabilities, is enclosed in the box. It can also be downloaded at www.max-ability.com. User information is not available in braille.

Mounting Instruction

Please read and carefully follow these instructions. Find the product number on the product label and ensure that these assembly instructions match your product.

WARNING: Failure to comply with these instructions may result in accidents involving serious personal injury or the product being damaged.



WARNING: If you suspect that any individual parts may be damaged, contact your Pressalit dealer or service provider. Do not remove, attempt to repair or install parts yourself, unless directed to do so by Pressalit or its agents.

WARNING: No modification of this equipment is allowed without express authorization from Pressalit.

WARNING: These instructions must be followed, and the product must be installed professionally by a qualified person; e.g. a licensed plumber, in order to avoid personal injury or property damage while using the product.

WARNING: Pressalit cannot be held liable for injury to persons or damage to property caused by faulty mounting.

Installation location

This product is designed for indoor use in a wet environment, such as a bathroom or washroom. When choosing an installation location, ensure that there will be adequate space for access to the product.

Assembly and installation

Mount the product in accordance with the illustrations in this assembly instruction. Contact MAX-Ability if assistance is needed when installing the product.

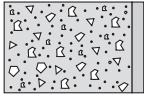

Concrete >B25

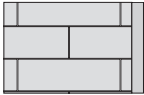
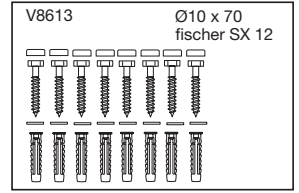

Solid Brick >= Mz12

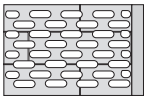
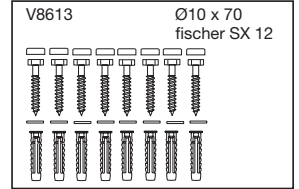

Solid Sand Lime Brick >= Hlz12

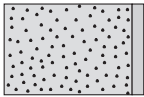
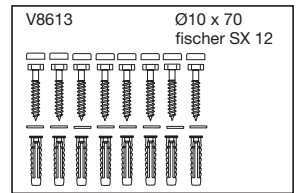

Aerated Concrete P4

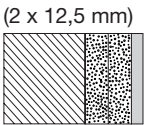
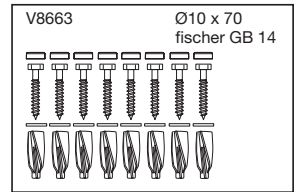

Drywall water-resistant, re-enforced with wood

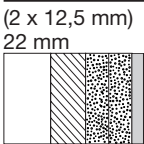
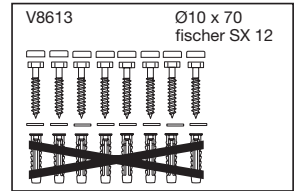

Drywall water-resistant, re-enforced with plywood

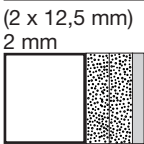
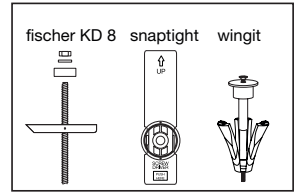

Drywall water-resistant, re-enforced with steel plates

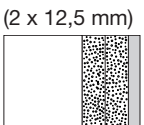
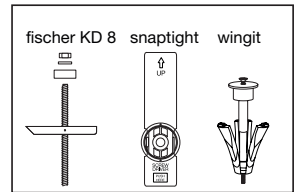

Drywall water-resistant



Concrete anchors included at no additional charge.

