

# Prone Stander

E930, E940 & E950 Product Manual



# Contents

---

Important information and check your order	3
Safety messages	4
Recommended use and item dimensions	5
Basic components for small (E930)	
Main board	6
Footboard	7
Kneeboard	7
Basic components for medium (E940)	
Main board	8
Footboard	9
Basic components for large (E950)	
Main board	10
Footboard	11
Accessories	
Abductors	12-13
Tray	14
Hand Anchor	15
Sandals & wedges	16
Operation	17
Maintenance, cleaning and warranty	18
Materials and user modifications	19

## IMPORTANT

Please save this product manual for future reference. Additional copies are available at [www.rifton.com](http://www.rifton.com)

## Key for users

Use this key to determine which sections of this product manual apply to you.



**Technical Users** For professionals who order and set up Rifton products.



**Home Users** For care-givers who use Rifton products on a regular basis.



**Maintenance Personnel** For anyone who is responsible for service or re-ordering of Rifton products and parts.

## Check your order

This product is shipped in a single carton. The carton contains:

1. Prone Stander (includes: pair of lateral support blocks, hip strap, and footboard).
2. Tray (if ordered).
3. Carton containing footboard (E950 only) and accessories for the Prone Stander.

You may not have ordered all of the available accessories, but use the following diagrams to make sure your order is complete.

## **WARNING**



- Thoroughly read and understand the information in this product manual before attempting to use this product. If the procedures and instructions in this product manual are not followed, serious injury or death could occur.
- A qualified professional must assess the appropriateness and safety of all equipment for each user.
- This product is intended for use by clients of unreliable judgment. Adult supervision is required at all times.
- To prevent falls and injuries:
  - Do not use this product on rough and uneven terrain, around swimming pools, or near stairways.
  - Ensure the appropriate use of straps and supports at all times. Straps and supports are provided for the safety of the user and must be carefully adjusted for comfort and security.
  - Tighten all adjustment knobs before use and immediately after making any adjustments.
  - Lock all four casters before placing a client into or removing a client from the product.
  - Have two adults assist with transfer into or out of the Prone Stander for added safety.
- Do not use this product for clients outside the height and weight limits specified in this manual.
- To prevent tipping and resulting injury, use the Rifton Prone Stander indoors only.
- To prevent structural failure, which may result in serious injury or death:
  - Inspect this product and accessories regularly for loose or missing screws, metal fatigue, cracks, broken welds, missing attachments, general instability or other signs of excessive wear.
  - Immediately remove this product from use when any condition develops that might make operation unsafe.
  - Do not use Rifton components or products for any purpose other than their intended use.

## Recommended use



**To prevent falls, do not use the Prone Stander as a transportation device.**

The Prone Stander is a Class 1 medical device. It provides the benefits of weight-bearing in an upright posture, abdomen toward the main board. Adjustable supports promote proper alignment of trunk and lower extremities. The board tilts from vertical to horizontal with a crank. The tray provides a convenient space for a communication device or other activity, and has a tool-free angle adjustment.

## User and item dimensions

User dimensions—inches (cm)	small	medium	large
Height	25–48 (64–122)	44–59 (112–150)	57–72 (145–183)



**Key user dimension: height**

Select the appropriate Prone Stander by the user’s overall height. Choose the model that allows for growth.

**Important:** User’s weight must not exceed the maximum working load.

Dimensions – inches (cm)	E930 small	E940 medium	E950 large
Board length	23½ – 16 without kneeboard 60 – 41 with kneeboard	30 (76)	39 (99)
Board width (top/bottom)	12½ / 12½ (32 / 32)	11 / 16 (28 / 41)	15 / 19 (38 / 48)
Top of board to footboard	18–35 (46–89)	33–43½ (84–110)	42–55 (38 / 48)
Height when horizontal	29½ (75)	29½ (75)	31½ (80)
Height when vertical	38½ (98)	45½ (116)	60 (152)
Distance between lateral supports	8–16 (20–41)	8–16 (20–41)	12–22 (30–56)
Base width	24 (61)	26 (66)	30 (76)
Base length	35 (89)	39 (99)	43 (109)
Tray inside width (widest point)	22½ (57)	22½ (57)	29½ (75)
Tray inside length	17½ (44)	17½ (44)	17½ (44)
Max. working load in lbs (kg)	100 (45)	150 (68)	200 (91)

# Basic components for small (E930)

## Main board

### Trunk lateral blocks

Lateral blocks (A) ship in reverse position.

To reposition lateral blocks:

- Loosen knobs (C) and slide blocks out from under the clamp (see Figure 6b).
- Rotate blocks into correct position and replace them under the clamp.
- Retighten knobs (see Figure 6b).

Use knobs (C) to adjust the blocks laterally and vertically, and to pivot them approximately 30°.

Make sure lateral blocks are clear of tray when adjusting board angle.

### Support straps

To reposition support straps (B):

- Loosen knobs (D).
- Slide straps up or down.
- Retighten knobs.

### Board positioning

The main board, kneeboard, and footboard slide independently on a tubular steel track, clamping with knob (E).

### Board tilt

The angle of the board is controlled by a handcrank (F). This sets the board at any angle from horizontal to vertical. Adjustments can take place at any time once the user is secure.

The board position indicator (G) is a direct angle indicator that is attached at the pivot point.

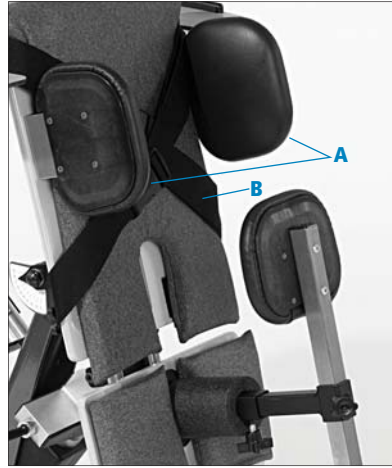

Figure 6a. Main board of E930 Prone Stander, with round abductor with hip stabilizer installed.

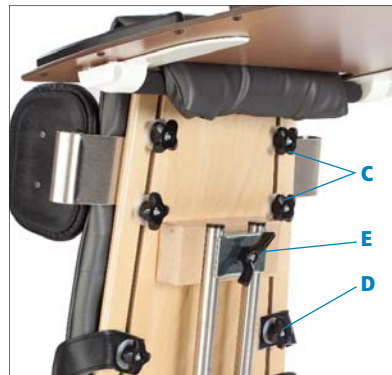

Figure 6b

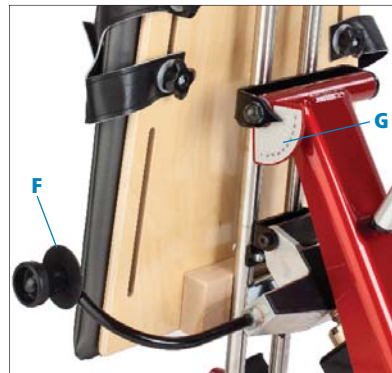

Figure 6c

## Footboard

The footboard is shipped in the reverse position on the tube.

Reposition by removing knob (A) and clamp (B). Rotate footboard into correct position, replace clamp and knob and retighten (see Figure 7a).

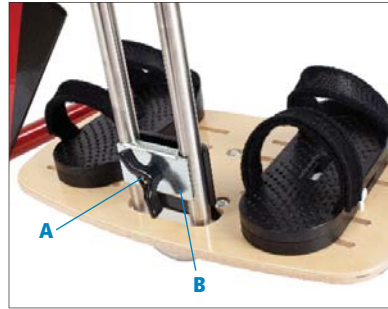

Figure 7a

## Kneeboard

To remove the kneeboard for small children, loosen knob (C) until the plated clamp can rotate 90°, freeing the kneeboard. If abductors were used on the kneeboard attach them to the main board. Lower the main board to its lowest position, and raise the footboard so that the top of the main board reaches the user's chest.

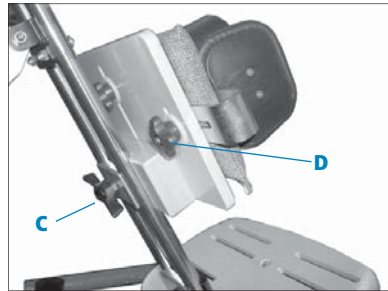

Figure 7b

**Tip:** When replacing the kneeboard, the wooden clamp block goes down, and the slot for abductors up (see Figure 7b).

## Knee lateral blocks

To attach the knee lateral blocks, loosen knobs (D), slide lateral blocks onto kneeboard and retighten knobs.

Knee lateral blocks can also be adjusted vertically using knobs (D).



Figure 7c

Figure 7c shows the kneeboard with knee lateral blocks and round abduction block. Abduction blocks can be attached on the main board or on the kneeboard.

# Basic components for medium (E940)

## Main board

### Trunk lateral blocks

Lateral blocks (A) ship in reverse position.

1. To reposition lateral blocks:

- Loosen knobs (C) and slide blocks out from under the clamp.
- Rotate blocks into correct position and replace them under the clamp.
- Retighten knobs (see Figure 8b).

2. Extra set of lateral blocks are installed in the same manner

Use knobs (C) to adjust lateral blocks laterally and vertically, and to pivot blocks approximately 30°.

Make sure lateral blocks are clear of tray when adjusting board angle.

### Hip strap

Hip strap (B) attaches with knobs (D). Slide up or down for best location. Strap can be positioned above or below lateral blocks.

### Board position

The main board slides independently on a tubular steel track, clamping with knob (E).

### Board tilt

The angle of the board is controlled by a handcrank (F). This sets the board at any angle from horizontal to vertical. Adjustments can take place at any time once the user is secure.

The board position indicator (G) is a direct angle indicator that is attached at the pivot point.

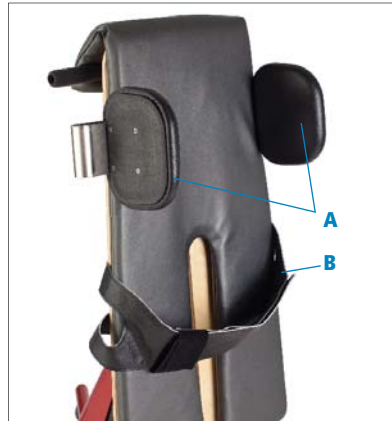

Figure 8a

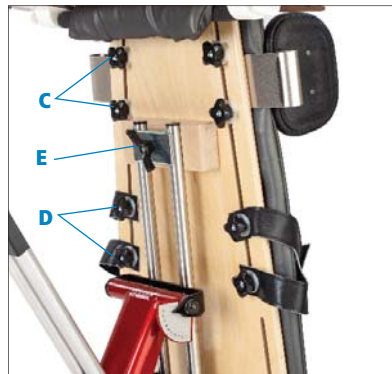

Figure 8b



Figure 8c



## Footboard

The footboard is shipped attached in the reverse position to the stander. Reposition by removing knob (A) and clamp (B). Rotate footboard into correct position, replace clamp and knob and retighten.

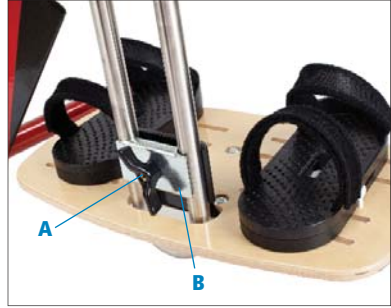

Figure 9a

# Basic components for large (E950)

## Main board

### Trunk lateral blocks (see Figure 10b)

Lateral blocks (A) ship in reverse position.

1. To reposition lateral blocks:
  - Loosen knobs (C) and slide blocks out from under the clamp.
  - Rotate blocks into correct position and replace them under the clamp.
  - Retighten knobs.
2. Extra set of lateral blocks are attached in the same manner.

Use knobs (C) to adjust lateral blocks laterally and vertically, and to pivot blocks approximately 30°.

Make sure lateral blocks are clear of tray when adjusting board angle.

### Hip strap (see Figures 10a and 10b)

Hip strap (B) attaches with knobs (D). Slide up or down for best location. Strap can be positioned above or below support blocks.

### Board tilt (see Figure 10c)

The angle of the board is controlled by a handcrank (F). This sets the board at any angle from horizontal to vertical. Adjustments can take place at any time once the user is secure.

The board position indicator (G) is a direct angle indicator that is attached at the pivot point.

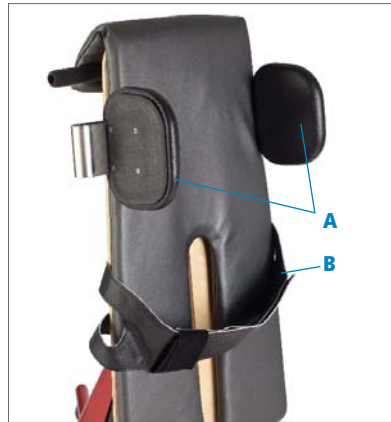

Figure 10a

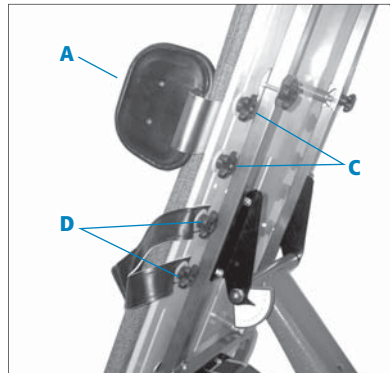

Figure 10b

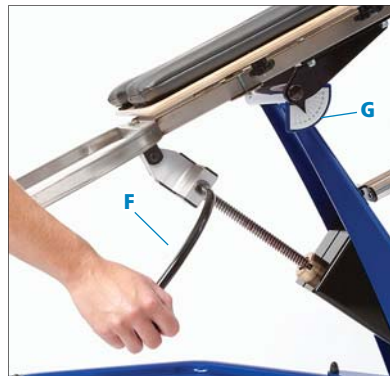

Figure 10c

## Footboard

Unpack footboard and slide it up onto square tubing of frame. Push spring buttons (A) at ends of frame legs so that footboard tubes slide over them.

**Tip:** The single slot on the footboard should face out, away from the main board.

The footboard adjusts vertically, sliding on the square tubing of the frame. Spring buttons (A) in the frame lock the footboard at different heights.

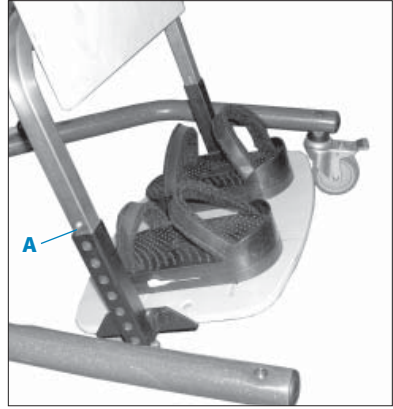

Figure 11a

# Accessories

## Abductors

### Round abduction block

To attach the round abduction block (see Figure 12a), remove the knob and place abductor where appropriate. Retighten knobs securely.



Figure 12a

Depending on the need of the user, the positioning of the abduction block will vary. Check the range of adjustment before positioning the user.

### Collar for round abduction block

To attach the collar (see Figure 12b) to the round abduction block, wrap around and fasten snaps.



Figure 12b

### Knee lateral blocks

Attach the knee blocks (see Figure 12c) by removing knobs (E) and tightening behind board, with washer between knob and board.

Knee blocks can be repositioned using knobs (E).

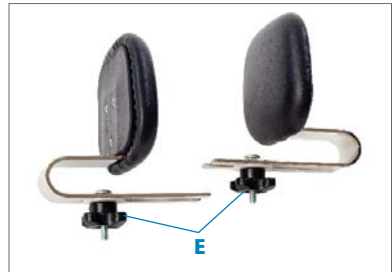

Figure 12c

### Adjustable abduction wedge

(see page 13)

To attach the adjustable abduction wedge to the Stander (see Figure 12d), remove the knob and one washer off each threaded stud. Place the abduction wedge in the appropriate slot with one washer on each threaded stud between the abduction wedge and the Prone Stander. Replace washers and knobs on the threaded studs underneath board and tighten securely.

To adjust the width of abduction, raise one wing of the wedge to expose the adjustment screw (A). Turn screw out to increase abduction. Raise the second wing and adjust it in the same way.



Figure 12d

### **Adjustable abduction wedge with hip stabilizer**

**E940 & E950** (see Figure 13a)

Remove knobs and washers (B) from threaded studs. With knob (D) pointing down, slide threaded studs through appropriate slot in board. Replace knobs and washers on threaded studs at the back of the board and tighten firmly.

Adjust vertically using knobs (B). Move hip stabilizer horizontally by loosening and securing knob (D). Vertical adjustments to the hip stabilizer only are controlled by knob (C).

Adjust the amount of abduction by shortening or lengthening the adjustment screws underneath the wings of the adjustment wedge (see Figure 12d).

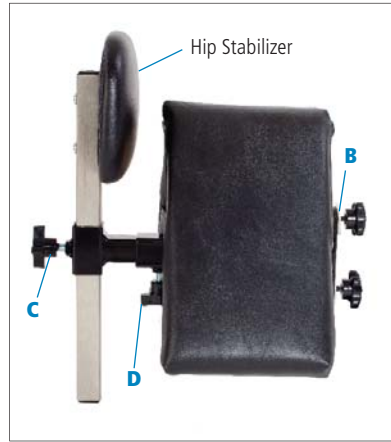

Figure 13a

### **Round abductor with hip stabilizer**

**E930 & E940** (see Figure 13b)

Remove knobs and washers (A). Attach the two bolts (B) on the Prone Stander where appropriate, with knob (C) pointing down. Replace washers and knobs behind the board and tighten.

Adjust vertically using knobs (A). Move hip stabilizer horizontally by loosening and securing knob (C). Vertical adjustments to the hip stabilizer only are controlled by knob (D).

The round abductor with hip stabilizer may be attached to the board before or after positioning the user. Once the round abductor is attached, the hip stabilizer can be removed for transfers by loosening knob (D).

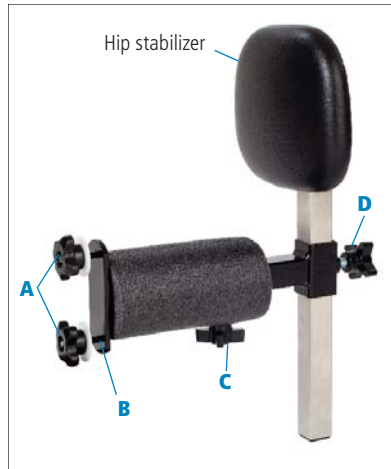

Figure 13b

Position the abductor between the thighs above the knees. The correct position for the hip stabilizer is at the back of the hips (sacral area), snug enough to keep the hips against the board.

## Tray

### Attaching the tray:

(see Figures 14a, 14b & 14c)

1. Lock the casters.
2. Turn the handcrank until the Prone Stander is nearly vertical.
3. Hold the tray in front of you with the adjustable brace (A) down.
4. Place the hook (B) into the slot on the mast of the Stander.
5. Hold the tray by the latches and pull latch handles out (C). Clip latches into ends of black tubular cross piece (D) at the top of main board.
6. Make sure that tray is securely fastened and latches are clipped in place.

### Adjusting the tray:

Use knob (A) to adjust the angle of the tray. Be sure to tighten knob securely after adjusting.

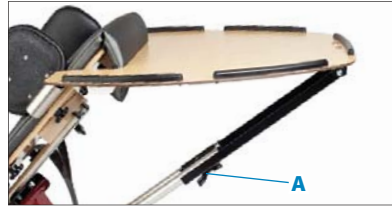

Figure 14a

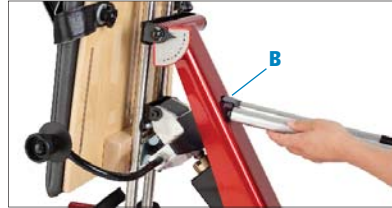

Figure 14b. Tray hook going into slot on mast

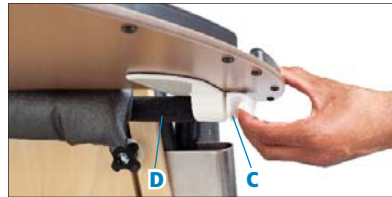

Figure 14c

## Hand Anchor

**⚠️ WARNING** To prevent falls and resulting injury, do not use Rifton Anchors as a primary support or as a standing support. Suction cups may release.

To prevent falls and cuts, do not use Rifton Anchors on thin glass.

### Recommended use

Hand Anchors can be used on the Prone Stander tray. They give the client an anchor to control excessive movement of the arms and encourage stabilization of the shoulder girdle. The client may hold on with both hands for stabilization training or with one hand keeping the other hand free.

### Operation

On a clean smooth Rifton tray, press down on suction cup of hand Anchor and turn handhold clockwise until secure. To remove, turn handhold counterclockwise.

**Tip:** Surface must be very smooth and completely clean to get a strong seal. If suction cup does not hold well, wipe with a damp cloth or apply a thin layer of petroleum jelly around the rim of the rubber pad to enhance the vacuum.



Figure 15a

## Sandals and wedges

(See Figures 11a and 11b)

### Attaching sandals:

1. Remove washers and knobs (C) from sandal. Insert bolts through slots in footboard.
2. Replace washers and knobs and tighten securely (C).

### To adjust sandals:

1. Loosen the knobs (C).
2. Move the sandals to the desired position.
3. Retighten the knobs.
4. The sandal height can be built up, or a toe/heel angle achieved, by using one or more wedges.

### Adding sandal wedges:

1. Unlatch white latch (D) and remove the sandal from the base.
2. Place the wedge over the base and latch it into place. Any number of wedges can be added.
3. Put the sandal on top, and latch it.



Figure 11a

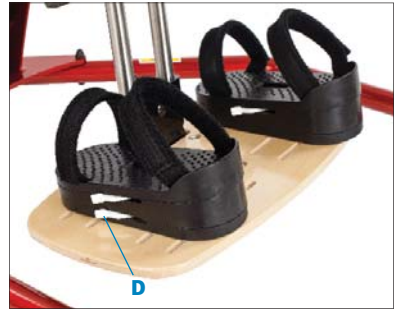

Figure 11b



# Operation

**▲ WARNING** To prevent falls or injury:

- **Keep all four casters locked at all times except when moving the Prone Stander, whether or not the Stander is occupied.**
  - **Ensure that all four casters are locked when transferring a client.**
  - **For heavy or larger clients, two caregivers may be needed to safely transfer the client in or out of the Stander.**
  - **Ensure that all straps are securely fastened.**
  - **Never leave client unattended.**
1. Lock all casters and set the footboard height to an approximate position, as low as possible for the user's sense of security. The top of the main board should reach the user's chest.
  2. Crank main board to appropriate angle. This depends on whether the user is transferring from a bed, wheelchair, or other position.
  3. Open straps on main board and move lateral blocks out as far as possible.
  4. Set sandals to approximate positions and open the straps.
  5. Assist the user to standing position with the help of a second person if appropriate. Maintain complete support as you fasten the hook-and-loop straps.
  6. Position lateral blocks as required.
  7. Fine-tune all adjustments, starting with the sandals. Tighten all knobs.
  8. Adjustment of the tilt angle with the handcrank can take place at any time once the user is securely in the Stander.
  9. Support blocks can be attached at the same vertical position as the straps. Move the support blocks from under their original clamp to the clamp for the straps by sliding the bracket under the strap clamp and tightening the knobs.

## Maintenance

This product is designed and tested for an expected life of 5 years when used and maintained in accordance with this manual. At all times, users must ensure that the product remains in a safe and useable condition, including regular maintenance and inspections as specified in this manual.

To prevent structural failure, which may result in serious injury or death:

- Inspect this product and accessories regularly for loose or missing screws, metal fatigue, cracks, broken welds, missing attachments, general instability or other signs of excessive wear.
- Immediately remove this product from use when any condition develops that might make operation unsafe.
- Do not use Rifton components or products for any purpose other than their intended use.
- Replace or repair components or products that are damaged or appear to be unstable.
- Use only Rifton authorized replacement parts. Order information for replacement parts is provided on the back of this product manual.

Every month, check lubrication of the threaded rod which drives tilting mechanism. If it seems dry, apply general purpose grease with a brush to the length of the rod.

Twice a year check bolts securing crosspieces of frame and tighten if necessary.

## Cleaning

Clean with disinfectant wipes or a solution of up to 10% bleach. The straps, sandals and pads are removable for cleaning.

## Warranty Statement

If a Rifton product breaks or fails in service during the first year, we will replace it free of charge.

# Materials

- Steel hardware items (nuts, bolts, screws, etc) are typically zinc or nickel plated, or stainless steel.
- Upholstery items (pads, support blocks, padded prompts, etc) are typically polyurethane foam with a fire-retardant cover made from expanded vinyl.
- Frames are typically steel or aluminum tubing, welded together, and coated with a baked-on paint finish. Some frame components may also be stainless steel.
- Straps are typically made of polypropylene or nylon webbing.
- Wooden components are typically birch plywood, solid maple, or laminated hardwood veneers, finished with a clear polyurethane lacquer.
- Plastic components are typically injection molded from a variety of industrial resins.

All materials are latex, lead and phthalates free.

# User modifications

** WARNING** To prevent serious injury or death, do not modify or alter Rifton products or components, or use Rifton products or components in conjunction with products from other manufacturers. Rifton does not accept responsibility for any modifications or alterations made to our components or products after they leave our premises. Customers modifying or altering our components or products, or using them in conjunction with products from other manufacturers, do so at their own risk.