

PT Line & Orthopedic Hi-Lo Casting Table



Orthopedic
Hi-Lo Casting
Table

Manual Part # MMMNST009
1st Edition, March 2009
Printed in U.S.A.

All rights are reserved. No part of this document may be photocopied, reproduced or translated to another language without prior written consent of OAKWORKS®, Inc.

OAKWORKS® is a registered trademark of OAKWORKS®, Inc.

Notice

The information contained in this document is subject to change without notice and should not be construed as a commitment by OAKWORKS®, Inc.

OAKWORKS®, Inc. assumes no responsibility for any errors that may appear in this document nor does it make expressed or implied warranty of any kind with regard to this material, including, but not limited to, the implied warranties of merchantability and fitness for a particular purpose.

OAKWORKS®, Inc. shall not be liable for incidental or consequential damages in connection with or arising out of the furnishing, performance, or use of this document and the program material which it describes.

TABLE OF CONTENTS

Warnings & Symbol Identification	pg 1
Section I: Product Descriptions & Photos	
PT100	pg 3
PT200	pg 4
PT300	pg 5
Orthopedic Hi-Lo Casting Table	pg 6
Section II: Directions for Use	
Adjusting the Table Height	pg 7
Adjusting the Backrest	pg 8
Adjusting the Articulating Head Rest	pg 9
Adjusting the Optiona Security Side Rail	pg 11
Moving the Table	pg 12
QuickLock™ Face Rest	pg 13
Section III: Care & Cleaning	pg 16
Section IV: Specifications	pg 17
Section V: Product Identification	pg 19
Section VI: Warranty	pg 20
Contact Information	Back Cover

SYMBOL IDENTIFICATION

SYMBOL IDENTIFICATION



This symbol, when used in this manual and on product labels, represents a caution. Be sure to read and comply with all precautions and warnings.



This symbol, when used in documentation on this product, indicates danger and warns against an electrical shock hazard. Be sure to observe and comply with all warnings and instructions.



This symbol, when used in documentation on this product, indicates a Protective Earth (Ground) Terminal.



This symbol when used in documentation on this product, warns that during transport there should be no stacking of containers.



This symbol, when used in documentation on this product, indicates that the product should be protected from moisture. The humidity specifications for Transport & Storage are listed in the back of this manual.



This symbol, when used in documentation on this product, indicates that information is given regarding the recommended temperature limits during transport and storing. The specifications for these limits are listed in the back of this manual.



This symbol, when used in documentation on this product, indicates the date of manufacture of the device.



This symbol, when used in documentation on this product, indicates alternating current (AC).



This symbol, when used in documentation on this product, indicates direct current (DC).



This symbol, when used in documentation on this product, indicates that instructional information is included. All instructions should be read carefully and completely before using the equipment.

WARNINGS & IMPORTANT SAFETY INSTRUCTIONS

WARNINGS

 **IMPORTANT**

 **CAUTION**

 **CAUTION**

 **DANGER**

 **WARNING**

Be sure to read all cautions, warnings and operating instructions prior to use to prevent injury to both operator and client.

Weight limit (including patient and accessories): 550 lbs.

Be certain that the equipment is completely lowered without any tilt being present prior to discharging an ambulatory patient. The patient may lose balance and fall. Care should be taken.

Electrical Shock Hazard. The power supply/control module is located below the base of the table. No user serviceable parts are inside. Refer servicing to qualified personnel. Before doing any work on the unit or cleaning with any liquid cleaner, unplug wall connector prior to contact with any cables connected to the power supply.

This product is for use on a nominal 120-volt circuit in North America (220-volt in Europe) and has a grounding plug that looks like the plug illustrated below (see Figure A). Make sure that the product is connected to an outlet having the same configuration as the plug. No adapter should be used with this product.

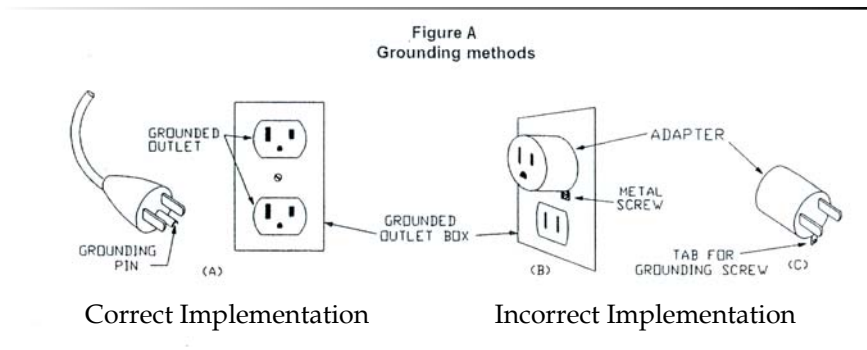

 **CAUTION**

 **CAUTION**

 **CAUTION**

The table weighs as much as 175 lbs. **DO NOT** turn the unit on its side without using proper safety procedures.

DO NOT put excessive weight or pressure on the Face Rest or Table Extender. **DO NOT** extend the dowels further than 3" from the table edge to insure a stable connection.

Pinch points - keep fingers and hands away from underside of table top.

PRODUCT DESCRIPTION

PT100

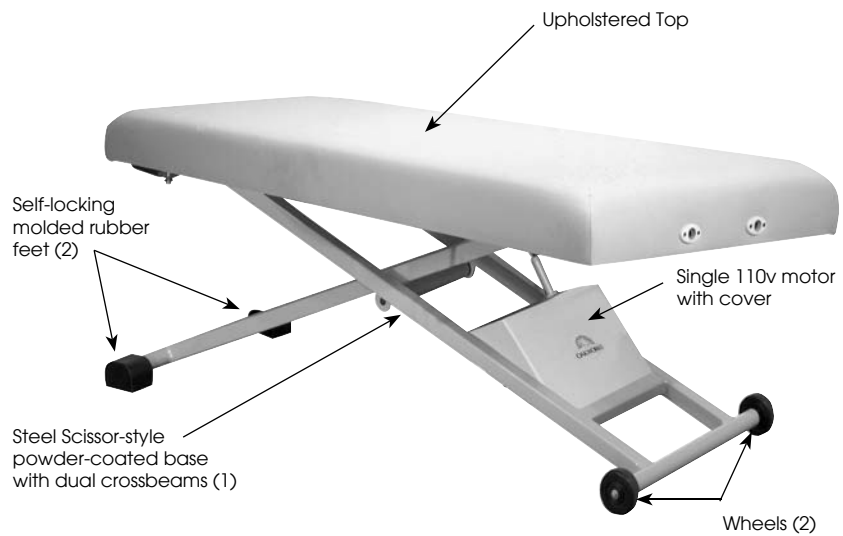

Table Specs*

- Height: 17" - 35" (43cm - 88cm)
- Width: 29" (74 cm)
- Length: 73", 75" (185 cm, 190 cm)
- Lift Capacity: 550 lbs. (249 kg)
- Weight: 190 lbs. (86.2 kg)
- Top: Rectangular, Backrest, Flex
- Padding: Medical Grade
- Upholstery: TerraTouch™ (standard), Tufflex™ (optional)
- Electronics: single 110 volt motor, 1 low voltage foot control, 1 low voltage hand control

For electrical specs, see Specifications Chart in the back of this manual.

- published weight may differ due to options chosen, natural material variations and padding density

PRODUCT DESCRIPTION

PT200

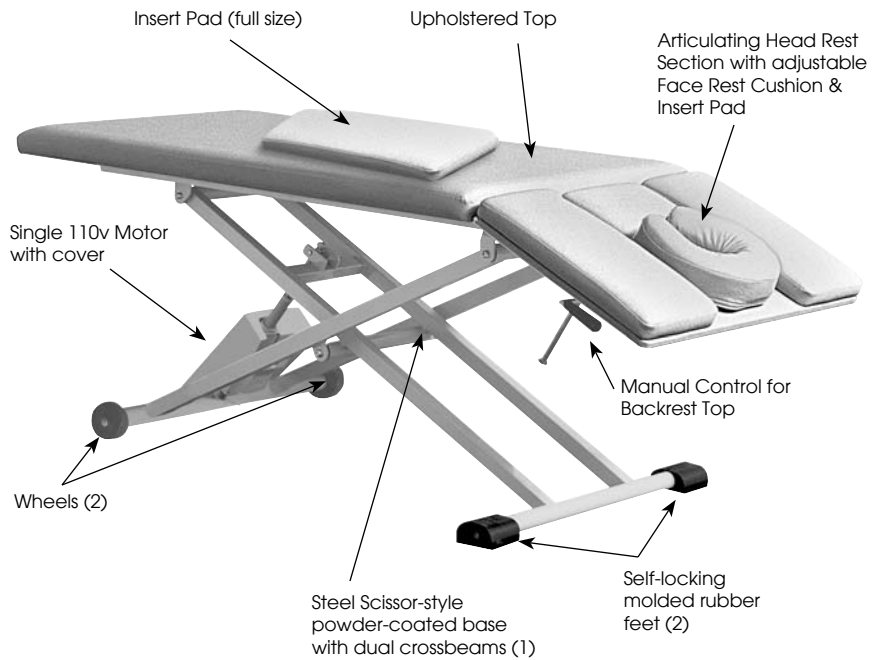

Table Specs*

- Height: 17" - 35" (43cm - 88cm)
- Width: 27", 29", 31" (69 cm, 74 cm, 79 cm)
- Length: 75" (190 cm)
- Lift Capacity: 550 lbs. (249 kg)
- Weight: 175 lbs. (79 kg)
- Top: Articulating Top
- Padding: Medical Grade
- Upholstery: TerraTouch™ (standard), Tufflex™ (optional)
- Electronics: single 110 volt motor, 1 low voltage foot control, 1 low voltage hand control

For electrical specs, see Specifications Chart in the back of this manual.

- published weight may differ due to options chosen, natural material variations and padding density

PRODUCT DESCRIPTION

PT300

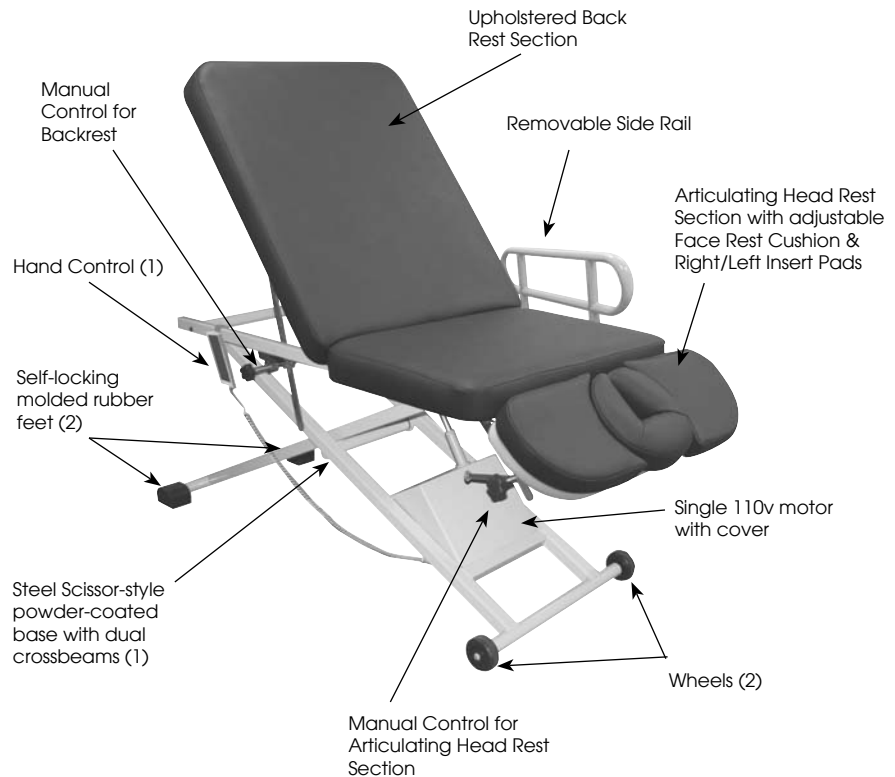

Table Specs*

- Height: 17" - 35" (43cm - 88cm)
- Width: 27", 29", 31" (69 cm, 74 cm, 79 cm)
- Length: 73" (185 cm)
- Lift Capacity: 550 lbs. (249 kg)
- Weight: 175 lbs. (79 kg)
- Top: Articulating Top
- Padding: Medical Grade
- Upholstery: TerraTouch™ (standard), Tufflex™ (optional)
- Electronics: single 110 volt motor, 1 low voltage foot control, 1 low voltage hand control

For electrical specs, see Specifications Chart in the back of this manual.

- published weight may differ due to options chosen, natural material variations and padding density

PRODUCT DESCRIPTION

Orthopedic Hi-Lo Casting Table



Table Specs*

- Height: 17" - 35" (43cm - 88cm)
- Width: 31" (79 cm)
- Length: 73" (185 cm)
- Lift Capacity: 550 lbs. (249 kg)
- Weight: 175 lbs. (79 kg)
- Top: Articulating Top
- Padding: Medical Grade
- Upholstery: TerraTouch™ (standard), Tufflex™ (optional)
- Electronics: single 110 volt motor, 1 low voltage foot control, 1 low voltage hand control

For electrical specs, see Specifications Chart in the back of this manual.

- published weight may differ due to options chosen, natural material variations and padding density

DIRECTIONS FOR USE

- Adjusting the height of the the table

DIRECTIONS FOR USE



IMPORTANT

Be sure to read all cautions, warnings and instructions given in the manual to prevent injury to both operator and client.



CAUTION

The table weighs as much as 175 lbs. *DO NOT* turn the unit on its side without using proper safety procedures.



CAUTION

When operating the controls on any of the PT Series tables be sure to observe all cautions and warnings given in the manual to prevent injury to both operator and client.

IMPORTANT

Be sure self-locking molded rubber feet are flat side down to ensure safety and stability.



Adjusting the Height of the Table:

The OAKWORKS® PT Series and Orthopedic Hi-Lo Casting table offers height positioning with electronic ease. The tables come with 1 foot control and 1 hand control for multi-functional positioning.

Foot Control (used only to change height of table; operation the same on all tables; table shown here: PT300)

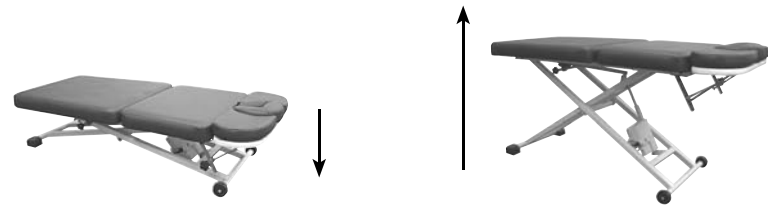

DOWN
Step lightly until desired height is reached; then stop.



UP
Step lightly until desired height is reached; then stop.

Hand Control (used only to change height of table; operation the same on all tables; table shown here: PT300)

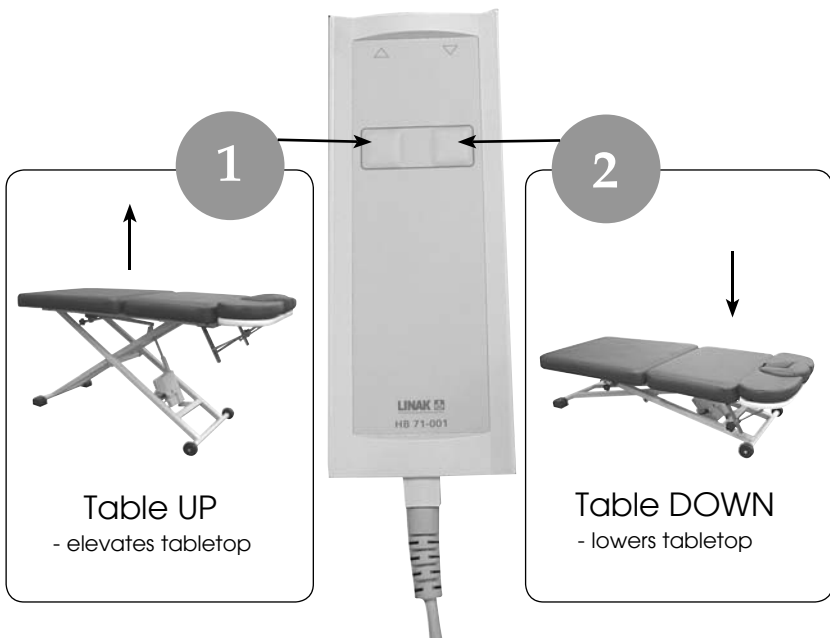

DIRECTIONS FOR USE

ADJUSTING THE BACKREST:

The backrest is adjusted manually. The release handles are found on the frame of the table just below the backrest on both sides of the table. They work in tandem and can be accessed on either side of the table.



IMPORTANT

Be sure to read all cautions, warnings and instructions given in the manual to prevent injury to both operator and client.

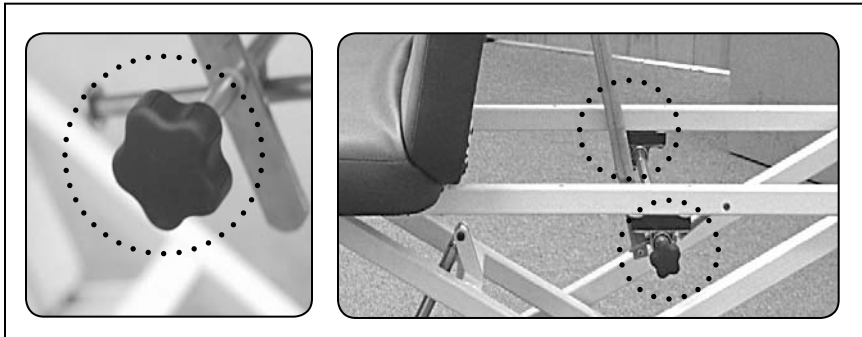

To Raise or Adjust the Angle of the Back Rest:

To raise the backrest from a flat position, grasp the back rest firmly and push (or pull) upwards until you have it at the angle you want. The backrest will automatically lock into this position when you release your hold. If you need to adjust the angle up, merely repeat the action until the top is in the desired position.

To adjust the position downwards, be sure you have a firm hold on the backrest (it will be heavy), twist and hold one of the release knobs as you guide the backrest down being careful to maintain a firm hold on the table back as you lower it. Let go of the release handle when you have the backrest at the level you need and the top will lock automatically in position.

The backrest will raise up 80° and when lowered it lies flat. It can be positioned at any angle within that range.



CAUTION

DO NOT raise or lower the Back Rest while the client is in position on the table. When making these adjustments make certain the patient weight is removed before proceeding.



CAUTION

DO NOT lower the Back Rest without a firm hold on the back rest. To release the lock on the position without manually guiding the back rest into place could cause personal injury or damage the table.



- Adjusting the Articulating Head Rest

DIRECTIONS FOR USE



CAUTION

DO NOT sit on the Head Rest Section.

DO NOT place excess weight on the Head Rest Section.

DO NOT use it in assisting the client on and/or off the table.

DO NOT lower the Articulating Head Rest while the client is in position on the table. When making these adjustments make certain the client is removed before proceeding.

DO NOT Lower the Head Rest without a firm hold on the top. To release the lock on the position without manually guiding the top into place could cause personal injury or damage to the table.

IMPORTANT

Be sure self-locking molded rubber feet are flat side down to ensure safety and stability.



ADJUSTING THE ARTICULATING HEAD REST (PT200, PT300 & ORTHOPEDIC HI-LO CASTING TABLE)

To Adjust the Angle of the Articulating Head Rest:

Certain models in the PT Line come with an Articulating Head Rest Section that has an adjustment range of 40° to -90° for prone positioning and the administering of special treatment techniques. The adjustments to this section are manual. To raise the Head Rest Section, just grasp the edge of the section and lift up until you have achieved the angle needed. Release and it will lock into place automatically.

When lowering the Head Rest Section, you need to unlock the positioning mechanism. On the PT200 the release mechanism is a lever; on the PT300 and the Orthopedic Hi-Lo Casting Table the mechanism is a knob. They are found under the Head Section on both sides of the table. They work in tandem and can be accessed on either side of the table. Be sure you have a firm grip on the edge of the Head Rest Section. Then twist and hold (be prepared for a slight drop as the lock mechanism releases) while guiding the section to the level desired. DO NOT make these adjustments with the client on the table.

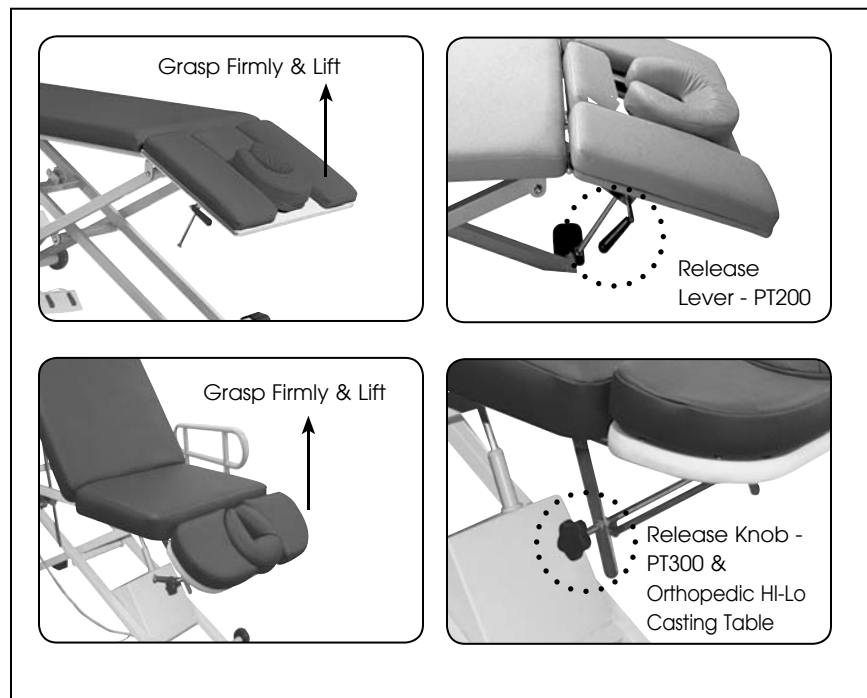

DIRECTIONS FOR USE

USE OF THE ARTICULATING HEAD REST SECTION (PT200, PT300)

The Articulating Head Rest is designed to give comfort and support for various techniques in both prone and supine positioning. The benefits of either of these positions can be accentuated with adjustments to the angle of the Head Rest Section as well as in the placement of the pads.

CAUTION

DO NOT sit on the Head Rest Section.

DO NOT place excess weight on the Head Rest Section.

DO NOT use it in assisting the client on and/or off the table.

DO NOT lower the Articulating Head Rest while the client is in position on the table. When making these adjustments make certain the client is removed before proceeding.

DO NOT Lower the Head Rest without a firm hold on the top. To release the lock on the position without manually guiding the top into place could cause personal injury or damage to the table.

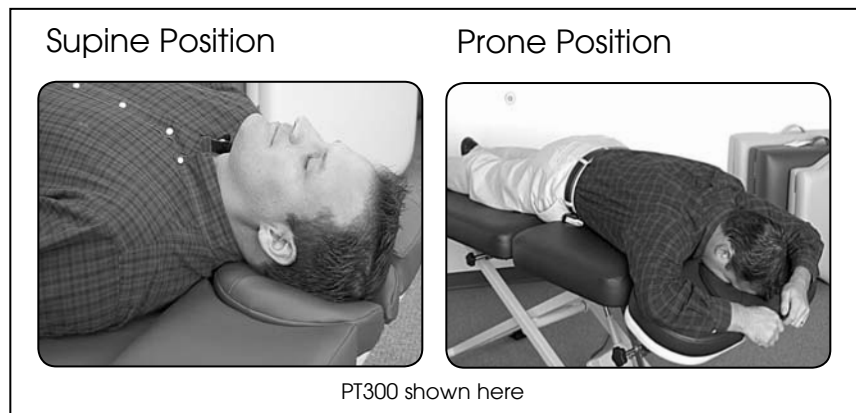

Proper Placement of the Head Rest Pads for Supine Positioning:

For techniques requiring a prone position, remove the face pad and place it with the ends pointing out from the table (as shown below). This will be a snug fit between the side pads, but press the ends together to put them into the space. Placing the face pad in this position provides a lifted area of padding support right at the neck area and gives the head a slight angle downwards that is both comfortable and easy on the client.

IMPORTANT

Be sure self-locking molded rubber feet are flat side down to ensure safety and stability.

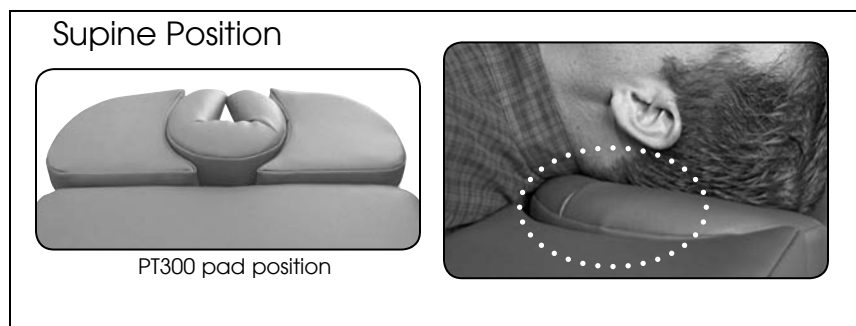

DIRECTIONS FOR USE

- Adjusting the Articulating Head Rest
- Adjusting the Siderail (PT300 & Orthopedic Hi-lo Casting Table only)

DIRECTIONS FOR USE

**CAUTION**

DO NOT sit on the Head Rest Section.

DO NOT place excess weight on the Head Rest Section.

DO NOT use it in assisting the client on and/or off the table.

DO NOT lower the Articulating Head Rest while the client is in position on the table. When making these adjustments make certain the client is removed before proceeding.

DO NOT Lower the Head Rest without a firm hold on the top. To release the lock on the position without manually guiding the top into place could cause personal injury or damage to the table.

USE OF THE ARTICULATING HEAD REST SECTION (PT200, PT300 & ORTHOPEDIC HI-LO CASTING TABLE)

Proper Placement of the Head Rest Pads for Prone Positioning:

For techniques requiring a prone position, place the face pad in the standard position as shown below. This provides support and comfort for the head and neck in any angle of articulation. And for extra stretch and contour to the back, the side pads on the Head Rest Section provide an ample area of support for the arms when in an overhead placement.

Prone Position



PT200 pad position



PT300 pad position



shown: PT300

ADJUSTING THE SECURITY SIDERAIL (PT300 & ORTHOPEDIC HI-LO CASTING TABLE OPTION)

The optional, retractable security rail provides safety during patient transfer and stability during procedures. It folds down easily for unobstructed patient access. Grasp the rail at the top and slide it towards the Head Rest Section until you feel the rail slip out of the notches in the frame. The rail can then be lowered to hang down slightly under the table and out of the way until needed again. Reverse the sequence to lift the rail back into an upright position.

IMPORTANT

Be sure self-locking molded rubber feet are flat side down to ensure safety and stability.

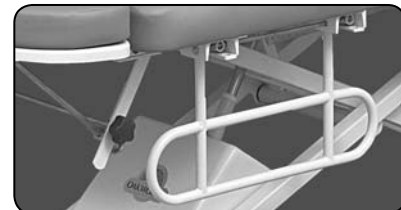
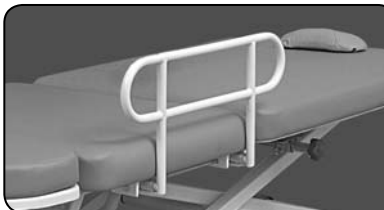

DIRECTIONS FOR USE

TO MOVE THE TABLE:

All models can be moved and set-up in different rooms thus ensuring that you expend your energy on the client, not the equipment.

The PT Series of tables are equipped with two wheels at one end and two self-locking, molded rubber feet at the other. When ready to move the table, first lower the table to its lowest position. On models with a backrest, it is recommended to raise the backrest to a high position. Then be sure the power source is disconnected. Place the cord out of the way on top of your table before moving the table.

Pick up all controls and lay them on the center of the table. Lay a towel or a cloth down on your table top to protect the surface from any debris from the bottom of your foot controls.

Two people are needed to safely move the table. Grasp the table at the brace between the molded rubber feet at that end of the table. By grasping the table frame firmly at this point, you can raise the table to allow the wheels at the foot end to move freely. Use proper positioning when raising the table by bending at the knees before lifting. This prevents back strain or possible injury.



WARNING

Before moving any of the PT Tables, disconnect the power cord from the power outlet.



CAUTION

The table weighs as much as 175 lbs. Use extreme caution when lifting the table to move it. Two people are needed to move the table safely. Be sure to bend from the knees to prevent back strain and possible injury.

DO NOT move the table with client still on the table.

IMPORTANT

Be sure to grasp the frame at the brace between the two legs of the frame on the end with the self-locking molded rubber feet to allow the wheels to move.

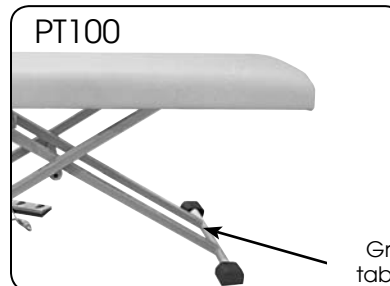

PT100

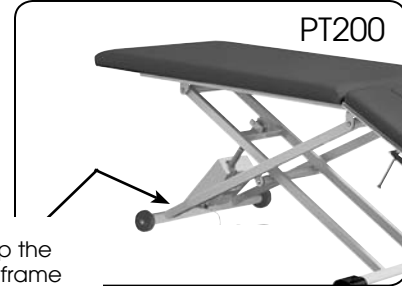

PT200

Grasp the table frame securely here at both sides of the brace.



PT300

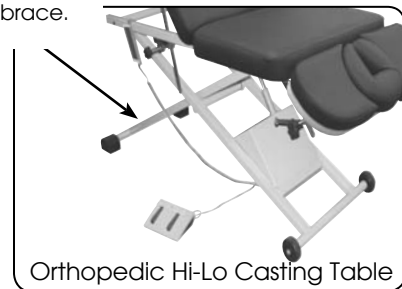

Orthopedic Hi-Lo Casting Table

Move the table carefully to the next location, lower the table and release. Check the self-locking molded rubber feet to be sure they are flat side down. This position "locks" the table and allows sturdy height adjustments. Place the foot controls in position on the floor. Connect the power cord to the outlet and test the foot controls.

DIRECTIONS FOR USE

QUICKLOCK™ FACE REST: (OPTIONAL ON PT100)

* U.S. Patent #5,177,823

Double articulating action provides nearly limitless positioning options with the QuickLock™ Face Rest. The adjustable pad takes pressure off sensitive facial areas while providing superb support. The QuickLock™ Face Rest can be used in both prone and supine positioning and folds out of the way when not in use or can be removed completely and stored. Adjustments are made easily by loosening the cam locks, adjusting for height and angle and then locking the cam locks into that position.



CAUTION

Do Not extend the dowels of the Face Rest further than 3" from the table edge to ensure a stable connection.



ATTACHING THE QUICKLOCK™ FACE REST:

PT100 Model only:

When attaching the QuickLock™ Face Rest, just slide the frame dowels into the outlets found at either end of the table, being sure to keep the 1st cam lock within 3" of the table to ensure a stable connection.

To remove the QuickLock™ Face Rest, just pull the frame from the outlets until it comes free. Set it safely aside.



CAUTION

Do not put excessive weight or pressure on the face rest.

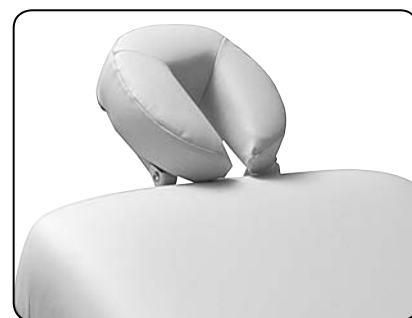
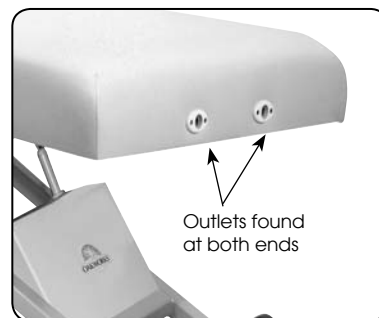

DIRECTIONS FOR USE

QUICKLOCK™ FACE REST (CONTINUED): * U.S. Patent #5,177,823

ATTACHING THE QUICKLOCK™ FACE REST: (cont)

PT300 & Orthopedic Hi-0Lo Casting Table Models only:

When attaching the QuickLock™ Face Rest, slide the frame dowels into the webbing loops found at the backrest end of the table, being sure to keep the 1st cam lock within 3" of the table to ensure a stable connection. The recommended length of dowel bracing against the backrest should be at least 2 inches.



IMPORTANT

Be sure to read all cautions, warnings and instructions given in the manual to prevent injury to both operator and client.



CAUTION

Do Not extend the dowels of the Face Rest further than 3" from the table edge to ensure a stable connection.



CAUTION

Do not put excessive weight or pressure on the face rest.

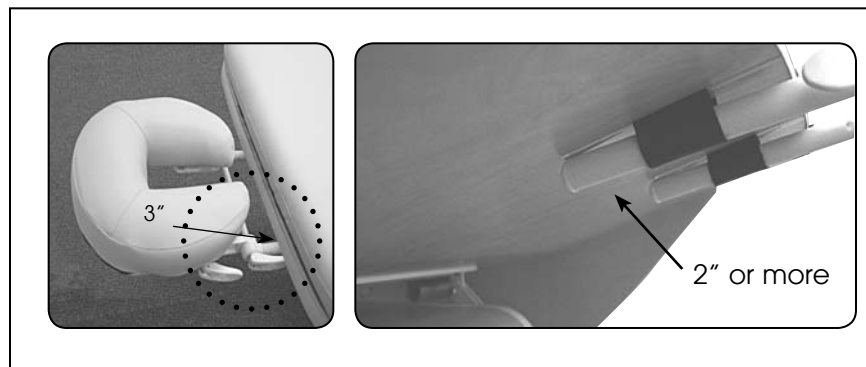
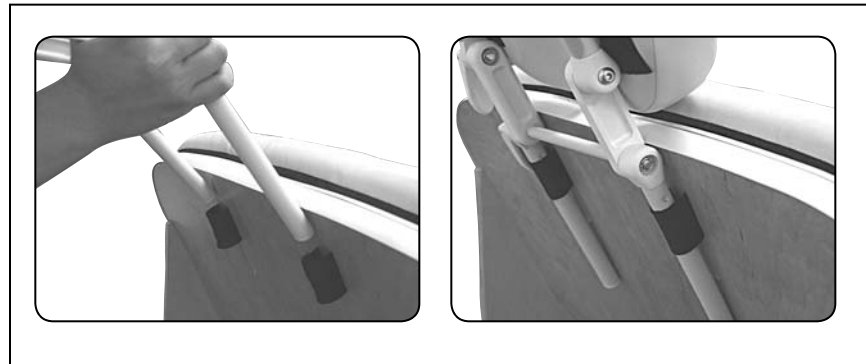

To remove the QuickLock™ Face Rest, just pull the frame from the outlets until it comes free. Set it safely aside.

Tips for Great Positioning using the QuickLock™ Face Rest:

- To use the face rest with your clients supine, rotate the face rest pad so that the thick part of the pad supports your client's cervical region. Adjusting the height and angle of the face rest gives your clients perfectly comfortable support. (see images on next page)

DIRECTIONS FOR USE

QUICKLOCK™ FACE REST (CONTINUED):



CAUTION

Do Not extend the dowels of the Face Rest further than 3" from the table edge to ensure a stable connection.



CAUTION

Do not put excessive weight or pressure on the face rest.

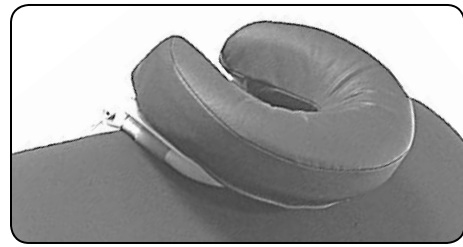

- The face pad is flexible so that you can bring the open ends together or spread them apart to achieve the most comfortable support for any size face. To avoid your client's chin from hitting the spacebar, make sure the pad is narrow enough to support their whole face.

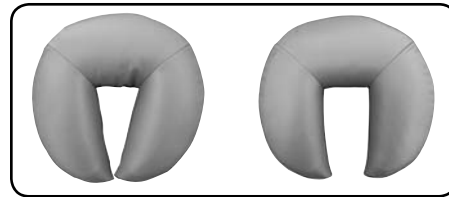

- For appropriate cervical flexion, use the cam locks to adjust the downward angle of the face rest, making sure that the surface of the face rest pad at the chin is not lower than the surface of the table.

CARE & CLEANING

HOW TO CARE FOR YOUR UPHOLSTERY:

In order to maintain the quality and ensure the life of the table, here are some preventative steps that can be taken to protect the upholstery on the chair and accessories.



DANGER

Before cleaning with any liquid cleaner, be sure to disconnect the power cord from the power outlet.

- Protect your table and accessories with sheets and fleeces. We offer both fitted sheets and thick fleeces that protect your upholstery fabric against oil stains while offering comfortable 100% cotton flannel softness to your clients. You can also preserve your face rest and bolsters with 100% cotton flannel covers and fleeces.
- Use only a mild solution of 4:1 diluted non-alcohol cleaner such as 409[®], Fantastik[®] or some other non-abrasive cleaner. A diluted 1/100 bleach solution for disinfecting can be used. Dry the table immediately after cleaning to remove excess cleaning solution. Using strong cleaners, such as alcohol, acetone, higher concentrations of bleach or other products that contain high concentrations of these substances, can shorten the life of your fabric, or discolor it. Note: Damage caused by these cleansers will not be covered under the warranty.
- Avoid extremes in temperature. Very cold temperatures can make your fabric prone to cracking. Very high temperatures can cause the fabric to stretch permanently.
- Avoid exposing your products to direct sunlight for extended periods of time. This can lead to fading and cracking of the fabric.
- Use an anti-slip pad to prevent oil from reaching the upholstery and to keep your sheets from slipping.

Caring for your table upholstery fabric involves more than just protecting it from general abrasions, cuts and punctures. We offer most of the products mentioned above.

- Base & Controls
 - Use only a mild solution of 4:1 diluted non-alcohol cleaner such as 409[®], Fantastik[®] or some other non-abrasive cleaner to wipe down the metal and wooden surfaces. Apply with a damp (not wet) lint-free cloth. Be sure excess liquid does not drip onto, or into, any of the electrical controls or mechanisms. Be sure that the unit is unplugged before cleaning these areas. Wipe these areas carefully with a lint free cloth.
 - The electronic or manual powering mechanism of your table requires no general maintenance or lubrication.
 - If the table will be out of use for an extended period of time, the power cord should be unplugged from the receptacle. To prevent inadvertent damage to the plug or cord, the cable should be coiled and secured with a wire tie or rubber band.
- Accessories
 - The face rest and table extender should be removed when not in use. These items should be stored in a cool, dry place.



SPECIFICATIONS - ELECTRICAL COMPONENTS

PT100 Model No: PXRT

Designed for:	North America	Europe/United Kingdom	Japan/Korea
Voltage/Current Service Available	120 VAC/20 amp	220 VAC/10 amp	100 VAC/20 amp
Current Consumption	1.5 amps	.8 amps	1.8 amps
Output Frequency	60 hz	50 Hz	50 /60 Hz
Voltage Output	24 VDC		
Electric Shock Protection	Class I Equipment		
Table Top Applied Part	 Type B Applied Part		
Table Top IEC 529 Rating	IPX0		
Mode of Operation	Continuous Operation @10% Duty Cycle		

PT200 Model No: PXA3

Designed for:	North America	Europe/United Kingdom	Japan/Korea
Voltage/Current Service Available	120 VAC/20 amp	220 VAC/10 amp	100 VAC/20 amp
Current Consumption	1.5 amps	.8 amps	1.8 amps
Output Frequency	60 hz	50 Hz	50 /60 Hz
Voltage Output	24 VDC		
Electric Shock Protection	Class I Equipment		
Table Top Applied Part	 Type B Applied Part		
Table Top IEC 529 Rating	IPX0		
Mode of Operation	Continuous Operation @10% Duty Cycle		

Storage & Transport	 Temperature: 32° - 100° F 0°-38° C	Humidity: 60% relative humidity During transport, DO NOT stack containers. 	Pressure: no limitations known
---------------------	--	---	--------------------------------

SPECIFICATIONS - ELECTRICAL COMPONENTS

PT300 Model No: PXAB30

Designed for:	North America	Europe/United Kingdom	Japan/Korea
Voltage/Current Service Available	120 VAC/20 amp	220 VAC/10 amp	100 VAC/20 amp
Current Consumption	1.5 amps	.8 amps	1.8 amps
Output Frequency	60 hz	50 Hz	50 /60 Hz
Voltage Output	24 VDC		
Electric Shock Protection	Class I Equipment		
Table Top Applied Part	 Type B Applied Part		
Table Top IEC 529 Rating	IPX0		
Mode of Operation	Continuous Operation @10% Duty Cycle		

Orthopedic Hi-Lo Casting Table Model No: PXAB30SROC

Designed for:	North America	Europe/United Kingdom	Japan/Korea
Voltage/Current Service Available	120 VAC/20 amp	220 VAC/10 amp	100 VAC/20 amp
Current Consumption	1.5 amps	.8 amps	1.8 amps
Output Frequency	60 hz	50 Hz	50 /60 Hz
Voltage Output	24 VDC		
Electric Shock Protection	Class I Equipment		
Table Top Applied Part	 Type B Applied Part		
Table Top IEC 529 Rating	IPX0		
Mode of Operation	Continuous Operation @10% Duty Cycle		

PRODUCT IDENTIFICATION

POWER LEAD PLUGS

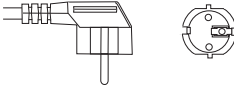
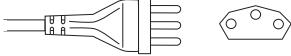
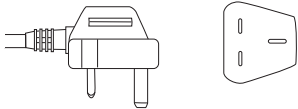
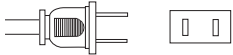
	Voltage (AC)	Power Cord Plug
	120v 60 Hz	3 prong grounded hospital grade; North America
	220v 50 Hz	Continental Plug; Europe
	220v 50 Hz	Swiss plug; Switzerland
	220v 50 Hz	British plug; United Kingdom
	100v 50/60 Hz	2 prong polarized plug;

WARRANTY STATEMENT

ALL PT MODELS

For full warranty details, please visit www.oakworks.com

All warranties are limited to factory-provided replacement parts, factory repair or replacement, at the discretion of OAKWORKS®.

All warranties exclude damage caused by improper set-up, accident, abuse, misuse, neglect, use for other than intended purpose or reasonable wear such as tears in the upholstery.

All warranties are invalidated by non-factory modifications and unauthorized repairs, which will immediately terminate all liability by OAKWORKS® for the product or damages caused by its use.

The buyer and its customers shall be responsible for proper set-up and use of the products as well as any supervision required for safety. In no event shall OAKWORKS® be liable for any special, indirect, consequential, incidental, exemplary or punitive damages or costs. Use of non-approved cleaning solutions voids the guarantee on all fabrics.

The warranties set forth herein are the sole and exclusive warranties provided by OAKWORKS®. There are no other warranties, representations or guarantees provided by OAKWORKS® either expressed or implied, including warranties of merchantability and fitness for a particular purpose.

Warranty valid with proof of purchase.