

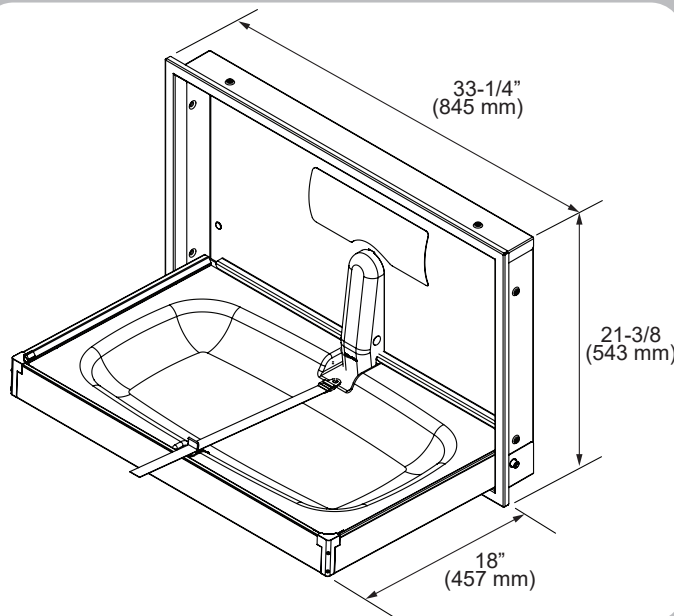

BABY CHANGERS MADE BY BABY EXPERTS.™

Submittal Sheet

Model 100SS-R Horizontal Stainless Steel Diaper Changing Station



- Full body 16 gauge, 304 brushed stainless steel.
- ABS replaceable tray liner.
- Smooth nylon belt with Thermoplastic Polyurethane coating. Easy to sanitize and adjustable with one hand.
- Full stainless steel frame and hinges provide maximum durability.
- Easy to read ANSI compliant labels (ANSI Z535.3 and ANSI Z535.4), utilizing universal safety symbols.
- Includes universal changing station door sign.
- Pneumatic gas shock mechanism to ensure smooth, safe open and close motions.
- Universal changing station plaque on front of unit.
- Limited Warranty: This product is warranted against manufacturing defects for a period of 5 years.

Short Specifications

Full 304 brushed stainless steel exterior with vacuum formed ABS changing surface.

1. A.D.A Compliant attached buckle.
2. Acceptable product: Foundations Worldwide, Inc.; Model 100SS-R (Horizontal Recessed Mount).
3. Characteristics:
 - a. Entire body 16 gauge, 304 brushed stainless steel, seamless welds.
 - b. Provide Foundations Worldwide, Inc. SS-Flange in order to surface mount unit.
 - c. Provide Foundations Worldwide, Inc. 200-SSLD; stainless steel liner dispenser.
4. Equipped with a pneumatic cylinder.
5. Smooth nylon belt with Thermoplastic Polyurethane coating. Easy to sanitize and adjustable with one hand.
6. Meets ASTM F2285 requirements for weight bearing Commercial Changing Stations.
7. **A.D.A. Compliance:**

	306.3 Knee Clearance
	307.2 Maximum Protruding Objects
	308.2 Forward Reach
	308.3 Side Reach
	309.4 Operation
	902.3 Work Surface
	Compliant when properly installed.
8. ANSI compliant safety labels.
9. CPSIA compliant to applicable sections.

Recommended Blocking Recessed Mount

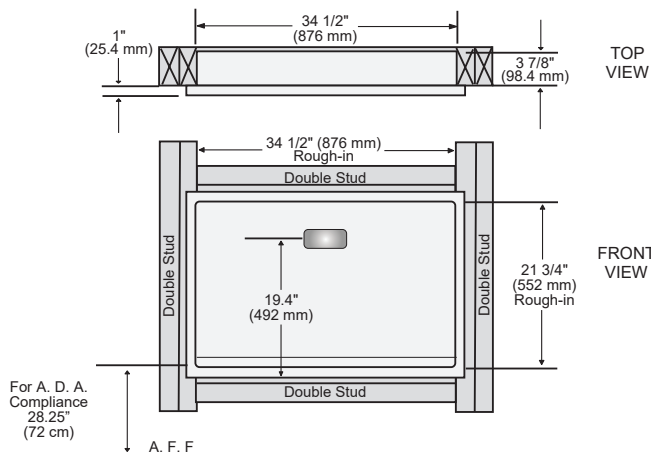

Installation Information

- 3.88 inches (98 mm) recessed into wall, 1 inch (25 mm) protrusion from wall.
- Rough-in opening 34.50 inches (876 mm) wide x 21.75 inches (552 mm) high. Shim as required for tight fit on all 4 sides. For recess mount, use side mounting holes.
- Open unit project from wall 18 inches (457 mm).