

**CHAIR INFORMATION**  
**RAZOR BLADE all terrain HCPC K0005**  
**Fixed FSH-RSH**  
**Max. Capacity 250Lbs**  
**Main Frame : ZK55 & ZK60 High Grade A7000 Series Aluminum**  
**NOTE**  
**Main Frame : Lifetime Warranty(5 YEARS)**  
 \*See warranty policy

**RehabMart.com**  
 Tools for the job of living  
 Quotes@RehabMart.com  
 1-800-827-8283  
 3651 Mars Hill Rd, Bldg 2400  
 Watkinsville, GA 30677-6042  
 USA

**A FRAME COLORS & PARTS COLORS**

<input type="checkbox"/> Neon Red	<input type="checkbox"/> Neon Yellow	<input type="checkbox"/> Brass Metallic	<input type="checkbox"/> Tiffany Blue	<input type="checkbox"/> Shocker Yellow	<input type="checkbox"/> Sparkle Burgundy	
<b>Powder-Coated</b>	<input type="checkbox"/> Gloss Black	<input type="checkbox"/> Twilight Flake	<input type="checkbox"/> Yellow	<input type="checkbox"/> Magenta	<input type="checkbox"/> Fire Engine Red	<input type="checkbox"/> White
	<input type="checkbox"/> Candy Blue	<input type="checkbox"/> Candy Purple	<input type="checkbox"/> Candy Green	<input type="checkbox"/> Candy Red	<input type="checkbox"/> Candy Raspberry	<input type="checkbox"/> Cobalt Blue
	<input type="checkbox"/> Matte Gray	<input type="checkbox"/> Matte Purple	<input type="checkbox"/> Matte Blue	<input type="checkbox"/> Matte Green	<input type="checkbox"/> Matte Black	<input type="checkbox"/> Matte Red
	<input type="checkbox"/> Neon Green	<input type="checkbox"/> Mellon Yellow	<input type="checkbox"/> Gun Smoke Silver	<input type="checkbox"/> Blue Lilac	<input type="checkbox"/> Reed Green	
	<input type="checkbox"/> Granny Sparkle Green	<input type="checkbox"/> Sparkle Sky Blue				
<b>Special</b>	<input type="checkbox"/> Polished					
<b>Please see Section C</b>						
<b>STD Color</b>	Black Color (*Suspension Springs-Silver Color Only . . . . .)					
<b>Custom Color Main Bolt on Parts One Color Package</b>	<input type="checkbox"/> Powder-Coated ( . . . . . ) . . . . . <input type="checkbox"/> Polished . . . . . <input type="checkbox"/> 24 karat Gold . . . . .					
Including: Backrest, Foot Plate, Footrest Rings, Backrest Brackets, Saddle Stops, Forks & Knurl Nuts, Caps, Front Suspension Springs ,						

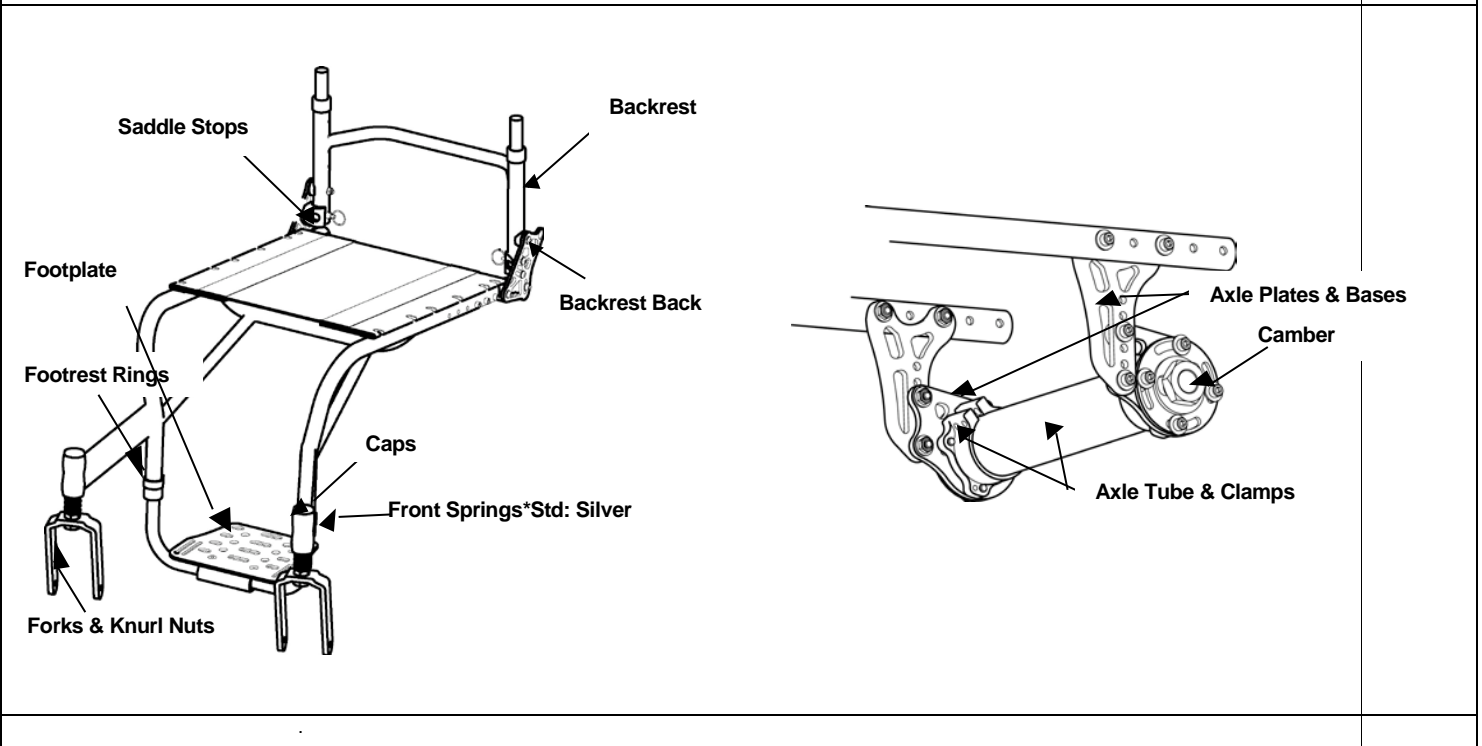

Caster Size	D (Approximately)
3" Caster	1.5"
4" Caster	2.0"
5" Caster	3.0"
8" Air Caster	5.5"

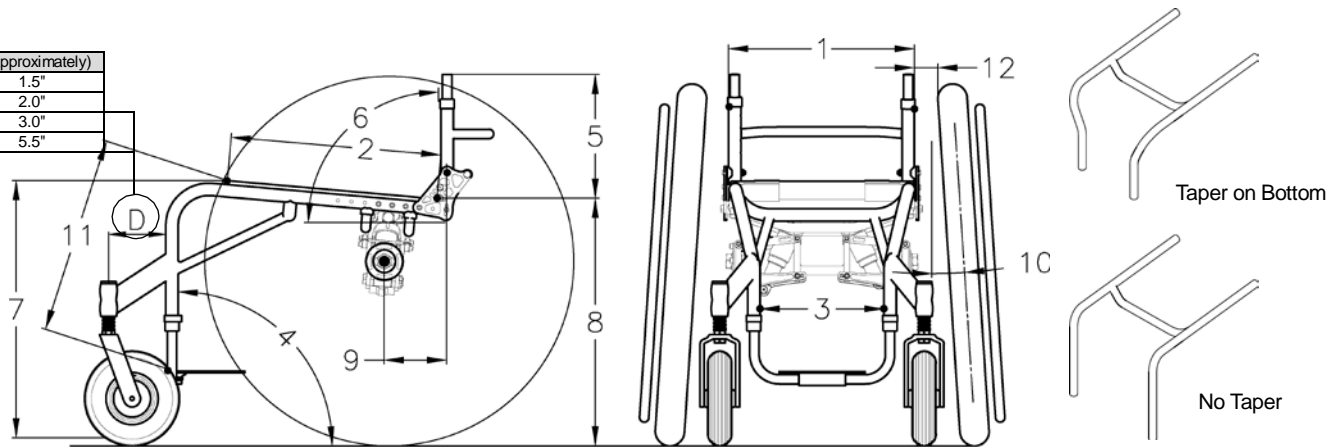

**1. SEAT WIDTH**     13"     14"     15"     16"     17"     18"     19" . . . . .

**2. SEAT DEPTH**  
 \* Only Choose One Option

**Net Seat Depth**     13"     14"     15"     16"     17"     18"     19" . . .  
 20" . . . . . **E2203**

**Depth Adj. Frame**     **Short Frame** (16" Depth) Set at  13"     14"     15"     16" . . .  
 **Long Frame** (19" Depth) Set at  16"     17"     18"     19"

**Aluminum Seat Pan**

**Positioning Frame** Add (    " ) . . . . .

**Ergo Seat Tubing Depth** (    " ) . . . . .

\*Measurement must be 2.5" longer than your Center of Gravity

**3. FOOTREST WIDTH**

**STD** (Seat Width Minus 5")     **Taper on Bottom Frame only** . . . . .

**Custom** (    " )     **Taper on Bottom Frame only** . . . . .

**No Taper** (Seat Width Minus 2") . . . . .

**FOOT PLATE STYLE**

**Standard single loop** with adjust. height & angle. STD Foot Plate . . . . .

**Single Flip-Back-single loop** (no riser avail) with adjust. height & angle. STD Foot Plate . . . **K0040**

STD Foot Plate Size Chart

Your Footrest Width	Foot Plate Size
8.5"-10.0"	W6.5"xD5"
10.5"-13.0"	W8.5"xD6.5"
13.5"-17.0"	W11"xD6.5"

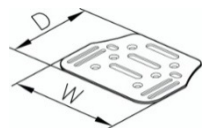

**CUSTOM FOOT PLATE**

**Custom Foot Plate.** with adjust. height & angle . . . . . (    " )

\*Available Solid Plate Only

\*Measurement must be 2.5" shorter than your Footrest Width

**Custom Tubular Footrest** . . . . . (    " )

\*Measurement must be 2.5" shorter than your Footrest Width

**With ABS Foot Plate (\$75 up charge)**

**4. FRAME ANGLE**

75°     80°     85°     90° to the ground . . . . .

**Custom** (    ° ) to the ground . . . . .

**5. BACKREST HEIGHT** 8" 9" 10" 11" 12" 13" 14" 15" 16" 17" 18"  
 \* Rigidizer bar 3.25" deep std.

**TYPE**  Locking mechan. with adjust. height & angle  
 Double Locking mechan. with adjust. height & angle  
 Folding with adjust. height & angle

**CUSTOM**  Welded Backrest Angle Set at ( ) to the ground \*Non Folding Backrest  
 Welded Side Guards \*w / Welded Backrest only

Custom Backrest  
 (ie: double rigidizer bars, custom depth, custom height, etc)

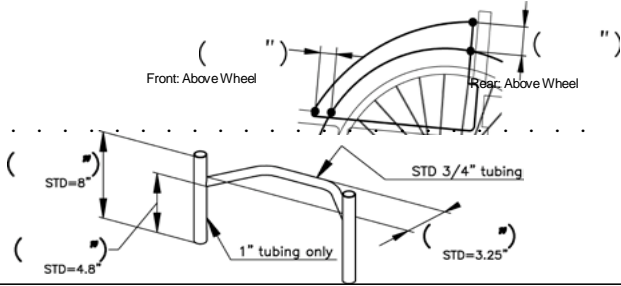

**6. BACKREST ANGLE** Set at ( ) to the ground \*STD 90°

**7. FRONT SEAT HEIGHT** 17.0" 17.5" 18.0" 18.5" 19.0"  
19.5" 20.0" 20.5" 21.0"

Front Seat Height Ranges

Caster Wheel Size	Front Seat Height
3" Caster	17.0" - 19.5"
4" Caster	17.0" - 20.0"
5" Caster	17.0" - 21.0"
8" Air Caster	18.0" - 21.0"

**8. REAR SEAT HEIGHT** 14.5" 15.0" 15.5" Not Available w / Air Ride System  
16.0" 16.5" 17.0" 17.5" 18.0" 18.5" 19.0" 19.5"  
 \*The rear seat heights are impacted by the size of your rear tire.

w/ Colours Air Ride System Rear Seat Height Option  
 \*Including ;Fox Racing Shox 300 HP Pump

Black Color  
 Powder-Coated ( ) (\$380 up charge)  
 Polished Aluminum (\$920 up charge)

OMIT AIR PRO KIT = \$350 help shocks better perform

STD Rear Seat Height Ranges	
Rear Tire Size	Rear Seat Height
24"x1"(540)	14.5"- 18.0"
24"x1 3/8"(540)	15.0"- 18.0"
25"x1"(559)	15.5"- 18.0"
24"x2"(540)	15.5"- 18.5"
26"x1"(590)	15.5"- 19.0"
25"x1.95"(559)	16.0"- 19.0"

\*No Custom Modifications

Rear Seat Height Ranges w/ Air Ride System	
Rear Tire Size	Rear Seat Height
24"x1"(540)	16.0"- 18.5"
24"x1 3/8"(540)	16.5"- 19.0"
25"x1"(559)	16.5"- 19.0"
24"x2"(540)	17.0"- 19.5"
26"x1"(590)	17.0"- 19.5"
25"x1.95"(559)	17.5"- 19.5"

\*No Custom Modifications

**REAR SUSPENSION RATING**

- Set up 50psi (For 80 lbs-110 lbs weight)
- Set up 60psi (For 110 lbs-140 lbs weight)
- Set up 80psi (For 140 lbs-170 lbs weight)
- Set up 100psi (For 170 lbs-200 lbs weight)
- Set up 120psi (For 200 lbs-230 lbs weight)
- Set up 150psi (For 230 lbs-250 lbs weight)

**9. CENTER OF GRAVITY** 1.5" 2.0" 2.5" 3.0" 3.5"  
4.0" 4.5" 5.5" 6.0" \*Not Available w / Net Seat Depth Frame

**10. CAMBER ANGLE** 2° 4° 6°

**11. FRONT OF SEAT SLING TO FRONT OF FOOTREST** 15.0" 15.5" 16.0" 16.5" 17.0" 17.5" 18.0" 18.5" 19.0" 19.5"  
 \*Not Available w / 19.0", 19.5", 20.0", 20.5", 21.0" Front Seat Height  
 \*Measurement must be 1.5" shorter than your Front Seat Height

**HIGH MOUNT** 11.0" 11.5" 12.0" 12.5" 13.0" 13.5" 14.0" 14.5" 15.0" 15.5" 16.0"  
 With Risers or Clamps

**12. INSIDE WHEEL CLEARANCE** 3/4" 1" 1 1/4" 1 1/2" 1 3/4" 2"  
 \*3/4" Inside wheel clearance not available with 2 degree camber. (with the exception of Y-360 wheels)  
 \*3/4" Inside wheel clearance not available with Armrest \*3/4" Inside wheel clearance not available with Bite Hub Locks

## 1. SEAT WIDTH

Measure from outside of seat tube to the outside of the opposite seat tube.

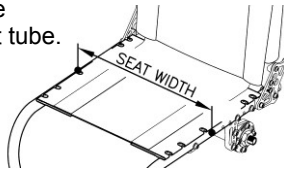

## 2. SEAT DEPTH

Measure from at the front bottom of backrest tube to the front edge of seat sling.

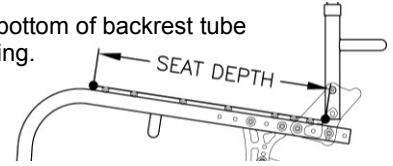

## 3. FOOTREST WIDTH

Measure from inside of front frame tube to inside of opposite front frame tube.

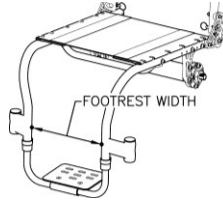

## 4. FRAME ANGLE

Measure angle frame front to floor.

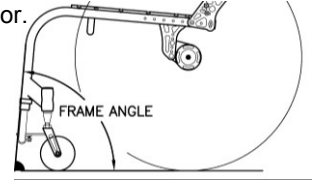

## 5. BACKREST HEIGHT

Measure from top of back post to seat sling at front bottom of backrest tube.

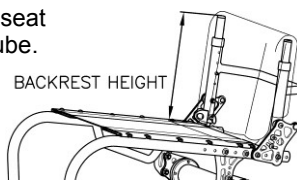

## 6. BACKREST ANGLE

Measure angle from front of back post to floor.

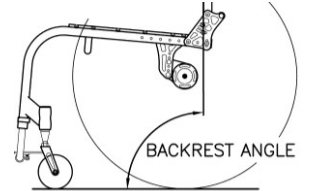

## 7. FRONT SEAT HEIGHT

Measure from floor to top of seat sling at front edge.

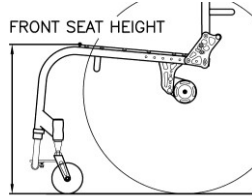

## 8. REAR SEAT HEIGHT

Measure from floor to top of seat sling at front bottom of backrest tube.

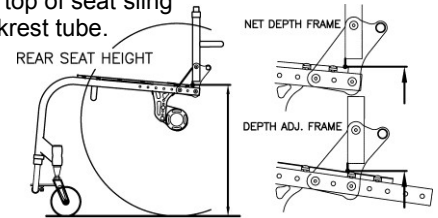

## 9. CENTER OF GRAVITY

Measure from center of back tube at the folding pivot to the center of the rear axle.

( If welding backrest is selected, Measure from center of back tube at the seat tube to the center of the rear axle. )

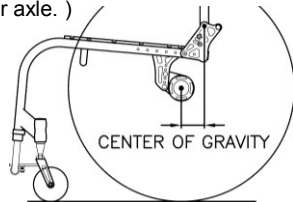

## 10. CAMBER ANGLE

Measure angle from wheel to vertical at floor.

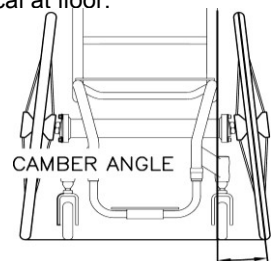

## 11. FRONT OF SEAT SLING TO FOOTREST

### ADULT CHAIR

Measure from top of seat sling at front edge to top of foot plate at front edge.

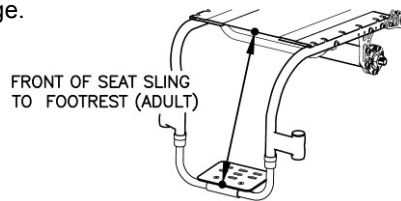

### PEDIATRIC CHAIR

Measure vertical from top of seat sling at front edge to top of foot plate.

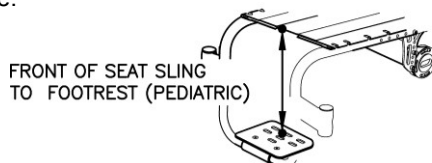

## 12. INSIDE WHEEL CLEARANCE

Measure from outside of seat back tube to inside of rear tire.

( If side guards are selected, measure from outside of side guards to inside of rear tire.)

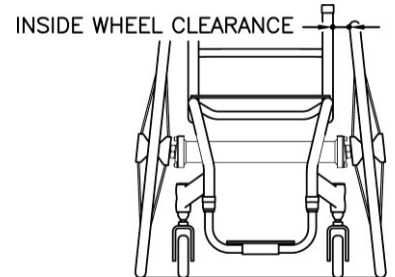

**C SPECIAL PARTS COLORS ( Please allow an additional 1-2 weeks delivery)**

PARTS COLORS	Neon Yellow	Brass Metallic	Sparkle Burgundy	Tiffany Blue	Shocker Yellow	
<b>Powder-Coated</b>	Gloss Black	Twilight Flake	Yellow	Magenta	Fire Engine Red	White
	Candy Blue	Candy Purple	Candy Green	Candy Red	Candy Raspberry	Cobalt Blue
	Matte Gray	Matte Purple	Matte Blue	Matte Green	Matte Black	Matte Red
		Orange Sparkle	Mellon Yellow	Gun Smoke Silver		
	Granny Sparkle Green	Sparkle Sky Blue	Reed Green	Blue Lilac		

**Special Colors** Polished Aluminum  
 24 karat Gold Plated \*Please allow an additional 4 weeks delivery

**Please Choose the Color for each Part**

\*Parts not selected will be black color. (Suspension Spring: Silver Color)  
 \*Minimum 3 parts selected per order.

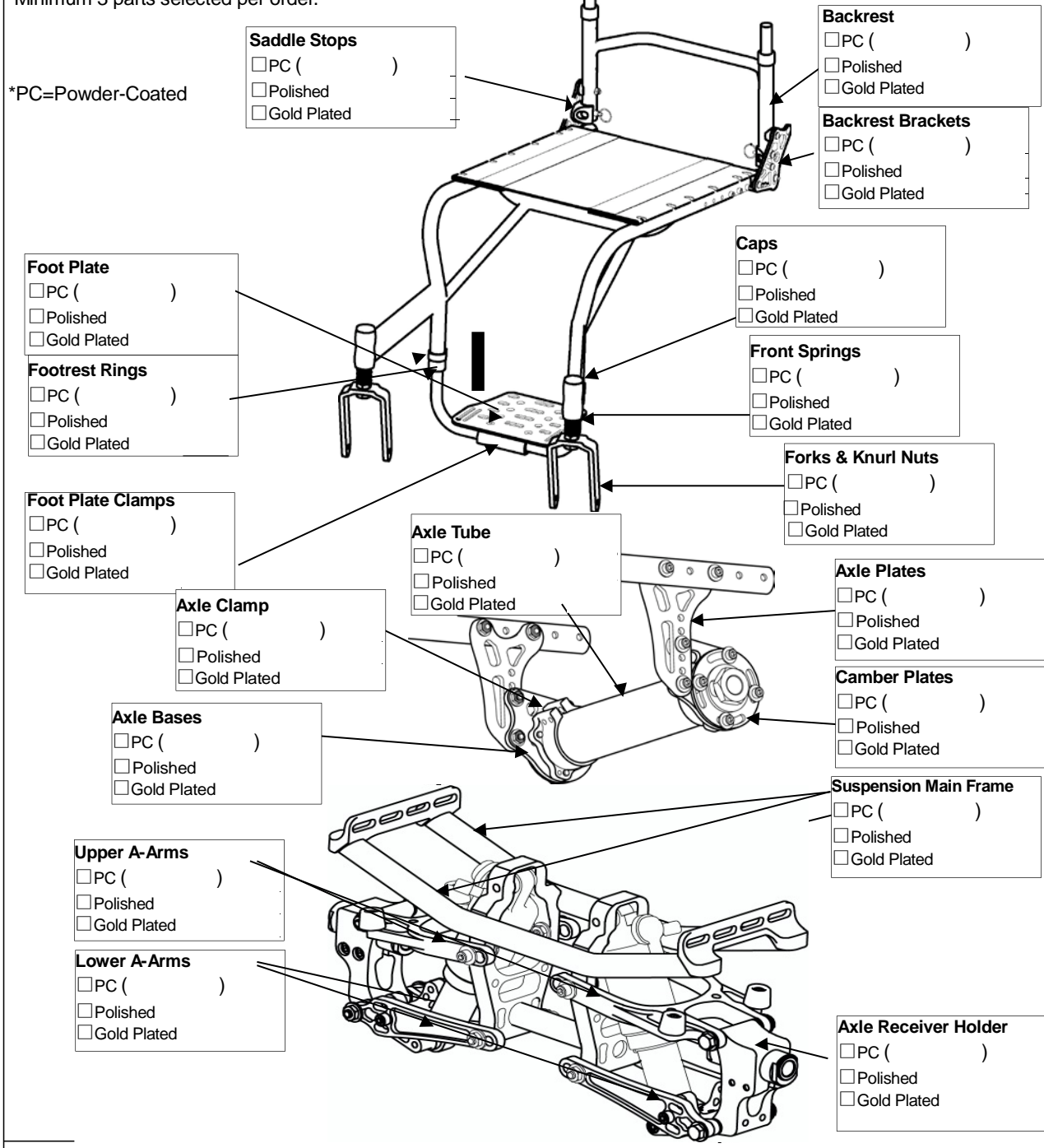

**D COMPONENTS**

**WHEEL LOCKS**

New Solutions Push to Lock  w/ 2" Extension Handle (\$80 up charge)

Gallop Push to Lock / Anodized

Question Mark Style Scissor

NEW Compact Scissor Lock / Anodized Black Only

Gallop Scissor Lock / Anodized

**PUSH HANDLES** \*If you are ordering push handles, You must select the backrest locking mechanism.

Integrated w/Fixed Backrest Height / Anodized Black Only

Bolt-on / Anodized Black Only Specify Height from floor -( )

Bolt-on w/Quick Release / Anodized Black Only Specify Height from floor -( )

NEW Height Adj. / Anodized Black Only Specify Maximum height from floor -( )

**NEW ARM RESTS** Anodized Black Only

Fixed Tubular Armrest Adj. Angle and Height Height from seat sling Set at : 8" 9" 10" 11" 12" **E0973**

Swing Away Tubular Armrest Adj. Angle and Height Height from seat sling Set at : 8" 9" 10" 11" 12" **E0973**

Flip-Up Armrest  w/Fixed Tubular Armrest Height from seat sling Set at : 8" 9" 10" 11" 12" **E0973**  
Adj. Angle  w/ Swing Away Tubular Armrest Height from seat sling Set at : 8" 9" 10" 11" 12" **E0973**

Custom Length & Height (\$150 up charge)  
\*Specify Height & Length →

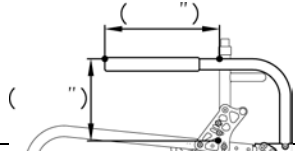

**ANTI-TIPPERS**

Removable Anti-tipper(pair) Anodized Black Only **E0971**

Press Release Removable Anti-tipper(pair) **E0971**

**SIDE GUARDS**

Rigid Side Guards - Black ABS  Non-Removable  Removable  Removable w/Hole (\$12 up charge)  
Color: Black Only Size:  STD  Medium  Cut to Wheel (\$98 up charge) Measurement

Rigid Side Guards - Aluminum  Non-Removable  Removable  
Size:  Medium Only  Cut to Wheel (\$98 up charge) Measurement  
Color  Black (STD)  Pol. Aluminum (STD)  
 Powder Coated ( ) (\$120 up charge)  
 Gold Plate (+CFP)

Fabric Clothing Guards Black Nylon w/Velcro

**SEAT CUSHION** -\*Please see section for other cushion choices.-

Foam Cushion w/Nylon Black Cover Thickness 1" 2" 3" 4"

Custom Cushion Cover (Std. Foam Cushion Only) -Select Fabric ( ) (\$90 up charge)

**ACCESSORIES**

Frame Protectors / Black Leather/Zipper Type

Gel Ovation Protector Wraps Gel Silicone

E0978 Seat Belt w/Auto Buckle (BP) 1.5" Black Belt Only **E0978**

Tie Down Brackets 4pcs.

Calf Strap  Black  Matching Fabric (\$55 up charge) -Select Fabric ( )

Bodypoint Padded Calf Strap  (14"-16" footrest width) \$77  (16"-20" footrest width) \$83  (20"-24" footrest width) \$89

Hanging Zipper Pouch  Black  Matching Fabric (\$60) or  Leather (\$75) Custom Size Width: Length:

Matching Fabric on Padded Side Guards -Select Fabric ( )

**UPHOLSTERY CHOICE & COLOR** \*Positioning Back Available. Please see Section E

Standard Adjustable Height Backrest (Black)

Adjustable Tension Backrest Black Only (\*Not available with 8" Backrest Height)

Options  Fun Fabric: For Std. or Adj. Style  
(Choose From Choices on Page 7 and write below) (\$ 80 up charge)

Backrest Leather Trim (outside panels) (\$ up charge)

FABRIC CHOICE SHEET

1. Camouflage Girls

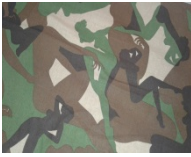

2. Purple Zebra



3. Silver Grey Snake

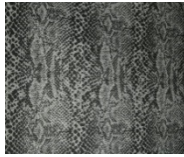

5. Laughing Skulls



6. Purple Snake



7. Sweetheart Pinup Girls



9. Blue Flames

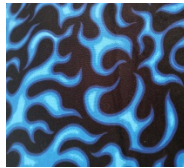

10. Arctic Camo



11. Furry Friends



12. Supercars



13. Urban Camo

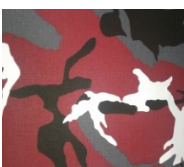

14. Superbikes



15. Sizzle Flames



16. Hot Rod Flames



17. Skulls w/ Attitude



18. Sweet Pink

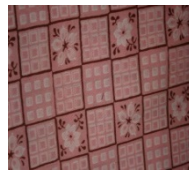

19. Heart and Soul



20. Home Run



21. Fuzzy Giraffe

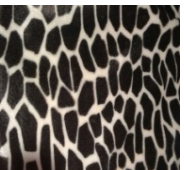

22. Cheetah



23. Paperweight Cobalt



24. Zig Zag Dots



25. Smokey Tribal Flames

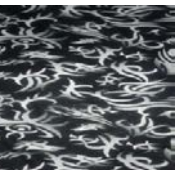

26. Rose and Rebellion



27. Tattoo Adventure(Cream

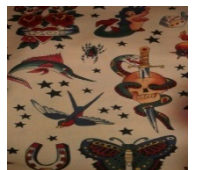

28. Red Tribal Flames

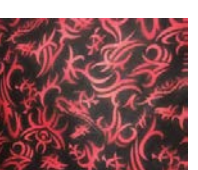

29. Tattoo Adventure(Black)

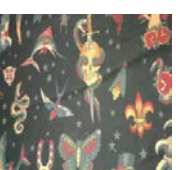

30. Butterfly Bandana

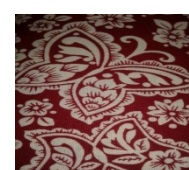

31. Tatsu Dragon

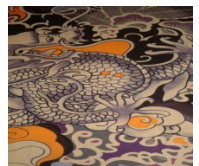

**E TIRES, CASTERS, & FORKS**



TIRES	
<input type="checkbox"/> <b>Primo High Pressure Tire</b> <input type="checkbox"/> 24"x1" <input type="checkbox"/> 25"x1" <input type="checkbox"/> 26"x1" Gray Tire w/ black line . . . . .	E2211/E2212
<input type="checkbox"/> <b>Primo High Pressure Tire</b> <input type="checkbox"/> 24"x1" <input type="checkbox"/> 25"x1" or <input type="checkbox"/> 26"x1" <input type="checkbox"/> Blue <input type="checkbox"/> Red . . . . .	E2211/E2212
<input type="checkbox"/> <b>Low Pressure Tire</b> <input type="checkbox"/> 24"x1-3/8" or <input type="checkbox"/> 26"x1-3/8" Gray Only . . . . .	E2211/E2212
<input type="checkbox"/> <b>Schwalbe Marathon Plus High Pressure Tire</b> <input type="checkbox"/> 24"x1", <input type="checkbox"/> 25"x1" or <input type="checkbox"/> 26"x1" Black Only . . . . .	E2211/E2212
<input type="checkbox"/> <b>Solid Tire</b> <input type="checkbox"/> 24"x1" <input type="checkbox"/> 25"x1" Black . . . . .	E2218
<input type="checkbox"/> <b>Solid Tire</b> <input type="checkbox"/> 26"x1" Dark Grey . . . . .	
<input type="checkbox"/> <b>Moderate V-Track Knobby Tire</b> 24"x1-3/8" (37-540) Gray Only . . . . .	E2211/E2212
<input type="checkbox"/> <b>Aggressive Knobby Tire</b> 24"x2" (50-540) Gray Only <input type="checkbox"/> Blue Line <input type="checkbox"/> Red Line . . . . .	E2211/E2212
<input type="checkbox"/> <b>Aggressive Knobby Tire</b> 26"x2" (50-559) Gray Only <input type="checkbox"/> Blue Line <input type="checkbox"/> Red Line . . . . .	E2211/E2212
<input type="checkbox"/> <b>Aggressive Knobby Tire</b> 24" x 1.95"(50-540) Black Only . . . . .	E2211/E2212
<input type="checkbox"/> <b>E2211 Bell Mountain Bike Tire</b> in Flat Defense (559) 26" X 1.75 - 2.25 Black Only . . . . .	E2211/E2212
<input type="checkbox"/> <b>Flat-Free Inserts</b> For 24"x1-3/8" Tires Only . . . . .	E2211/E2213

CASTERS				
SIZE	TIRE WIDTH	HUB COLOR	TIRE COLOR	DESCRIPTION
<input type="checkbox"/> 3"	1"	Black Hub	Black Tire Only	Polyurethane <b>K0077</b>
<input type="checkbox"/> 3"	1"	Plastic Black Hub	Clear Tire Only	Lighted, Polyurethane <b>A9900</b>
<input type="checkbox"/> 3"	1"	Red Hub	Red Tire Only	Polyurethane <b>E2222</b>
<input type="checkbox"/> 3"	1"	Black Hub	Clear Tire Only	Polyurethane <b>E2222</b>
<input type="checkbox"/> 3"	1"	Aluminum Silver Hub	Black Tire Only	Made By Frog Legs <b>K0071</b>
<input type="checkbox"/> 3"	1"	Aluminum Black Hub	Black Tire Only	Made By Frog Legs <b>E2222</b>
<input type="checkbox"/> 3"	1.5"	Aluminum Silver Hub	Black Tire Only	Soft Roll Made By Frog Legs <b>E2222</b>
<input type="checkbox"/> 3"	1.5"	Aluminum Black Hub	Black Tire Only	Soft Roll Made By Frog Legs <b>E2222</b>
<input type="checkbox"/> 4"	1 1/8"	Plastic Black Hub	Black Tire Only	Polyurethane <b>E2222</b> Not Available with Narrow Frog Leg Forks
<input type="checkbox"/> 4"	1"	Plastic Black Hub	Clear Only	Lighted, Polyurethane <b>E2221</b>
<input type="checkbox"/> 4"	1"	Aluminum Silver Hub	Black Tire Only	Made By Frog Legs <b>E2214</b>
<input type="checkbox"/> 4"	1"	Aluminum Black Hub	Black Tire Only	Made By Frog Legs <b>E2214</b>
<input type="checkbox"/> 4"	1.5"	Aluminum Silver Hub	Tire <input type="checkbox"/> Black <input type="checkbox"/> Blue <input type="checkbox"/> Red	Soft Roll Made By Frog Legs <b>E1015</b>
<input type="checkbox"/> 4"	1.5"	Aluminum Black Hub	Black Tire Only	Soft Roll Made By Frog Legs <b>E2214</b>
<input type="checkbox"/> 5"	1"	Composite Black	Black Tire Only	Polyurethane <b>E2222</b>
<input type="checkbox"/> 5"	1"	Plastic Black Hub	Clear Tire Only	Lighted, Polyurethane <b>A9900</b>
<input type="checkbox"/> 5"	1"	Aluminum Silver Hub	Black Tire Only	Made By Frog Legs <b>A9900</b>
<input type="checkbox"/> 5"	1"	Aluminum Black Hub	Black Tire Only	Made By Frog Legs <b>E2214</b>
<input type="checkbox"/> 5"	1.5"	Aluminum Silver Hub	Tire <input type="checkbox"/> Black <input type="checkbox"/> Blue <input type="checkbox"/> Red	Soft Roll Made By Frog Legs <b>K0072</b>
<input type="checkbox"/> 5"	1.5"	Aluminum Black Hub	Black Tire Only	Soft Roll Made By Frog Legs <b>E2222</b>
<input type="checkbox"/> 6"	1.5"	Aluminum Black Hub	Black Tire Only	Soft Roll Made By Frog Legs <b>E2222</b>
<input type="checkbox"/> 6"	1.5"	Aluminum Silver Hub	Black Tire Only	Soft Roll Made By Frog Legs <b>E2222</b>
<input type="checkbox"/> 8"	1.5"	Composite Black Hub	Black Tire Only	8" Air Caster w/Monster Fork
<input type="checkbox"/> "	<input type="checkbox"/> 1"OR <input type="checkbox"/> 1.5"	Hub Color:	Tread Color:	Soft Roll Made By Frog Legs <b>E2222</b>

FORKS	
<input type="checkbox"/> <b>Frog Leg Shields(4 pcs) Only for Frog Leg Forks</b>	
<input type="checkbox"/> <b>STD Aluminum Forks</b> with Suspension . . . . .	
Springs Black Only	
Extra Options for Aluminum Forks <input type="checkbox"/> Without Suspension Springs . . . . .	E1015
<input type="checkbox"/> With Quick Release Axles . . . . .	K0073
<input type="checkbox"/> <b>Frog Leg Suspension Forks 1" Wide</b> (For 3", 4" x 1" width Caster and 5" STD Caster, 5" lighted Caster) . . . . .	Not available with Quick Release Axle
*User's Weight _____ Color <input type="checkbox"/> Anodized Black <input type="checkbox"/> Anodized Silver . . . . .	E1015
<input type="checkbox"/> <b>Frog Leg Suspension Forks 1.5" Wide</b> (For 3", 4" x 1.5" width Caster and 5" x 1" & 5" x 1.5" Casters ) . . . . .	Not available with Quick Release Axle
*User's Weight _____ Color <input type="checkbox"/> Anodized Black <input type="checkbox"/> Anodized Silver . . . . .	E1015



**F WHEELS**

<b>WHEELS</b>													
<b>Wire Wheels</b>	<input type="checkbox"/> 24" (540) <input type="checkbox"/> 25" (599) ..... <input type="checkbox"/> 26" (590)												
<b>Y-360 Billet Wheels</b> <small>*Max. Capacity 220Lbs *Camber 0-2" max</small> <small>*Not for Sports or Rugged use</small>	<input type="checkbox"/> 25" (559) ..... Style <input type="checkbox"/> Saw Blade												
<b>Y-360 Billet Wheels MOD Style</b> <small>*Max. Capacity 220Lbs *Camber 0-2" max</small> <small>*Not for Sports or Rugged use</small>	<input type="checkbox"/> 25" (559) Only Style <input type="checkbox"/> Tribal Sun <input type="checkbox"/> Girls <input type="checkbox"/> Eagle <input type="checkbox"/> Holy Cross <input type="checkbox"/> Hono(Flames) ..... Specify Powder Coat Color for Insert Only ( ) *Choose from Frame Colors												
<b>Extra Options for</b>  <input type="checkbox"/> Powder-Coated Spokes Only ( ) *Choose from Frame Colors <b>(\$250 up charge)</b>													
<b>Spinergy Spox 18 Spokes</b> 	<input type="checkbox"/> 24" (540) <input type="checkbox"/> 25" (559) <input type="checkbox"/> 26" (590) Spoke Color <input type="checkbox"/> Black With Silver Hub <input type="checkbox"/> Red With Black Hub <input type="checkbox"/> Yellow With Black Hub <input type="checkbox"/> Blue With Black Hub <input type="checkbox"/> White With Black Hub .....  <input type="checkbox"/> Custom Color Spoke Pattern <table border="1" style="display: inline-table; border-collapse: collapse;"> <tr> <td></td> <td>Left Wheel</td> <td>Right Wheel</td> </tr> <tr> <td>Spokes</td> <td>Inside</td> <td>.....</td> </tr> <tr> <td>Color</td> <td>Outside</td> <td></td> </tr> <tr> <td>Hub Color</td> <td><input type="checkbox"/> Black/<input type="checkbox"/> Silver</td> <td><input type="checkbox"/> Black/<input type="checkbox"/> Silver</td> </tr> </table>		Left Wheel	Right Wheel	Spokes	Inside	.....	Color	Outside		Hub Color	<input type="checkbox"/> Black/ <input type="checkbox"/> Silver	<input type="checkbox"/> Black/ <input type="checkbox"/> Silver
	Left Wheel	Right Wheel											
Spokes	Inside	.....											
Color	Outside												
Hub Color	<input type="checkbox"/> Black/ <input type="checkbox"/> Silver	<input type="checkbox"/> Black/ <input type="checkbox"/> Silver											
<b>Spinergy LX 12 Spokes</b> 	<input type="checkbox"/> 24" (540) <input type="checkbox"/> 25" (559) <input type="checkbox"/> 26" (590) Spoke Color <input type="checkbox"/> Black With Silver Hub <input type="checkbox"/> Red With Black Hub <input type="checkbox"/> Yellow With Black Hub <input type="checkbox"/> Blue With Black Hub <input type="checkbox"/> White With Black Hub <input type="checkbox"/> Neon Green With Black Hub <input type="checkbox"/> Pink With Black Hub <input type="checkbox"/> Orange With Black Hub <input type="checkbox"/> Purple With Black Hub  <input type="checkbox"/> Custom Color Spoke Pattern <table border="1" style="display: inline-table; border-collapse: collapse;"> <tr> <td></td> <td>Left Wheel</td> <td>Right Wheel</td> </tr> <tr> <td>Spokes</td> <td>Inside</td> <td></td> </tr> <tr> <td>Color</td> <td>Outside</td> <td></td> </tr> <tr> <td>Hub Color</td> <td><input type="checkbox"/> Black/<input type="checkbox"/> Silver</td> <td><input type="checkbox"/> Black/<input type="checkbox"/> Silver</td> </tr> </table>		Left Wheel	Right Wheel	Spokes	Inside		Color	Outside		Hub Color	<input type="checkbox"/> Black/ <input type="checkbox"/> Silver	<input type="checkbox"/> Black/ <input type="checkbox"/> Silver
	Left Wheel	Right Wheel											
Spokes	Inside												
Color	Outside												
Hub Color	<input type="checkbox"/> Black/ <input type="checkbox"/> Silver	<input type="checkbox"/> Black/ <input type="checkbox"/> Silver											
<b>Spinergy X-Laced Sport Lite Extreme "XSLX" 24 Spokes</b> 	<input type="checkbox"/> 24" (540) <input type="checkbox"/> 25" (559) <input type="checkbox"/> 26" (590) Spoke Color <input type="checkbox"/> Black With Silver Hub <input type="checkbox"/> Red With Black Hub <input type="checkbox"/> Yellow With Black Hub <input type="checkbox"/> Blue With Black Hub <input type="checkbox"/> White With Black Hub <input type="checkbox"/> Neon Green With Black Hub <input type="checkbox"/> Pink With Black Hub <input type="checkbox"/> Orange With Black Hub <input type="checkbox"/> Purple With Black Hub  <input type="checkbox"/> Custom Color Spoke Pattern <table border="1" style="display: inline-table; border-collapse: collapse;"> <tr> <td></td> <td>Left Wheel</td> <td>Right Wheel</td> </tr> <tr> <td>Spokes</td> <td>Inside</td> <td></td> </tr> <tr> <td>Color</td> <td>Outside</td> <td></td> </tr> <tr> <td>Hub Color</td> <td><input type="checkbox"/> Black/<input type="checkbox"/> Silver</td> <td><input type="checkbox"/> Black/<input type="checkbox"/> Silver</td> </tr> </table>		Left Wheel	Right Wheel	Spokes	Inside		Color	Outside		Hub Color	<input type="checkbox"/> Black/ <input type="checkbox"/> Silver	<input type="checkbox"/> Black/ <input type="checkbox"/> Silver
	Left Wheel	Right Wheel											
Spokes	Inside												
Color	Outside												
Hub Color	<input type="checkbox"/> Black/ <input type="checkbox"/> Silver	<input type="checkbox"/> Black/ <input type="checkbox"/> Silver											

Valid from 2022 Prices & Specifications Are Subject To Change Without Notice.

**Spinergy Sport Lite Extreme "SLX" 24 Spoke**

24" (540)  25" (559)  26" (590)

Spoke Color  Black  Red  Yellow  Blue  
 With Silver Hub With Black Hub With Black Hub With Black Hub  
 White  Neon Green  Pink  Orange  Purple  
 With Black Hub With Black Hub With Black Hub With Black Hub With Black Hub

Custom Color Spoke Pattern

		Left Wheel	Right Wheel
Spokes	Inside		
	Outside		
Hub Color		<input type="checkbox"/> Black/ <input type="checkbox"/> Silver	<input type="checkbox"/> Black/ <input type="checkbox"/> Silver



**Spinergy Lite Extreme "XLX" X-Laced-12 Spoke**

24" (540)  25" (559)  26" (590)

Spoke Color  Black  Red  Yellow  Blue  
 With Silver Hub With Black Hub With Black Hub With Black Hub  
 White  Neon Green  Pink  Orange  Purple  
 With Black Hub With Black Hub With Black Hub With Black Hub With Black Hub

Custom Color Spoke Pattern

		Left Wheel	Right Wheel
Spokes	Inside		
	Outside		
Hub Color		<input type="checkbox"/> Black/ <input type="checkbox"/> Silver	<input type="checkbox"/> Black/ <input type="checkbox"/> Silver



**Spinergy Blade "LXL" 18 Spoke**

24" (540)  25" (559)  26" (590)

Spoke Color  Black  Red  Yellow  Blue  
 With Silver Hub With Black Hub With Black Hub With Black Hub  
 White  Neon Green  Pink  Orange  Purple  
 With Black Hub With Black Hub With Black Hub With Black Hub With Black Hub

Custom Color Spoke Pattern

		Left Wheel	Right Wheel
Spokes	Inside		
	Outside		
Hub Color		<input type="checkbox"/> Black	<input type="checkbox"/> Black



**HANDRIM**

**Type**

Standard For 24", 25" or 26" Wheel Anodized Black

Vinyl Coated For 24", 25" & 26" Wheels Not available with Y-360 Billet Wheels . . . . .

Spinergy Silver Brushed Anodized For 24", 25" & 26" Not available with Y-360 Billet Wheels . . . . .

Natural Fit For 24", 25" & 26" Wheel

- Standard Grip (Not available with short tabs.) Not available with Y-360 Billet Wheels . . . . .
- Super Grip (Not available with short tabs.) Not available with Y-360 Billet Wheels . . . . .
- Without Thumb Grip (Not available with Y-360 Billet Wheels) . . . . .

Natural Fit(LT) For 24", 25" & 26" Wheel

- Standard Grip (Not available with short tabs.) Not available with Y-360 Billet Wheels . . . . .
- Super Grip (Not available with short tabs.) Not available with Y-360 Billet Wheels . . . . .
- Without Thumb Grip (Not available with Y-360 Billet Wheels) . . . . .

The Surge Handrims \* Not available with Y-360 Billet Wheels . . . . .

The Surge Handrims (LT) \* Not available with Y-360 Billet Wheels . . . . .

Spinergy Flex Rim Available only on Spinergy LX & XLX

The Q-Grip Handrims : anti-slip, latex-free, neoprene coating  
 \* Not available with Y-360 Billet Wheels

OMIT HANDRIMS

**TAB LENGTH**

Long Tab ( STD inside clearance 3/4") Not available with Y-360 Billet Wheels \* . . . . .

Short Tab (Inside clearance 1/2") \* Not available with Natural Fit Handrim with thumb grip . . . . .

Short Tab (Set closest to wheel cut off excess) \* Not available with Y-360 wheel . . . . .

**G CHAIR OPTIONS 1 / 3**

SEAT CUSHION	
<b>SUPRACOR® WHEELCHAIR CUSHIONS</b>	
<b>Stimulite® Contoured Cushion</b> *Black Upholstery only *Comes with Zipper Pouch <input type="checkbox"/> Extra Sensitive (\$35 up charge) <input type="checkbox"/> Sling Style Bottom (\$52 up charge) <input type="checkbox"/> Custom Size ( \$- CFP ) W(    ) x D(    ) <input type="checkbox"/> Extra Cover (\$104 up charge)	<input type="checkbox"/> W14"xD16" (CD1416) . . . . . E2603 <input type="checkbox"/> W16"xD16" (CD1616) . . . . . E2603 <input type="checkbox"/> W16"xD18" (CD1618) . . . . . E2603 <input type="checkbox"/> W18"xD16" (CD1816) . . . . . E2603 <input type="checkbox"/> W18"xD18" (CD1818) . . . . . E2603 <input type="checkbox"/> W18"xD20" (CD1820) . . . . . E2603 <input type="checkbox"/> W20"xD16" (CD2016) . . . . . E2603 <input type="checkbox"/> W20"xD18" (CD2018) . . . . . E2603 <input type="checkbox"/> W20"xD20" (CD2020) . . . . . E2603
<b>Stimulite® Slimline Cushion</b> *Black Upholstery only <input type="checkbox"/> Extra Sensitive (\$35 up charge) <input type="checkbox"/> Sling Style Bottom (\$52 up charge) <input type="checkbox"/> Custom Size ( \$- CFP ) W(    ) x D(    ) <input type="checkbox"/> Extra Cover (\$75 up charge)	<input type="checkbox"/> W14"xD16" (SM1416) . . . . . E2603 <input type="checkbox"/> W16"xD16" (SM1616) . . . . . E2603 <input type="checkbox"/> W16"xD18" (SM1618) . . . . . E2603 <input type="checkbox"/> W18"xD18" (SM1818) . . . . . E2603 <input type="checkbox"/> W18"xD20" (SM1820) . . . . . E2603 <input type="checkbox"/> W20"xD16" (SM2016) . . . . . E2603 <input type="checkbox"/> W20"xD18" (SM2018) . . . . . E2603 <input type="checkbox"/> W20"xD20" (SM2020) . . . . . E2603
<b>Stimulite® Corbee Pediatric</b> *Black Upholstery only <input type="checkbox"/> Extra Cover (\$75 up charge)	<input type="checkbox"/> W10"xD10" (PD1010) . . . . . E2603 <input type="checkbox"/> W12"xD12" (PD1212) . . . . . E2603 <input type="checkbox"/> W14"xD14" (PD1414) . . . . . E2603  <input type="checkbox"/> Extra Sensitive (\$35 up charge) <input type="checkbox"/> Sling Style Bottom (\$52 up charge) <input type="checkbox"/> Custom Size W(    ) x D(    ) ( \$- CFP )
<b>ROHO WHEELCHAIR CUSHIONS</b>	
<input type="checkbox"/> 4" HIGH PROFILE® QUADTRO SELECT® CUSHION *Black Upholstery . . . . . <input type="checkbox"/> Extra Cover (\$+57) . . . . . only. E2622-2623	
Choose Size	<input type="checkbox"/> W12"xD12" <input type="checkbox"/> W12"xD13" <input type="checkbox"/> W13"xD13" <input type="checkbox"/> W13"xD15" <input type="checkbox"/> W13"xD16" <input type="checkbox"/> W15"xD13" <input type="checkbox"/> W15"xD15" <input type="checkbox"/> W15"xD16" <input type="checkbox"/> W15"xD18" <input type="checkbox"/> W16"xD15" <input type="checkbox"/> W16"xD16" <input type="checkbox"/> W16"xD18" <input type="checkbox"/> W16"xD20" <input type="checkbox"/> W18"xD15" <input type="checkbox"/> W18"xD16" <input type="checkbox"/> W18"xD18" <input type="checkbox"/> W18"xD20" <input type="checkbox"/> W18"xD22" <input type="checkbox"/> W20"xD16" <input type="checkbox"/> W20"xD18" <input type="checkbox"/> W20"xD20" <input type="checkbox"/> W20"xD22" <input type="checkbox"/> W22"xD18" <input type="checkbox"/> W22"xD20" <input type="checkbox"/> W22"xD22" <input type="checkbox"/> Custom Size W(    ) x D(    ) ( \$+CFP )
Choose Size	<input type="checkbox"/> 3" MID PROFILE® QUADTRO SELECT® CUSHION *Black Upholstery only . . . . . <input type="checkbox"/> Extra Cover E2622-2623 <input type="checkbox"/> W15"xD15" <input type="checkbox"/> W15"xD16" <input type="checkbox"/> W16"xD16" <input type="checkbox"/> W16"xD18" <input type="checkbox"/> W18"xD16" <input type="checkbox"/> W18"xD18" <input type="checkbox"/> Custom Size W(    ) x D(    ) ( \$+CFP )
Choose Size	<input type="checkbox"/> 2" LOW PROFILE® QUADTRO SELECT® CUSHION *Black Upholstery only . . . . . <input type="checkbox"/> Extra Cover (\$+57) . . . . . E2622-2623 <input type="checkbox"/> W12"xD12" <input type="checkbox"/> W12"xD13" <input type="checkbox"/> W13"xD13" <input type="checkbox"/> W13"xD15" <input type="checkbox"/> W13"xD16" <input type="checkbox"/> W15"xD13" <input type="checkbox"/> W15"xD15" <input type="checkbox"/> W15"xD16" <input type="checkbox"/> W15"xD18" <input type="checkbox"/> W16"xD15" <input type="checkbox"/> W16"xD16" <input type="checkbox"/> W16"xD18" <input type="checkbox"/> W16"xD20" <input type="checkbox"/> W18"xD15" <input type="checkbox"/> W18"xD16" <input type="checkbox"/> W18"xD18" <input type="checkbox"/> W18"xD20" <input type="checkbox"/> W20"xD16" <input type="checkbox"/> W20"xD18" <input type="checkbox"/> W20"xD20" <input type="checkbox"/> Custom Size W(    ) x D(    ) ( \$+CFP )
<b>STAR CUSHIONS</b>	
<b>Galaxy Cushion</b> *Black Upholstery only <input type="checkbox"/> W14"xD14" ( GXY 1414-2) <input type="checkbox"/> W14"xD16" ( GXY 1416-2) <input type="checkbox"/> W16"xD14" ( GXY 1614-2) <input type="checkbox"/> W16"xD16" ( GXY 1616-2) <input type="checkbox"/> W16"xD18" ( GXY 1618-2) <input type="checkbox"/> W18"xD16" ( GXY 1816-2) <input type="checkbox"/> W18"xD18" ( GXY 1818-2) <input type="checkbox"/> W18"xD20" ( GXY 1820-2) <input type="checkbox"/> W20"xD16" ( GXY 2016-2) <input type="checkbox"/> W20"xD18" ( GXY 2018-2) <input type="checkbox"/> W20"xD20" ( GXY 2020-2)	Choose Zoning Options E2624 <input type="checkbox"/> Standard - Dual Valve <input type="checkbox"/> Dual Valve - Front to Back <input type="checkbox"/> Four Valve <input type="checkbox"/> Simple - Single Valve <input type="checkbox"/> Four Valve - Enhanced <input type="checkbox"/> Four Valve - Front to Back
<b>THE CURVE CUSHION</b> *Black Upholstery only <input type="checkbox"/> Extra Cover ( \$+ 40	<input type="checkbox"/> W10"xD10" <input type="checkbox"/> W10"xD11" <input type="checkbox"/> W10"xD11" <input type="checkbox"/> W10"xD12" <input type="checkbox"/> W11"xD12" <input type="checkbox"/> W12"xD12" <input type="checkbox"/> W12"xD13" <input type="checkbox"/> W12"xD14" <input type="checkbox"/> W13"xD11" <input type="checkbox"/> W13"xD12" <input type="checkbox"/> W13"xD13" <input type="checkbox"/> W13"xD14" <input type="checkbox"/> W14"xD14" <input type="checkbox"/> W14"xD15" <input type="checkbox"/> W14"xD16" <input type="checkbox"/> W15"xD14" <input type="checkbox"/> W15"xD15" <input type="checkbox"/> W15"xD16" <input type="checkbox"/> W16"xD14" <input type="checkbox"/> W16"xD15" <input type="checkbox"/> W16"xD16" <input type="checkbox"/> W16"xD17" <input type="checkbox"/> W16"xD18" <input type="checkbox"/> W17"xD16" <input type="checkbox"/> W17"xD17" <input type="checkbox"/> W17"xD18" <input type="checkbox"/> W18"xD16" <input type="checkbox"/> W18"xD17" <input type="checkbox"/> W18"xD18"

Valid from 2022 Prices & Specifications Are Subject To Change Without

**G CHAIR OPTIONS 2 / 3**

SEAT CUSHION	
<b>Exgel Kaji Cushion</b>	
<b>For Comfortable Sitting To Prevent Pressure Sores</b> <input type="checkbox"/> <b>Owl Regular(1.6" Thick)</b> Incontinence Cover Only	<input type="checkbox"/> W14"xD16" ..... E2603 <input type="checkbox"/> W15"xD16" ..... E2603 <input type="checkbox"/> W16"xD16" ..... E2603 <input type="checkbox"/> W18"xD16" ..... * No Custom Sizes E2603
<input type="checkbox"/> <b>Owl High(3.1" Thick)</b> Incontinence Cover Only	<input type="checkbox"/> W14"xD16" ..... E2603 <input type="checkbox"/> W15"xD16" ..... E2603 <input type="checkbox"/> W16"xD16" ..... E2603 <input type="checkbox"/> W18"xD16" ..... E2603 <input type="checkbox"/> W18"xD18" ..... * No Custom Sizes E2603
<input type="checkbox"/> <b>Owl Contour(4.3" Thick)</b> Incontinence Cover Only	<input type="checkbox"/> W14"xD16" ..... E2603 <input type="checkbox"/> W15"xD16" ..... E2603 <input type="checkbox"/> W16"xD16" ..... E2603 <input type="checkbox"/> W18"xD16" ..... E2603 * No Custom Sizes
<input type="checkbox"/> <b>Owl Deep Contour(4.3" Thick)</b> <input type="checkbox"/> W14"xD16" \$ 458    * No Custom Sizes- Incontinence Cover Only <input type="checkbox"/> W14"xD16" \$518 <input type="checkbox"/> W15"xD16" \$518 <input type="checkbox"/> W16"xD16" \$518 <input type="checkbox"/> W18"xD16" \$558	
<input type="checkbox"/> <b>Standard Regular(1.4" Thick)</b> Easy to Use Flat Style (superior pressure redistribution) <b>For Pressure</b> E2622-2623 <input type="checkbox"/> W12" x D12" \$368 <input type="checkbox"/> W13" x D13" \$368 <input type="checkbox"/> W14" x D14" \$368 <input type="checkbox"/> W14" x D16" \$368 <input type="checkbox"/> W16" x D16" \$368 <input type="checkbox"/> W16" x D17" \$368 <input type="checkbox"/> W17" x D16" \$368 <input type="checkbox"/> W17" x D17" \$368 <input type="checkbox"/> W18" x D16" \$391 <input type="checkbox"/> W18" x D18" \$391 <input type="checkbox"/> W18" x D19" \$440 <input type="checkbox"/> W18" x D20" \$440 <input type="checkbox"/> W19" x D19" \$440 * No Custom Sizes- Incontinence Cover Only	
<input type="checkbox"/> <b>Standard High(2.6" Thick)</b> Incontinence Cover Only    ..... E2622 *Black Upholstery only <input type="checkbox"/> W12" x D12" \$383 <input type="checkbox"/> W13" x D13" \$ 383 <input type="checkbox"/> W14" x D14" \$383 <input type="checkbox"/> W14" x D16" \$ 383 <input type="checkbox"/> W16" x D16" \$383 <input type="checkbox"/> W16" x D17" \$383 <input type="checkbox"/> W17" x D16" \$383 <input type="checkbox"/> W17" x D17" \$383 <input type="checkbox"/> W18" x D16" \$460 <input type="checkbox"/> W18" x D18" \$460 <input type="checkbox"/> W18" x D19" \$512 <input type="checkbox"/> W18" x D20" \$512 <input type="checkbox"/> W19" x D19" \$512 <input type="checkbox"/> W18" x D19" \$512	
<input type="checkbox"/> <b>Standard Anti-Thrust(2.6" Thick)</b> * No Custom Sizes Incontinence Cover Only	<input type="checkbox"/> W16 x D16 \$460    Prevents Unwanted <input type="checkbox"/> W18 x D16 \$500    Forward Movement of <input type="checkbox"/> W18 x D18 \$500    lower back and hip bone
<input type="checkbox"/> <b>Lite Regular(2.2" Thick)</b> <input type="checkbox"/> W16" x D16" \$374 <input type="checkbox"/> W18" x D16" \$397 <input type="checkbox"/> W18" x D18" \$397    * No Custom Sizes- Incontinence Cover Only	
<input type="checkbox"/> <b>Lite High(3.0" Thick)</b> <input type="checkbox"/> W16" x D16" \$408 <input type="checkbox"/> W18" x D16" \$431 <input type="checkbox"/> W18" x D18" \$431    * No Custom Sizes- Incontinence Cover Only	

**H CHAIR OPTIONS 3 / 3**

**POSITIONING BACK**

**\*Note : Actual height of the backrest will increase 2" or more.**

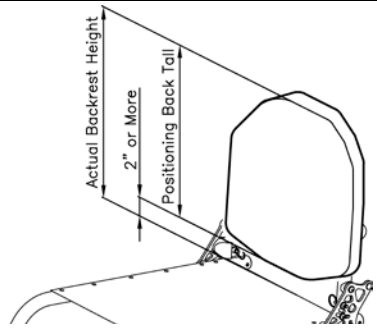

**ADI CARBON BACKREST (Support Contour-ACTIVE 2.5")** \*Not Available with Welded Side Guards

Mounting Hardware:  2 Point Pro  Quick Release

Height  <input type="checkbox"/> Add Privacy Flap (\$69 up charge)	<input type="checkbox"/> LOW (10" Tall) *Backrest Height requires 12" or more *Available 13"-19" width	Width ( " )	E2613
	<input type="checkbox"/> Medium (13" Tall) *Backrest Height requires 15" or more *Available 13"-19" width	Width ( " )	E2613
	<input type="checkbox"/> Standard (16" Tall) *Backrest Height requires 18" or more *Available 13"-19" width	Width ( " )	E2613
	<input type="checkbox"/> Custom Size ( " Tall) x ( " width) . . . . .		E2613

**ADI ALUMINUM BACKREST (Support Contour-ACTIVE 2.5")** \*Not Available with Welded Side Guards

Mounting Hardware:  2 Point Pro  Quick Release

Height  <input type="checkbox"/> Add Privacy Flap (\$69 up charge)	<input type="checkbox"/> LOW (10" Tall) *Backrest Height requires 12" or more *Available 10"-20" width	Width ( " )	E2613
	<input type="checkbox"/> Medium (13" Tall) *Backrest Height requires 15" or more *Available 12"-20" width	Width ( " )	E2613
	<input type="checkbox"/> Standard (16" Tall) *Backrest Height requires 18" or more *Available 14"-20" width	Width ( " )	E2613
	<input type="checkbox"/> Tall (18" Tall) *Backrest Height requires 20" or more *Available 16"-20" width	Width ( " )	E2613
	<input type="checkbox"/> X-Tall (20" Tall) *Backrest Height requires 22" or more *Available 16"-20" width	Width ( " )	E2613
	<input type="checkbox"/> Custom Size ( " Tall) x ( " width) . . . . .		E2613

**ADI ALUMINUM BACKREST (Support Contour-DEEP 4")** \*Not Available with Welded Side Guards\*Not Available with Lateral Supports

Mounting Hardware:  2 Point Pro  Quick Release

Height  <input type="checkbox"/> Add Privacy Flap (\$69 up charge)	<input type="checkbox"/> LOW (10" Tall) *Backrest Height requires 12" or more *Available 10"-20" width	Width ( " )	E2615
	<input type="checkbox"/> Medium (13" Tall) *Backrest Height requires 15" or more *Available 12"-20" width	Width ( " )	E2615
	<input type="checkbox"/> Standard (16" Tall) *Backrest Height requires 18" or more *Available 14"-20" width	Width ( " )	E2615
	<input type="checkbox"/> Tall (18" Tall) *Backrest Height requires 20" or more *Available 16"-20" width	Width ( " )	E2615
	<input type="checkbox"/> X-Tall (20" Tall) *Backrest Height requires 22" or more *Available 16"-20" width	Width ( " )	E2615
	<input type="checkbox"/> Custom Size ( " Tall) x ( " width) . . . . .		E2615

**ADI LATERAL SUPPORTS ( Lateral Supports are compatible with only active 2.5" ADI positioning back. )**

<input type="checkbox"/> Stationary Pad	Pad Size <input type="checkbox"/> Small (3" H x 3" D) <input type="checkbox"/> Medium(3" H x 4" D) <input type="checkbox"/> Large(4.5" H x 4.5" D) <input type="checkbox"/> Large(4" H x 6" D)
	<input type="checkbox"/> Pair . . . . .
	<input type="checkbox"/> Left side only or <input type="checkbox"/> Right side only . . . . .
<input type="checkbox"/> Swing-Out	Pad Size <input type="checkbox"/> Small (3" H x 3" D) <input type="checkbox"/> Medium(3" H x 4" D) <input type="checkbox"/> Large(4.5" H x 4.5" D) <input type="checkbox"/> Large(4" H x 6" D)
	<input type="checkbox"/> Pair . . . . .
	<input type="checkbox"/> Left side only or <input type="checkbox"/> Right side only

**OTHER**

- ADI Transfer Board  21" (ADV21)  24" (ADV24)  29" . . . . . (ADV29).
- ADI Push and Transfer Gloves **Leather** (one size fits) . . . . .
- ADI Carbon Solid Seat (Wide: 18" Max, Depth: 20" ) ✘ ONLY AVAILABLE WITH COLOURS NON-REMOVABLE SIDE GUARDS

**VARILITE® Seating Systems Available**

Please visit for all options. [www.varilite.com](http://www.varilite.com)

**NOTE**

Valid from 2022 Prices & Specifications Are Subject To Change Without Notice.