



Thera **Lite**

Radiance

Mood and Energy Enhancing Light

with USB and Qi Wireless Charging Features
and Built-In Alarm Clock

USER GUIDE

Thank you for purchasing the TheraLite Radiance.

Please read this manual in its entirety. For more information on light therapy, please visit carex.com.

Theralite Radiance has been designed with your needs in mind. It projects light from above with an adjustable angle and multiple light settings for optimal light therapy. The Radiance also features Qi wireless charging and USB charging making it the perfect companion at home or at the office.

UV-free LED technology and a comfortable color temperature ensures you experience a safe, comfortable therapeutic light. The adjustable lamphead lets you switch from therapy lamp to desk light with the turn of the knob.

Bright Light Benefits

Daily exposure to bright light helps to maintain your circadian rhythm, boost energy and manage sleeping patterns. Light therapy is also the first line of recommended treatment for the Winter Blues.

For many, morning sun exposure is limited by work, school or other commitments, even in the summer. The TheraLite is a bright light therapy lamp designed to fill this gap.

INCLUDED ITEMS

TheraLite Radiance and User Guide

⚠ WARNING: This light should not be used on patients with macular degeneration. **ALWAYS** consult a physician before using this product.

TheraLite Radiance Light Therapy Desk Lamp
Model Number: FGE80700 0000

OPERATING INSTRUCTIONS

⚠️ WARNING: RISK OF ELECTRICAL SHOCK

- Turn off the power before performing any maintenance.
- Verify that supply voltage is correct by comparing it with the lamp label information.
- If you have eye problems or have had eye surgery, you should consult your doctor or ophthalmologist before you use any form of light therapy. Certain eye and eye-related conditions may respond unfavorably to light therapy.
- As with any electrical device, **DO NOT** use the TheraLite in or near water.

⚠️ CAUTION: RISK OF INJURY

- Avoid direct eye exposure to the light source while it is on.

General Safety Information and Precautions

- This product is suitable for indoor use only.
- **DO NOT** overuse the TheraLite. Overuse may cause irritability, excessive energy or difficulty falling asleep at bedtime.
- It is **NOT** necessary to stare into the light. Read, work or talk on the phone during your light therapy session.
- During the first few uses, your TheraLite may give off an odor; this is harmless, will **NOT** affect the use, and will quickly disappear.
- **ALWAYS** use in a well-ventilated area away from other heat sources and ensure that air can flow freely around the lamphead when the product is in use.
- To reduce the risk of death, personal injury or property damage from fire, electric shock, falling parts, cuts/abrasions and other hazards, read all warnings and instructions included with and on the fixture box and all fixture labels.
- For residential installation: If you are unsure about the installation or maintenance of the lamps, consult a qualified licensed electrician and check your local electrical code.
- **DO NOT INSTALL DAMAGED PRODUCT!**
- The external flexible cable or cord of this lamp cannot be replaced; if the cable or cord is damaged, the lamp will be destroyed.
- To avoid injury or damage to the fitting, ensure that power leads and screws are secure before connecting the power.
- Young children should be supervised to ensure that they **DO NOT** play with the portable lamp.
- Handle the fitting and/or shade with care to avoid any damage or breakage.
- Select a suitable location away from liquids and hazards.
- Ensure that the fitting **DOES NOT** come in contact with corrosive chemicals, etc.
- To clean, wipe with a damp clean cloth. **NEVER** soak the fixture with water.

Installation Requirements

1. Select a suitable location for the lamp.
 - Ensure it is on a flat and stable surface.
 - This product is suitable for indoor use **ONLY**.
 - **DO NOT** place flammable material near or over the fixture.
 - Ensure the fixture is not installed next to any air vents and is **NOT** in any moist or damp areas.
2. Take care **NOT** to pull any electrical wires during unpacking as this may damage the connection.
3. Check whether the fitting has been damaged during transport.

DO NOT operate/install any product which appears damaged in any way. Return the complete product to the place of purchase for inspection, repair or replacement.

DO NOT plug into the main power socket outlet before or during assembly. Only do so after the portable lamp is fully assembled and ready to use for the first time.

Installation Directions



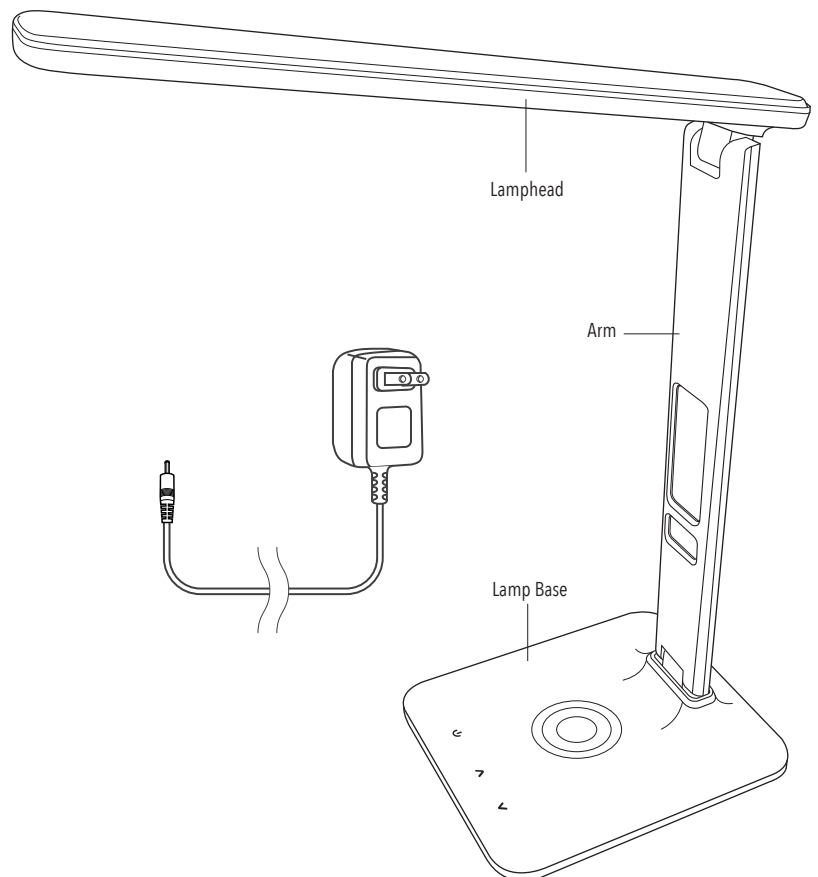













1. Remove all packaging material from the product.
2. Select a suitable location for the light fitting. See the *Installation Requirements* above.
3. Adjust the head of the lamp to the desired angle.
4. Insert the fixture plug into a properly grounded outlet. Ensure it is fully plugged in.
5. Use switch to turn the lamp on/off.



Initial Setup







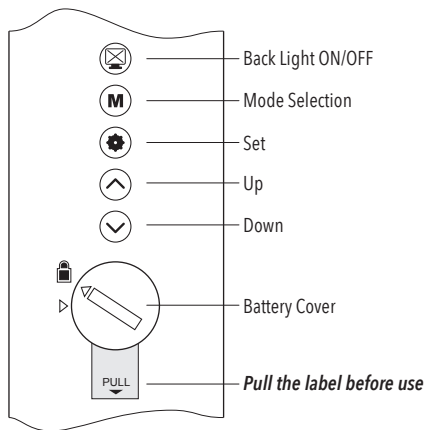







When you first power up your device, a tone will sound and the LCD screen will display [**12:00 1/1THU**].

To Set Date and Time







1. Toggle between 12HR and 24HR clock format settings by simply pressing the  arrow.
2. Press the  icon to begin setting the time.
3. Use the   arrows to set the hour. The [**PM**] symbol will appear when selecting an afternoon/evening time. If selecting an AM time, there will be no corresponding symbol.
4. When you are finished selecting the hour, press . You will now be prompted to set the minutes.
5. Use the   arrows to select the minutes.
6. When you are finished selecting the minutes, press . You will now be prompted to set the year.
7. Use the   arrows to select the year.
8. When you are finished selecting the year, press . You will now be prompted to set the month.
9. Use the   arrows to select the month.
10. When you are finished selecting the month, press . You will now be prompted to set the date.
11. Use the   arrows to select the date.
12. Press  to return to normal mode.





To Set the Alarm

1. Press .
2. Press .
3. Use the   arrows to set the hour. The [**PM**] symbol will appear when selecting an afternoon/evening time. If selecting an AM time, there will be no corresponding symbol.
4. When you are finished selecting the hour, press . You will now be prompted to set the minutes.
5. Use the   arrows to select the minutes.
6. Press  again. You will now be prompted to set the snooze timer.
7. Use the   arrows to select the minutes. You can choose anything between 0-60 minutes.
8. Press . You will now be prompted to select an alarm tone.
9. Use the   arrows to select a tone.
10. Press  to return to normal mode.

To Turn On the Alarm

1. Press .
2. The alarm icon will appear, which is [].
3. Push the  arrow once to turn the alarm on. A [] will appear indicating the alarm is on.
4. Push the  arrow again to enable the snooze alarm. A [] icon will appear indicating that the snooze feature is set.
5. Press to  return to normal mode.

To Turn Off the Alarm

1. When alarm is set, it will sound for one full minute and then enter snooze mode (if you have enabled it).
2. Push any button to turn alarm off.
3. If snooze is enabled, alarm will sound again after the designated amount of time you selected in the snooze setting. To turn this off, press  and then press the  arrow until the snooze icon [] goes away.

Thermometer Settings

When in normal mode, toggle between Celsius and Fahrenheit by simply pressing the  arrow.

Charging Instructions

Qi Wireless Charging

Make sure that the charging pad on the base of the therapy lamp is clear from all objects, especially metal or magnetic objects. Place your mobile device face up on top of the area of the lamp base with the charging symbol. Move the mobile device slowly until a charging icon displays on your device's screen. The icon indicates the mobile device is properly positioned and charging.

USB Charging

In the event that your device is not compatible with Qi wireless charging, you can use the USB port located at the back of the desk lamp to charge your device. Be sure the lamp is plugged in. Connect a standard USB cable (not included) to the USB port on one end and then connect your device on the other end of the cable. A charging icon should display on the screen of your device, indicating that it is properly charging.

Operating the Light

1. Use the Light ON/OFF [⏻] touch button to turn the lamp on.
2. Press [^] to increase the brightness. Press [v] to lower the brightness.

Using Your TheraLite for Therapy

For those with mild to moderate Winter Blues, sleep or circadian rhythm issues, regular daily use of the TheraLite can help provide relief. For most conditions, use shortly after waking or in the morning.

Place the TheraLite Radiance above your line of sight, where possible, to maximize the light reaching your eyes. You should be facing the lamp with eyes open during sessions, but you do not need to look directly at the light. Over the first few days of use, assess the effect and, if necessary, lengthen or shorten the session time based on your response.

Symptoms of Overuse

Negative effects are rare with light therapy. However, if you experience increased irritability, excessive energy, and/or any consistent discomfort during or after use, decrease session time or move the light further away. Using the lamp late in the afternoon or in the evening is not advised, as this may disrupt your sleep. It is recommended that you consult your doctor before beginning any bright light regimen.

Light Therapy Basics

LUX or the light intensity at a specific distance from the light is the common term used in bright light therapy. The chart below details the average treatment times for the Winter Blues based on your eyes' proximity to the lamp.

Specifications

Power: 120V, 60Hz, 18W

Size: 12.5" x 5.5" x 14.5" / 31.5cm x 14cm x 37cm

Lens: High-impact polycarbonate

Light Intensity: 10,000 LUX at 5" / 10cm

Light Source: 105 LEDs, 3000K, 100% UV Free

Angles: Adjustable

Disclaimer

TheraLite is an innovative light supply system and is not a listed medical device in the USA.

Warranty

Your lamp is maintenance-free and should provide years of service. The TheraLite has a one-year limited warranty from the date of purchase by the original purchaser. Please retain proof of purchase to ensure eligibility for warranty coverage. Compass Health Brands may choose to repair or replace a defective unit. Shipping costs are the responsibility of the product owner. Misuse, abuse, accidental or incorrect operation, contrary to the instructions, will void a warranty claim.

COMPASSHEALTH

Made in China
42-FGE80700 0000_03 © 2021

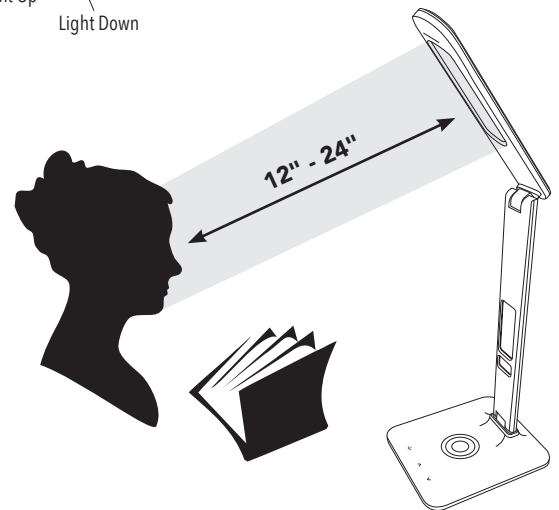
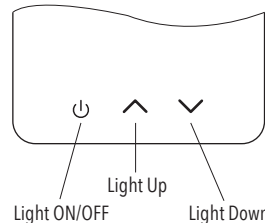

For Therapy: Adjust to the best angle so the light shines downward toward your eyes.

DISTANCE	SESSION TIME
5" / 13cm	30 minutes
7" / 18cm	60 minutes
10" / 25cm	120 minutes



TheraLite is an innovative light supply system and is not a listed medical device in the USA.

READ USER GUIDE PRIOR TO USE.