

molift[®] **NOMAD**



CE

BM15101 Molift NOMAD English

molift[®]
a part of Etac

OPERATOR MANUAL

Table of content

General advice	3
<i>Explanation of symbols</i>	3
<i>Before using the patient lifter</i>	3
<i>Responsibility</i>	3
Safety precautions	4
<i>General</i>	4
<i>If defects or faults occur</i>	4
<i>Lift and transfer</i>	4
About the product	5
<i>Main parts</i>	5
<i>Safety devices</i>	5
Technical data	6
Assembly/disassembly	7
<i>Assembly</i>	7
<i>Checklist after mounting</i>	7
<i>Disassembly</i>	7
<i>Storage and transportation</i>	7
Operation	8
<i>Functions</i>	8
<i>Operating the lifter</i>	8
<i>Emergency stop and emergency lowering</i> ..	8
<i>Battery care</i>	8
<i>Charging</i>	9
<i>Electrical system</i>	9
<i>Lift and transfer</i>	10
<i>Checklist before use</i>	10
<i>Using lifting slings</i>	10
<i>Climbing</i>	11
<i>Rail system</i>	12
Trolley.....	12
Accessories	14
<i>Lifting sling</i>	14
Sling size guide.....	15
<i>Sling bag</i>	15
<i>Molift NOMAD Attachment arm</i>	15

Maintenance	16
<i>Cleaning</i>	16
<i>Monthly maintenance</i>	16
<i>Periodic inspection</i>	16
<i>Troubleshooting</i>	16
<i>Service</i>	17
Service light codes	17
<i>Labelling</i>	17
Checklist for periodic inspection	18

IMPORTANT!

The patient lifter is only meant to be used by qualified personnel.

The manual shall not be handed over, or made available to, any unauthorised third party, without a prior written consent from Etac Supply Gjøvik. Existing laws, conventions and agreements protects all documents. No extract of this documentation can be reproduced, used or transferred without prior written consent from Etac Supply Gjøvik. Violation of these regulations may lead to judicial repercussions and economic responsibility. Industrial rights are reserved.



Etac AS, Etac Supply Gjøvik

Hadlandsveien 2

2816 Gjøvik, Norway

Teleph: (+47) 40001004

Fax: (+47) 40001008

www.molift.com

molift@etac.com

General advice

This user manual contains important safety instructions and information regarding the use of the lifter. Carefully read the manual before using the lifter in order to be familiar in the function and use of the lifter.

Explanation of symbols



This symbol is used to point out instructions and information related to work place safety where injury may occur if the information is disregarded or ignored. Follow these instructions, be careful and attentive at all times.



This symbol indicates important information regarding the use of the equipment. If not taken into consideration, it may lead to damage or functional defects to the lifter or other equipment.



This symbol indicates important and useful information. If taken into consideration, it will help the operator of the lifter to work efficiently. It may help simplify routines and to explain complicated facts.

Before using the patient lifter

Before using a patient lifter, the operator must be trained accordingly. Practice lifting a colleague, and be lifted by others. It is important not only to know how to move another person using the lifter, but also how it is to be lifted. Try out and practice using all the relevant slings for the different types of lifter and movement you may encounter. Before lifting a person, you should explain the procedure.

When using the lifter, it's also important to use the correct sling and accessories according to:

- type of disability
- size
- weight
- type of movement

Responsibility

Please read these operating instructions carefully before putting the product into operation. We assume no liability for damage or malfunctions resulting from failure to comply with the instructions. Warranty claims must be made immediately on detecting the defect. Remember to quote the serial number. Consumable parts are not subject to the warranty.

All technical information, data and instructions for operation contained in these operating instructions were up-to-date at time of print and are compiled on the basis of our experience and to the best of our knowledge. We reserve the right to incorporate technical modifications within the scope of further development of the product described in this manual. No claims can be derived from the information, illustrations or descriptions contained in these instructions. We assume no liability for any damage or malfunction caused by operating errors, noncompliance with these operating instructions or inappropriate maintenance. We expressly point out that only genuine Molift spare parts and accessories approved by us may be used. For safety reasons, the fitting and use of spare parts or accessories, which have not been approved, and unauthorized modification or conversion of the product, are not permitted. Etac Supply Gjøvik will accept no liability for damages resulting from such acts.

With the exclusion of product liability, Etac Supply Gjøvik is liable for faults or omissions on its part within the scope of the warranty obligations stated in the purchase contract. Claims for damages are excluded, irrespective of the legal reason from which such claims are derived. Only documentation belonging to the actual equipment is valid.

Any failure to comply with the safety regulations and precautionary measures stated in these operating instructions renders the declaration of conformity supplied with the system in accordance with Council Directive (93/42/EEC) concerning medical devices invalid.

Safety precautions

General

Before putting a Molift NOMAD into operation, the operator must ensure that the lifter and accessories are in good working order, especially with regards to safety.

All instruction and information in this manual regarding safety and general precautions must be read, understood and followed carefully. Any disregard to these precautions may result in personnel injury or damage to the equipment. The lifter must be taken out of service immediately, or not returned to service, if faults and/or irregularities that may have influence on the safety are discovered.

Safety devices and -equipment must not be removed, disabled or in any other way altered. A Molift NOMAD shall only be used when all safety devices and equipment is in place and fully operational.



The lifter is designed for indoor use only, and should not be exposed to sun for a longer period.



The lifter has an expected lifetime of 10 years or 30 000 lifts with max load (SWL), when all recommended service is performed.



Medical electrical equipment requires special precautions regarding electro-magnetic compatibility (EMC). Portable or mobile radio communication equipment may affect the medical electrical equipment, and should be kept minimum 25 cm (10 inches) from the lifters electronics.

If defects or faults occur

The lifter must be switched off immediately if one of the following conditions occur;

- damage to electrical devices or cables, or damage to parts of electrical insulation
- damage or failure on safety devices



If the lifting movement does not start when the corresponding button is pressed, please consult the troubleshooting table in the maintenance chapter to locate the fault.

Injury to personnel or equipment may occur if Molift NOMAD is used in an incorrect manner and if:

- covers are removed by unauthorized personnel
- used incorrectly
- insufficient maintenance
- load exceeds maximum limit. The maximum load stated in this manual and on the lifter is the maximum load
- unauthorized repair of electrical devices or cables

Lift and transfer

Several factors have to be considered during movement of the lifter:

- the user shall sit as low as possible facing the direction of movement.
- there is no obstacles in the moving area of the lifter.

Stand to the side of the user when lifting. Ensure that arms and legs are clear of the chair, bed etc. Try to maintain eye contact with the user - this will help the user feel safe and comfortable.



Pay close attention to your actions. Ensure that all four loops of the sling are securely fastened to avoid the user slipping or falling.



Make sure that there are no damages on the lifter or lifting belt, or accessories, before lifting.



Molift slings shall ONLY be used to lift persons. NEVER use the sling to lift and/or move objects of any kind.



Molift NOMAD should not be run constantly for more than 2 minutes (with maximum load), and rest for minimum 18 minutes.

About the product

Molift NOMAD is a portable ceiling lifter intended for lifting and transferring persons. The lifter is made out of light materials and has a battery. It can be used in institutions with various needs, making it necessary to move the lifter between different rooms.

The lifter has intelligent electronics with soft start/stop, and a counter to register the number of lift cycles.

Main parts

The lifter consists of a chassis with motor, lifting belt, electronics and battery. A rail system with a trolley is necessary for attachment of the lifter. The lifter has four hooks for attaching the sling with the user.

The lifter can be attached to the trolley directly, or by using an attachment arm. This makes it easy to move between the different rail systems. A climbing strap on the trolley makes it possible to climb from one rail system to another with a user suspended.

Safety devices

Molift NOMAD is equipped with several safety devices, which are intended to prevent personal injury or damage to equipment in the case of incorrect use.

- The lifter has an overload sensor which prevents the lifter from lifting too much. If the weight of the patient is too high, the lifter will stop.
- The lifting hooks are designed to prevent the lifting sling from falling off.
- Electrical system has a protection against overheating. If the temperature on the circuit card is too high, the lifter will stop, and you will have to wait until the temperature goes down.
- The lifter has a sensor which will stop the lifter if the lifting belt is not tight, to avoid it curling up.
- The electrical system registers the lifter's operating time, and gives a signal when service is required.
- The battery lamp will illuminate when the lifter needs charging, and an audible signal will sound.
- The lifter features emergency stop and emergency lowering.

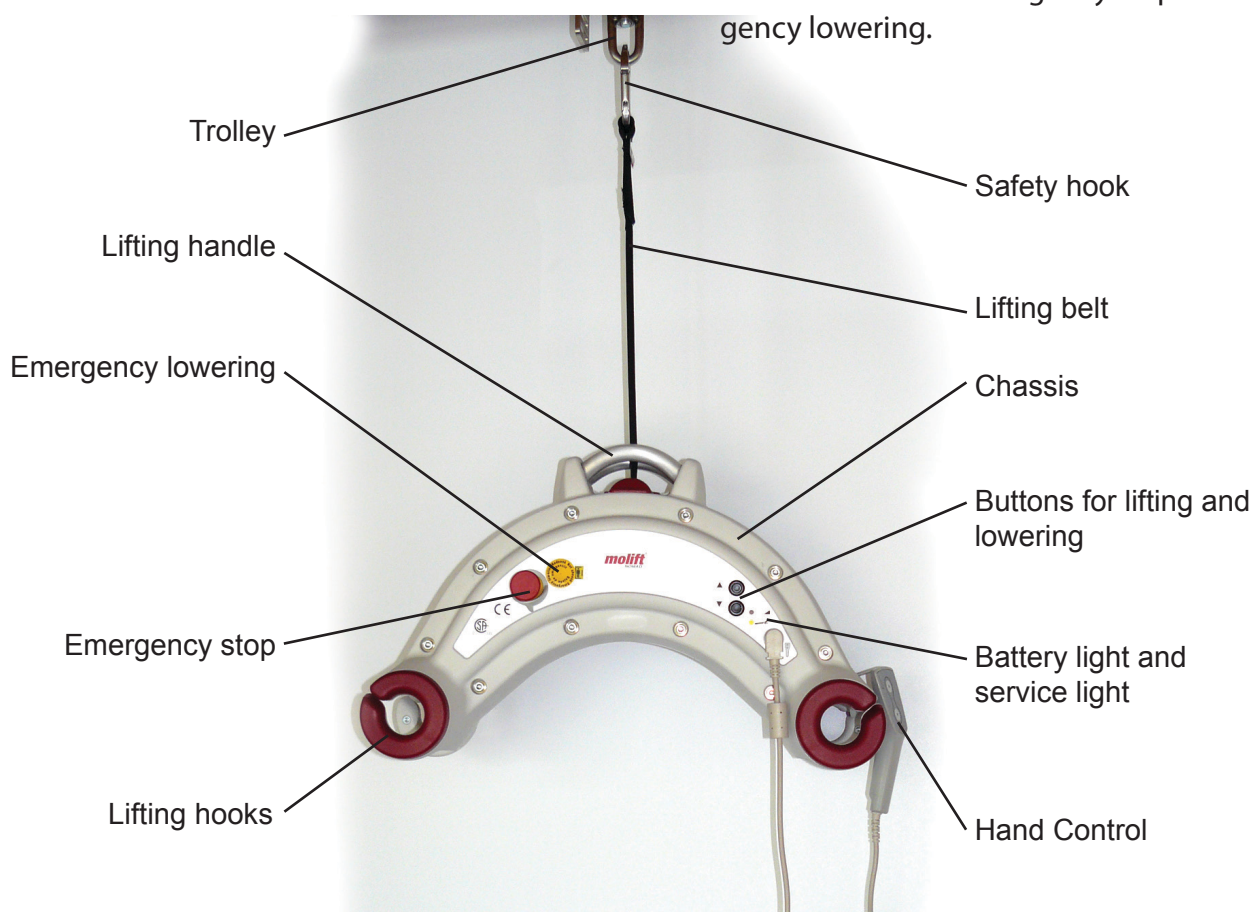

Technical data

Weight, total:

6,8 kg

Material:

Fibre armoured plastic and aluminium

Motor:

24 VDC

Battery:

26,4 V NiMH 2,2 Ah (Type EMP 2200CS)
Art.no 1221115

Battery charger:

Type 2215 10-20 cells

Protection:

IP24

Lifting capacity, SWL (Safe Working Load):

255 kg (560 lbs), adjustable to lower loads

Lifting height:

2 meters

Lifting Speed:

23 mm/sec w/load,

26 mm/sec without/load

Number of lifts with fully charged battery:

approx 60 (standard lifts 75 kg, 50 cm)

Sound level, max. A-weighted sound power level:

$L_{WA} = 68,8$ dB

Operating forces:

Buttons on hand control: 3,4 N

Buttons on lifter: 1,3 N

Measurements:

522 x 200 x 330 mm (LxBxH)

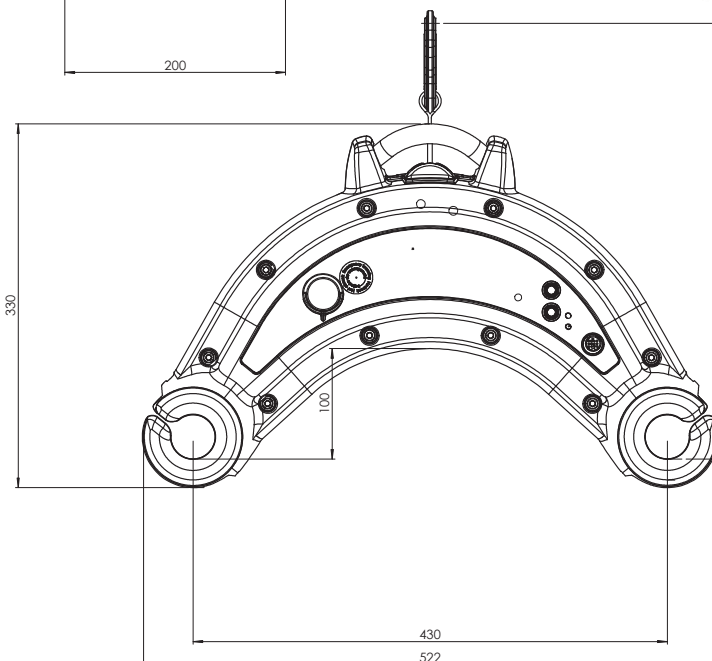
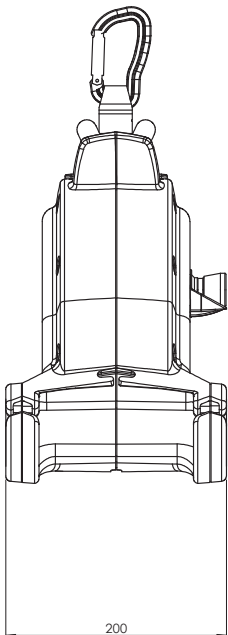

Measurements in illustrations below are in millimetres.

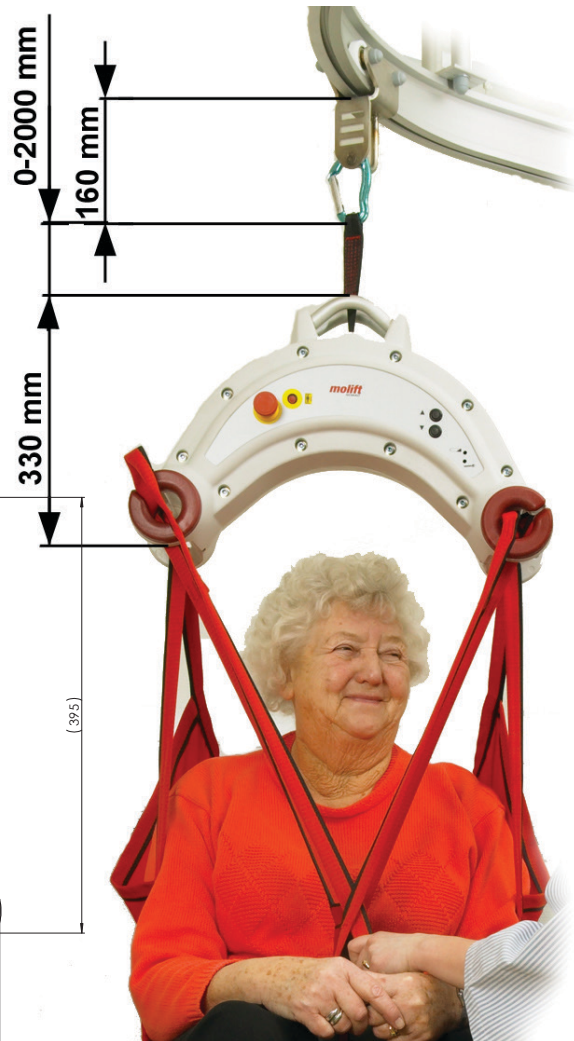

Assembly/disassembly

To be able to operate the Molift NOMAD, the operator must have good knowledge of the lift, including assembly and preparation before use.

Assembly

The lifter shall only be mounted on a rail system with a capacity on 255 kg or higher.

If the Molift NOMAD is mounted on a rail system with a lower lifting capacity, the lowest capacity also applies for the lifter.

Etac Supply Gjøvik has the system liability only when the rail system with trolley is mounted by authorized service representative/dealer or Etac Supply Gjøvik.

Take care that the lifter do not get damaged by hitting the floor or walls. Danger of personal injury if the lifting hooks are damaged.

- Attach the safety hook on the lifting belt on the attachment arm.

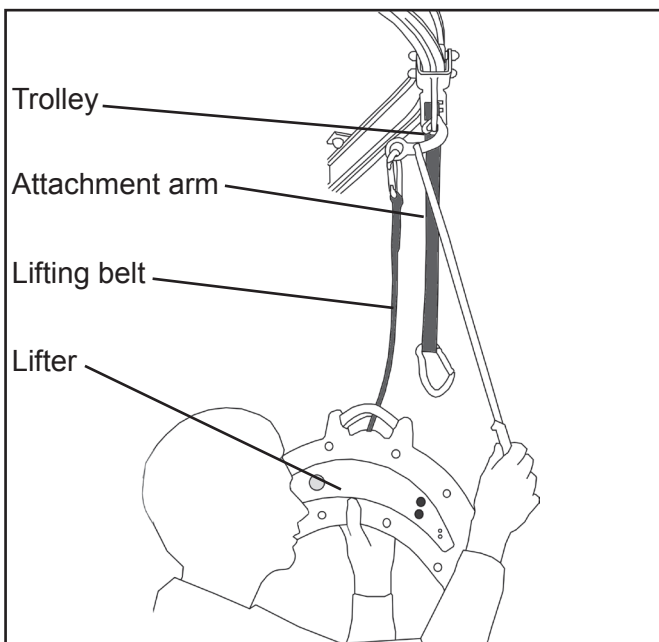

- Hook the attachment arm to the trolley. The arm will swing up when the lifter is hanging in the hook.
- Alternatively, the lifting belt can be hooked directly onto the trolley.
- Connect the hand control unit to the lifter.

- Reset the emergency stop button.

Checklist after mounting

- Check that the lifter has no visible damage or missing parts.
- Check that the batteries are sufficiently charged.
- Make sure that the lifter is properly attached to the trolley and attachment arm, and that the safety hook is locked.
- Check that the lifter functions correctly by running it up and down.

If any damage or faults occur on the lifter or the rail system, contact your local service representative/dealer or Etac Supply Gjøvik immediately. The lifter shall not to be used.

Disassembly

- Lower the lifter enough to hold it.
- Untighten the lifting belt and remove it from the trolley using the attachment arm, or release the safety hook.
- The lifter can be moved.

The control electronic has a power saving feature, which puts the system into stand by after a while of no activity. Activate one button and the service lamp will give a green light to show that the lifter is ready for use.

Storage and transportation

- Storage: For long time storage it is recommended that the battery is removed and the emergency stop button is activated. The lifter can be stored and transported under the following conditions:



- Pressure: 70 - 106 kPa
- Humidity: 15 - 93 %
- Temperature: -25 - 70 °C
- The lifter is designed for use at standard room temperatures (+5 to +40°C). Following storage or transport at other temperatures leave the lifter in a room with a suitable temperature until it reaches a safe operating temperature.

Operation

Functions

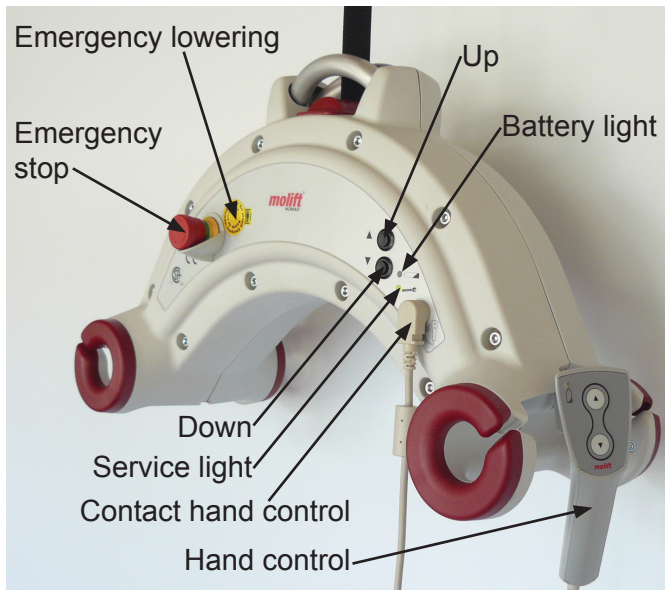

- If the lifter don't move, charge the battery, and try the emergency lowering button again. *Do not run the lifter when connected to the charger!*
- If none of the actions above works, the user must be lowered manually. Call for assistance.



If the Molift Nomad is operated by the user alone, the Emergency Stop and Emergency lowering button is difficult to operate. Make sure to have a mobile telephone or other communication device available.



If the reason for failure causing an emergency lowering is unknown or if it is a result of failed component, contact your local service representative/dealer or Etac Supply Gjøvik.

Battery care

The batteries of the Molift NOMAD is a 26,4 V cell unit that is placed inside the chassis.

Operating the lifter

Connect the hand control cable to the plug on the back side of the lifter. The hand control has two buttons which gives the operator excellent control of the movement of the lifter up and down. Two buttons with the same function are placed on the right front side of the lifter.

Emergency stop and emergency lowering

All Molift lifters are equipped with emergency stop and lowering. The emergency stop button will cut the power to the motor, and is situated on the left front side of the chassis. Turn the button clockwise to reset. Charging and emergency lowering does not work if the emergency stop is activated.

It is possible to perform an emergency lowering in case of an electronic malfunction or uncontrolled stop. There is an emergency lowering button on the left front side of the chassis with a yellow seal. Move the lifter to a suitable location to lower the user.

- Puncture the seal and press the emergency lowering button. The lifter will make a smoothly movement downwards.

The lifter has a battery light on the hand control which illuminates when the battery voltage drops below a certain level. If there is no hand control connected the battery light on the lifter will illuminate when battery level is low. There will also be an audible alarm, which indicates that the battery needs charging. There is still enough capacity to lower the patient.



If the battery is discharged during a lift, it is always enough power to lower the user down again.

Charging

The charger can be placed on the wall or a table and connected to the power outlet. The Charger must be placed or installed in a way that makes it easy to disconnect mains cable. The charging light on the charger gives a yellow light when the charger is ready for use and there is no hand control placed in the charger.

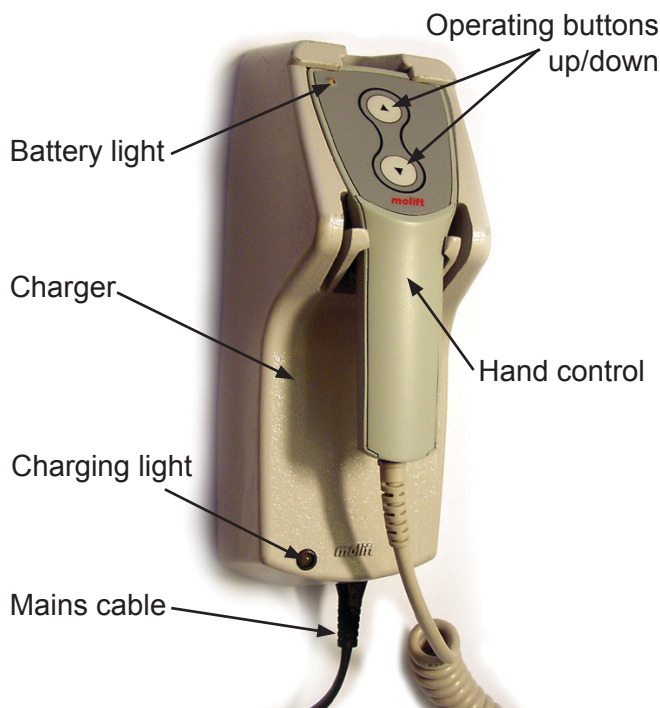

Description of charging light

Charging light	Mode
Yellow	Ready for use, no battery connected
Yellow	Initialization
Orange	Fast charge
Green/yellow	Top-off charge
Green	Trickle charge
Orange/green	Error

Place the hand control in the charger, make sure the cable is connected to the lifter. After a few seconds the charger light will change from yellow to orange, indicating that the battery is charging. If the charging light gives a constant green light, this means the batteries are fully charged. The lifter can not be used while charging the batteries.

 *If the emergency stop button is activated the batteries will not charge.*

 *The battery will not achieve full capacity before it has been fully charged and discharged a couple of times.*

The lifter can be operated without hand control. The lifter is then equipped with a special charger with a contact to be plugged in the hand control contact on the lifter when charging. Both chargers have the same functions.

Electrical system

On the front right side of the lifter there is a service light which will give a signal when the lifter needs service. When there is a green light, the lifter can be used normally. If there is no light, push one of the up/down buttons to activate the electronics, and the service lamp will illuminate.

The electrical system has a power save function which will turn off the electrical system after ten minutes without activity. All lights will turn off. The system is activated when pushing one of the operating buttons.

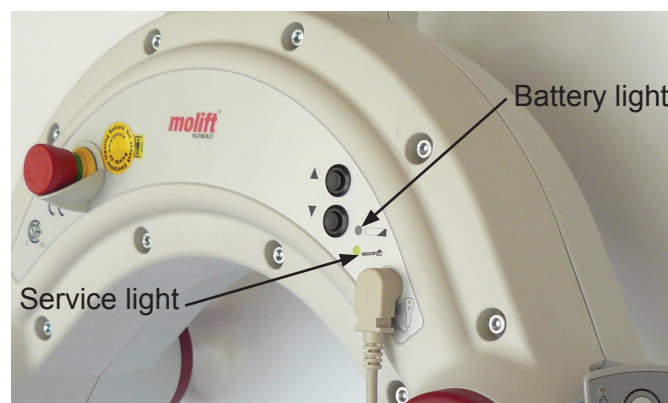



If the lifter is run up and down constantly for a longer period, the electronics may be overheated, and then the lifter will stop. The service diode will give a yellow flashing signal until the lifter has cooled down sufficiently to work again.

If the lifting belt is untight, the lifter will stop to avoid the belt from rolling in incorrectly. Run lifter up to tighten belt.

Lift and transfer

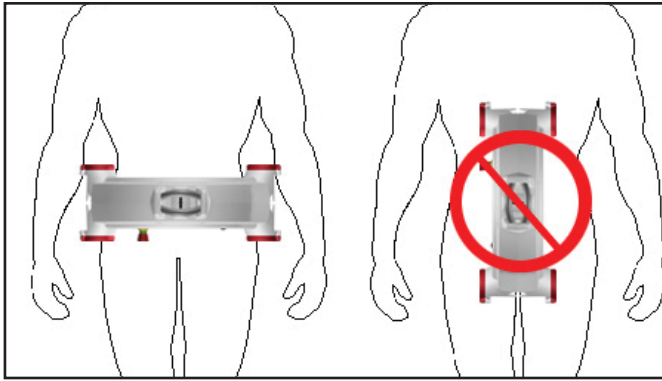
The suspension shall always be positioned across the user as shown left in the illustration below.



 When using slings intended for two point suspension, the suspension shall be used diagonally, i.e. loops from the sling shall be fastened on hooks diagonally opposite.

When transferring the user shall sit as low as possible facing the direction of movement.

Be careful during movement - the suspended user may swing somewhat during turns, stops and starts. Be particularly careful when manoeuvring close to furniture to prevent the suspended user from colliding with these objects. It is preferred to turn the user to face the moving direction.

 Check that the lifting belt don't curl when raising.

 The lifter is only to be used for transferring over short distances. It is not a replacement for wheelchairs or similar.

Checklist before use

- Check that the lifter has no visible damage or missing parts.
- Check that the batteries are sufficiently charged (no light on battery light on hand control or lifter).
- Check that the service light is green, meaning no service is needed.
- Make sure that the lifter is properly attached to the trolley and attachment arm, and that the safety hook is locked.
- Check that the lifter functions correctly by running it up and down.

 If any damage or faults occur on the lifter or the rail system, contact your local service representative/dealer or Etac Supply Gjøvik immediately. The lifter shall not to be used.

Using lifting slings

 It is recommended to use Molift Easy slings. Slings from other manufacturers may have other specifications leading to unexpected instability and possible injury to personnel.

 Torn, cut, frayed or broken slings can fail, resulting in serious injury to the user. Use slings in good condition only. Destroy and discard old, unusable slings.

 Please see the user manual following each sling for specific user instructions.

Climbing

With Molift NOMAD it is possible to climb between two rail systems, and then we can avoid cut-outs above the doors. There must be a trolley with a climbing belt present on both rail systems.

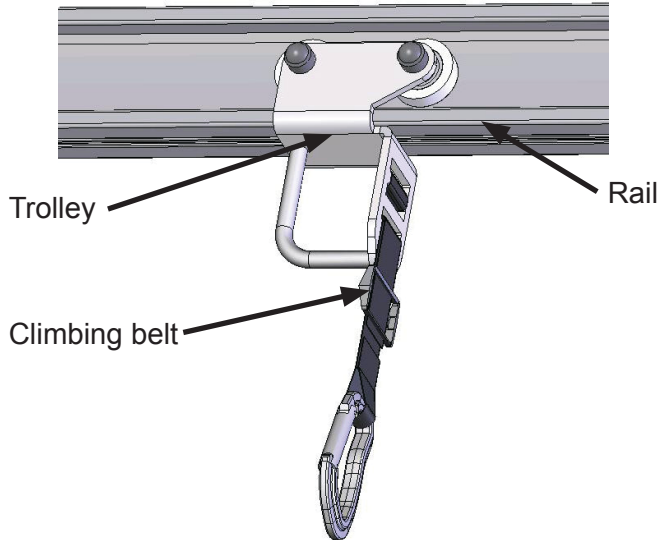

- Move the lifter until it stops at the end of the rail, and move the trolley on the opposite side as close as possible.

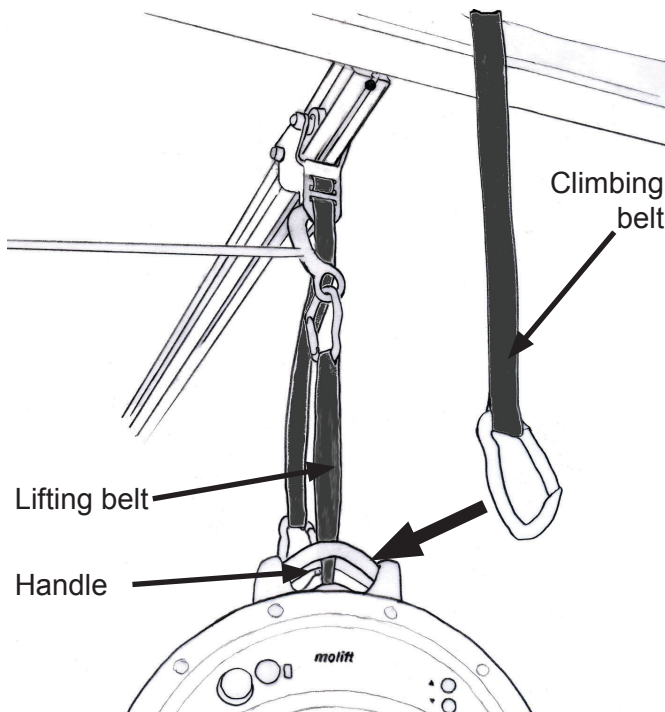

- Raise the lifter until it is possible to attach the climbing belt on the opposite trolley to the lifters handle.

- Lower the lifter until it hangs in the climbing belt only.

 *The lifter will stop if the lifting belt is untight.*

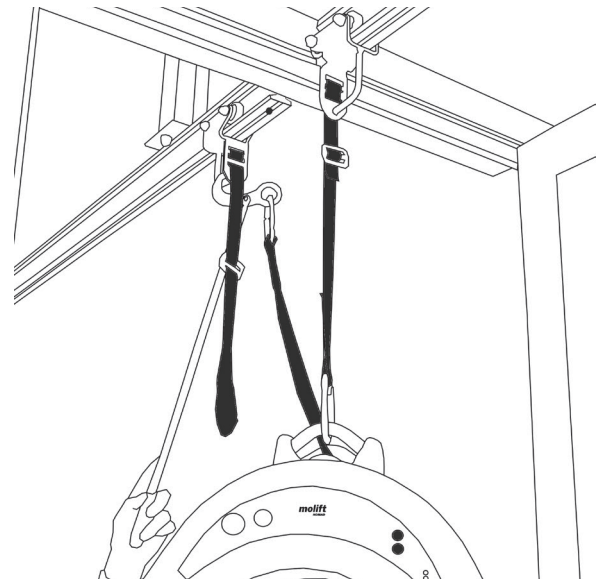

- Move the lifting belt to the opposite trolley with the attachment arm.
- Run the lifter up until it hangs in the lifting belt. The climbing belt can be released, and the lifter can be run up and down as normal.

Rail system

The rail system is mounted rigidly and may consist of several parts, like a traverse with transition coupling and switches.

Etac Supply Gjøvik has two different rail systems, one with open rails and a new system with closed rails which can be integrated in the ceiling (Molift Rail System, MRS).

If any damage or faults occur on the rail system, contact your local service representative/dealer or Etac Supply Gjøvik immediately.



Only one lifter is allowed to be mounted on each rail system at the same time. Make sure that the rail system has the same max. load as the lifter, 255 kg.



If the Molift NOMAD is mounted on a rail system with a lower lifting capacity, the lowest capacity also applies for the lifter.



Etac Supply Gjøvik has the system liability only when the rail system with lifting motor and suspension is mounted by authorized service representative/dealer or Etac Supply Gjøvik.

The Rail System with all parts is described in separate manuals (MRS handbook and Architect binder)

Trolley

There are several types of trolleys for Molift Nomad supplied to the rail system.

Trolleys MRS

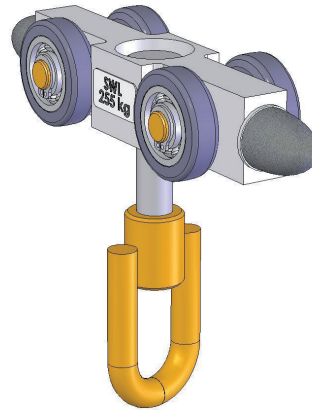

Trolley Molift Nomad (SWL 255 kg)

Part number 1109400

This is a standard trolley for Molift Nomad in MRS, with end bumpers and lifting eye with swivel function mounted.

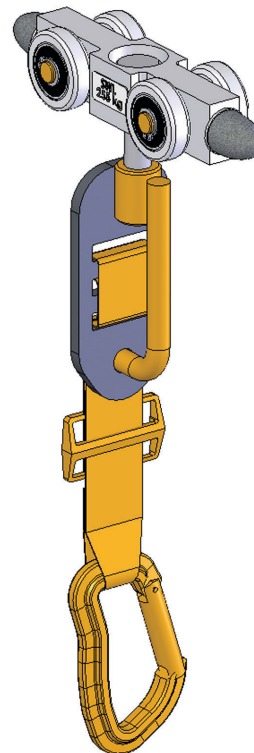

Trolley Molift Nomad Climbing (SWL 255 kg)

Part number 1109403

Trolley for Molift Nomad, with end bumpers, belt and lifting eyes prepared for climbing.

Trolley for Molift open rail

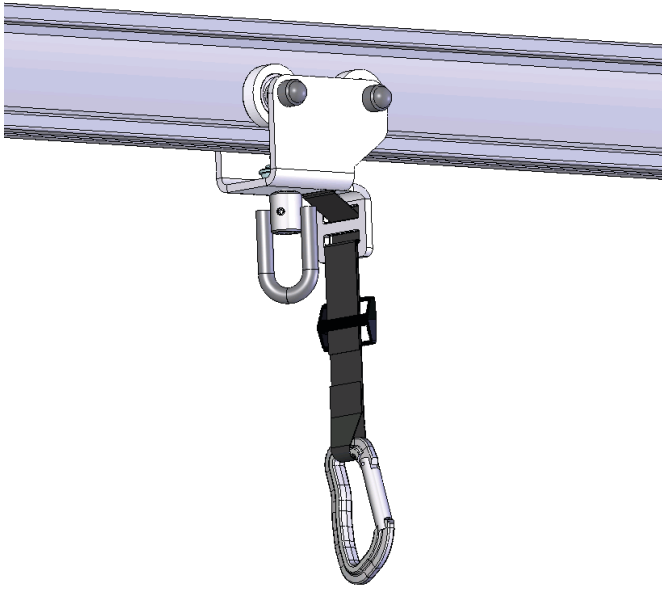

Trolley Molift Nomad

Part number 1210001

Trolley with swivel and a climbing belt that makes it possible to climb between two different rail systems.

When necessary it is possible to have a trolley with a suspended attachment hook.

Accessories

Lifting sling

Molift Easy Paediatric Sling

Size	No headsupport	With headsupport
XXS	Art. no 3005050	Art. no 3006050
XS	Art. no 3005000	Art. no 3006000

Easy Toilet Sling and Basic Bathing Sling for kids, see the tables below, size XXS and XS.

Molift Easy Sling

Size	No headsupport	With headsupport
XS	Art. no 3025000	Art. no 3026000
S	Art. no 3025100	Art. no 3026100
M	Art. no 3025200	Art. no 3026200
L	Art. no 3025300	Art. no 3026300
XL	Art. no 3025400	Art. no 3026400
XXL	Art. no 3025500	Art. no 3026500

Molift Basic Sling

Size	No headsupport	With headsupport
XXS	Art. no 3021050	Art. no 3022050
XS	Art. no 3021000	Art. no 3022000
S	Art. no 3021100	Art. no 3022100
M	Art. no 3021200	Art. no 3022200
L	Art. no 3021300	Art. no 3022300
XL	Art. no 3021400	Art. no 3022400
XXL	Art. no 3021500	Art. no 3022500

Molift Basic Bathing Sling

Size	No headsupport	With headsupport
XXS	Art. no 3023050	Art. no 3024050
XS	Art. no 3023000	Art. no 3024000
S	Art. no 3023100	Art. no 3024100
M	Art. no 3023200	Art. no 3024200
L	Art. no 3023300	Art. no 3024300
XL	Art. no 3023400	Art. no 3024400
XXL	Art. no 3023500	Art. no 3024500

Molift Easy Toilet Sling

Size	No headsupport	With headsupport
XXS	Art. no 3032050	Art. no 3033050
XS	Art. no 3032000	Art. no 3033000
S	Art. no 3032100	Art. no 3033100
M	Art. no 3032200	Art. no 3033200
L	Art. no 3032300	Art. no 3033300
XL	Art. no 3032400	Art. no 3033400
XXL	Art. no 3032500	Art. no 3033500

Molift Easy Toilet Sling Comfort

Size	No headsupport	Separate headsupport
XXS	Art. no 3016050	Art. no 3016055
XS	Art. no 3016000	Art. no 3016001
S	Art. no 3016100	Art. no 3016111
M	Art. no 3016200	Art. no 3016222
L	Art. no 3016300	Art. no 3016333
XL	Art. no 3016400	Art. no 3016444
XXL	Art. no 3016500	Art. no 3016555

Molift Easy Amputee Sling

Size	No headsupport	With headsupport
XXS	Art. no 3027050	Art. no 3028050
XS	Art. no 3027000	Art. no 3028000
S	Art. no 3027100	Art. no 3028100
M	Art. no 3027200	Art. no 3028200
L	Art. no 3027300	Art. no 3028300
XL	Art. no 3027400	Art. no 3028400
XXL	Art. no 3027500	Art. no 3028500

Molift Ambulating Vest

Size	No headsupport	Waist diameter
S	Art. no 303610	60-75 cm
M	Art. no 3036200	75-100 cm
L	Art. no 3036300	100-150 cm

Sling size guide

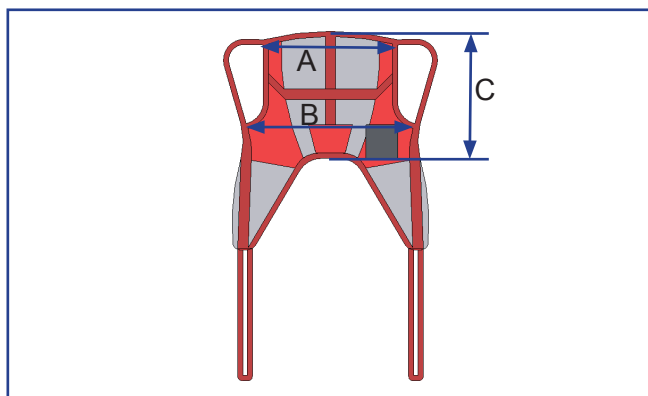

Easy and Basic Slings

Size	Color code	Recomm. weight (Kg)	A (cm)	B (cm)	C (cm)
XXL	White	230-300	86	130	68
XL	Blue	160-240	76	115	66
L	Green	90-160	66	100	64
M	Yellow	45-95	56	85	62
S	Red	25-50	51	75	60
XS	Light blue	17-25	46	65	58
XXS	Pink	12-17	41	55	56

Choice of sling size depends on both user weight and shape/size of user.

 Please see the user manual following each sling for specific user instructions.

Sling bag

Bag for slings - Art. no 3048000

Molift NOMAD Attachment arm

Extension Arm I 900 - Art. no 1200004

Extension Arm I 1050 - Art. no 1200006

Scale

Scale set - Art. no 1100235

Maintenance

Cleaning

 *Detergents must be pH-neutral. Do not use solvents or strong liquids - this may damage surfaces on the lifter. For disinfection when needed; use isopropyl alcohol. Avoid abrasive cleaning products.*

Clean surfaces with a damp cloth using an appropriate detergent.

Regular cleaning is recommended and should be implemented in the suitable cleaning routines.

Monthly maintenance

- Run the lifter through the complete installation, and check that it is running smoothly.
- Verify that the hand control contact is firmly in place. Clean contact and hand control with white spirit to remove grease and dirt.
- Check that the hand control cable has no damage.
- Check that the lifting belt has no damage, remove hair, dirt and dust from opening and check that the belt moves out and in easily throughout the length of the belt.
- Run lifter up and down to verify that it moves normally without any abnormal noise.
- Check that the battery and service light gives no signal. Contact local service representative/ dealer or Etac Supply Gjøvik if the lifter does not work properly or if the service light illuminates.

Periodic inspection

Molift recommends periodic inspection of the lifter once a year according to checklist on page 18. Periodic inspection is to be performed by authorized personnel. The rail system has a separate checklist for annually inspection.

One checklist is to be filled in and signed for each lifter after inspection. The owner of the lifter is responsible for keeping the list for information.

Troubleshooting

If you are not able to solve the fault or problems by yourself using this manual, please contact your local authorized service representative. If you don't know whom to contact locally, please contact your dealer or Etac Supply Gjøvik to get help.

Symptom	Possible cause/action
The lifter does not work	Battery discharged / charge <i>battery</i>
	Emergency stop is activated (pushed in) / <i>turn clockwise to reset</i>
	The cable/contact of the hand control has disconnected / <i>re-connect contact</i>
	Hand control has failed / <i>use operating buttons on lifter, switch hand control or contact local service representative for service</i>
	Lifting belt is untight / <i>tighten lifting belt, raise lifter</i>
	Defective control electronics / <i>contact local service representative for service</i>
Lifter moves slowly or makes noise	Lifter is defective / <i>contact local service representative for service</i>
	Brakes defective / <i>contact local service representative for service</i>
The lifter is not charging	Emergency stop is activated / <i>Reset emergency stop</i>
	Plug for charger is not connected to power (no light on charging light) / <i>Connect to power outlet</i>
	Hand control not placed correct in charger / <i>Check that the hand control is placed correct in the charger.</i>
	Connection between charger and hand control, or hand control and lifter, is bad / <i>Check and clean the contact points on the charger and hand control.</i>

Service

On the front right side of the lifter there is a service light which will give a signal when the lifter needs service. When there is a green light, the lifter can be used normally. If there is no light, push one of the up/down buttons to activate the electronics, and the service lamp will illuminate.

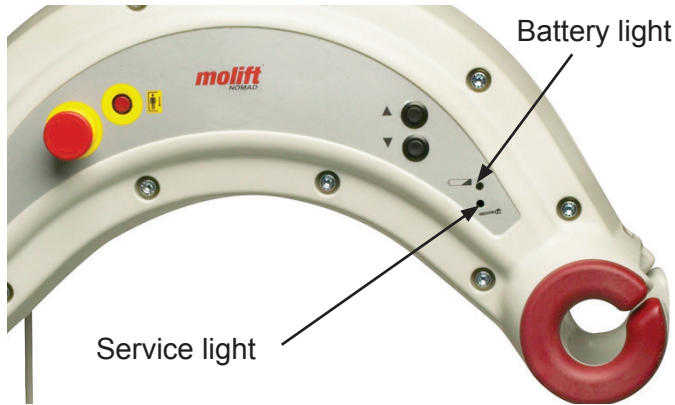

The electronics measures the operating time of the lifter, and after a specific time the yellow light will illuminate, indicating that the lifter needs service. Take contact with your local Molift service representative/dealer. The lifter can still be operated, but after a while an audible alarm will sound, to remind the operator that the lifter needs service immediately.

Service light codes

Service light	Mode
No light	Power saving
Green	Ready for use
Yellow	Book service
Red	Perform service
Red + sound	Perform service immediately
Flashing yellow	Overheating

Service is done according to procedures in the technical manual for the lifter.

Spare parts

A list of spare parts is available on request.

Labelling

Explanation of the lifters labelling:

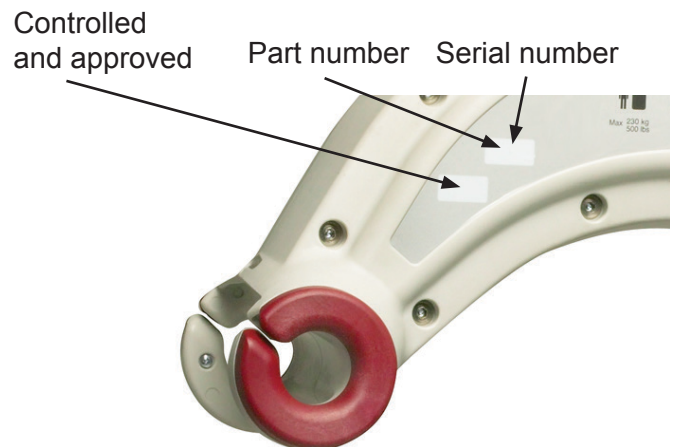

Type BF applied part



CE certified



Refer to user manual



Electrical Emergency lowering



Max user weight 255 kg



CSA certified



Do not dispose in general waste

Checklist for periodic inspection of Molift Nomad
Revision A – 10/2007

COMPULSORY SAFETY CHECK (annual):

OK	Fault	Corrected	Visual inspection
			Whole lifter checked for damage, cracks and deformation and found to be in good order. (Especially lifting hooks, lifting belt with hooks, screw piece and all cables).
			Lifter has been correctly assembled and has no loose parts.
			Accessories have been checked. See separate form for sling. Battery charger is an accessory. List the accessories checked:.....
			Function checks
			Emergency stop and manual control have been checked and are in working order.
			The lifter has been tested on the installation (preferably under load) and runs easily throughout the installation and the end stops are in order.
			The lifter has been fully raised and lowered (preferably under load) and moves evenly, stopping in the up and down positions by means of limit switches.
			Servicing required
			Servicing unnecessary because the servicing lamp is on green and the lifter is under 5 years old.

Completed	Compulsory in case of faults under one of the above points:
	The lifter has been removed from service and clearly marked "OUT OF ORDER" .
	Certified personnel have been summoned to carry out repairs and servicing. Name /Tel./ Fax:.....

Completed	Compulsory where lifter has been checked and approved:
	The lifter has passed the safety check and been affixed with the Molift safety check label, duly dated and signed.
	The ticked and signed checklist has been passed to the client.

Comments on faults and repairs:

.....

.....

.....

.....

.....

.....

.....

Lifter serial no.: Other ID. no. (if any):

Client:

Inspection carried out by: (Block capitals) from

Molift certification no. for inspector/repairer (if any):

The equipment has been tested and is in full working order Yes No

Place: Date: Signature:

**DECLARATION OF CONFORMITY****molift**[®]
by Etac

Etac AS, Etac Supply Gjøvik
Hadelandsveien 2
2816 Gjøvik
NORWAY
Telephone: + 47 4000 1004

hereby declare that:

Molift NOMAD patient lifter
and that the accessoires used only together with this product

are in conformity with:

- The Council Directive concerning medical devices 93/42/EEC
and according to this classified as **medical equipment class 1**
Expiration date : 30th May 2017

Molift NOMAD is manufactured in conformity with the following national or international standards that also might implement a harmonised standard:

- ISO10535:2006 Hoists for the transfer of disabled persons - Requirements and test methods
- ISO 14971:2007 Medical equipment - Risik analysis

Notified body:

Danish Technological Institute, Wood Technology
Gregersensvej 3
DK-2630 Taastrup
Denmark
Tel: + 45 7220 2301

NEMKO AS
Gaustadalleen 30
N-0314 OSLO
Norway
Tel: + 47 2296 0342

Title: Site Manager
Name: Knut Martin Frøsaker
Company: Etac AS, Etac Supply Gjøvik

30.05.2012

Date

Signature

Find your distributor
visit Molift.com

molift[®]
a part of Etac