



SUPINE TO PRONE
IN ONE MOTION

Zing

PRODUCT CATALOG

Zing

MPS, Supine, MPS TT(Tilt Table),
Supine TT(Tilt Table), Vertical, & Prone

The Zing

The Zing line of single and multi position standers were designed to fit the widest range of children and accommodate positioning challenges few other standers can. The Zing line features independent leg abduction up to 30 degrees on each model. The Zing can be configured with a simple padded strapping system to ease set up time in multi-user environments or when more individual positioning and support is required, additional components can be added to fit the users needs.



Zing MPS-Size 1

True Multi-Position Stander

- The MPS and MPS TT allow supine, vertical and prone positioning without flipping foot plates or pads, moving the tray or transferring out and back in the stander
- Smooth transition from a flat-to-load transfer position, supine, vertical and 20 degrees prone - all in one motion, thanks to the unique pivoting action of the Zing MPS and MPS TT
- Provides therapeutic opportunities not possible with other multi-position standers - use prone for head control and when fatigue sets in, simply move to a slight supine position to rest but remain in the standing position
- Frame will only go supine and upright with Prone Position Lockout engaged

True Hip Pivot Leg Abduction

- Pivot points are in line with the hips, promoting proper alignment in the hips, knees and feet
- Feet maintain the angle with the rest of the legs - no wedges needed and no additional adjustment to the knees or foot plates
- Up to 30 degrees of abduction per leg - accomplished through a single knob
- Promotes musculoskeletal development for children during critical growth years
- Abduction can be adjusted and used throughout the entire positioning range

Plenty of Growth

- **Size 1:** Fits children from infancy to 44", and up to 70lbs
- **Size 2:** Fits children from 40"-60", and up to 154lbs
- Can easily grow with the child and adapt to their changing needs
- Many supports, pads and straps are available in multiple sizes
- Comfortable transfer height of 32" makes transfers more manageable as children grow

Advantage

Remarkably Modular

- Can be configured as a simple stander or fit a child with the most complex needs
- Designed to grow with the child – options can be added as needed
- Great for a multi-user facility or school

Multi-Use Tray

- The MPS, Supine, MPS TT and Supine TT feature a multi-use tray that is angle adjustable and swings away either direction
- Tray can remain attached during transfers
- More activities are possible by swinging tray away during standing therapy

Unique Lift Mechanisms

- Dual controls are available allowing angle adjustment by foot pedal or hand control
- Gas Spring Lockout prevents an inadvertent change of position, especially important when around other children
- The Pow'r Up Lift option on Size 2 brings the user to the standing position with the touch of a button

Accommodating Contractures

- No special modifications are needed to accommodate children with contractures
- Using the multi-adjustable foot plates, multi-adjustable knee pads and the independent calf pads, it is possible to adjust for contractures in one or both sides

Easy Adjustment

- Tool-free adjustment of all components
- Every adjustment can be made with a simple turn of a knob or ratchet handle



Zing TT MPS-Size 2



Zing Prone-Size 1

Zing

MPS, Supine, MPS TT(Tilt Table),
Supine TT(Tilt Table), Vertical, & Prone

SUPINE TO PRONE

MPS Models Size 1 and Size 2



Supine Lying



Supine



Vertical



Prone



Zing Vertical-Size 1

Health Benefits

- Improve/maintain range of motion
- Decrease joint/muscle contractures
- Management of atrophy in the trunk and leg muscles
- Improve strength to trunk and lower extremities
- Decrease muscle spasms
- Promote proper muscle skeleton development
- Improve/maintain bone integrity/skeletal development
- Lessen/manage the progression of scoliosis
- Manage pressure (ulcers) through changing positions
- Improve bowel function and regularity
- Aid in kidney and bladder functions
- Strengthen cardiovascular system and build endurance
- Improve circulation
- Reduce swelling in lower extremities

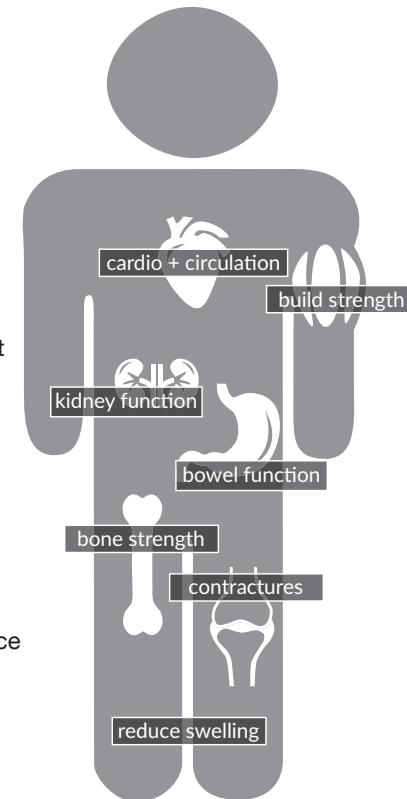

Hygienic Covers

- Available in 5 fun patterns for the pelvic, upper body, lateral, head and tray areas
- Prevents stander from getting soiled, especially during feeding
- Easily removed and washable



RAINBOW UNICORN



SEA CREATURES



FANCY PANTS ELEPHANTS



SPACE RACE



ALL SMILES ANIMALS

Frame Colors



GREEN



PURPLE

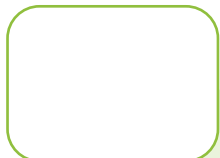

WHITE



ORANGE



Zing Prone-Size 1



Zing MPS-Size 1



Zing MPS TT

Zing-Size 1

MPS, Supine, MPS TT(Tilt Table),
Supine TT(Tilt Table), Vertical, & Prone

SIZE 1 SPECIFICATIONS

additional specifications at zingstanders.com



MPS (Multi-Position Stander)



Supine



MPS TT (Tilt Table)

The Zing MPS is the only multi-position stander that can seamlessly transition from supine to prone without having to transfer the child out and reposition foot plates, pads or trays.

The Zing Supine features a comfortable 32" transfer height and provides all the positioning and support features of the MPS, minus prone.

The Zing MPS TT is identical to the MPS from a positioning standpoint, but features larger, wider support pads and options for padded strapping, that can simplify transferring and securing children.

Weight Limit	70 lbs. (32kg)	70 lbs. (32kg)	70 lbs. (32kg)
Height Range*	up to 44" (112cm)	up to 44" (112cm)	up to 44" (112cm)
Transfer Height	32"(81cm)	32" (81cm)	32" (81cm)
Pelvic Support to Foot Plate Range	7"-22" (18-56cm)	7"-22" (18-56cm)	7"-22" (18-56cm)
Upper Body Support Height Range	4" (10cm)	4" (10cm)	4" (10cm)
Knee Pad Depth Range	5" (13cm)	5" (13cm)	5" (13cm)
Weight of Basic Unit	55 lbs (25kg)	55 lbs (25kg)	55 lbs (25kg)
Frame Footprint	20"x28" (51x71cm)	20"x28" (51x71cm)	20"x28" (51x71cm)
30° Independent Leg Abduction	Available	Available	Available
Supine	0-90°	0-90°	0-90°
Prone	0°-20°	n/a	0°-20°
HCPCS	E0641	E0638	E0641
Positions	Supine, Vertical, Prone	Supine, Vertical	Supine, Vertical, Prone
Tray	Adjustable, Swing-Away	Adjustable, Swing-Away	Adjustable, Swing-Away
Support	Individual Positioning Components, Padded Strapping	Individual Positioning Components, Padded Strapping	Individual Positioning Components, Padded Strapping
Dual Control	Available	Available	Available
Gas Spring Lockout	Available	Available	Available
Transfer Aid	Flat-to-Load	Flat-to-Load	Flat-to-Load
Tool Free Adjustment	Yes	Yes	Yes

*Height ranges are approximate, seat to footplate measurements are more accurate measurements to determine the correct size frame.



Zing MPS-Size 1



Supine TT (Tilt Table)



Vertical



Prone

The Zing Supine TT features the larger pads and padded strapping options of the MPS TT and positioning from flat to load supine to vertical.

The Zing Vertical is a single position stander that features a Padded Quick Strap to ease upright transfers. It's also one of the only vertical standers to offer anatomically correct independent leg abduction.

The Zing Prone is a single position stander but is one of the few to offer a flat-to-load transfer position at a comfortable height of 32". Prone positioning from 0-90 degrees.

70 lbs. (32kg)	70 lbs. (32kg)	70 lbs. (32kg)
up to 44" (112cm)	up to 44" (112cm)	up to 44" (112cm)
32" (81cm)	n/a	32" (81cm)
7"-22" (18-56cm)	7"-22" (18-56cm)	7"-22" (18-56cm)
4" (10cm)	4" (10cm)	4" (10cm)
5" (13cm)	5" (13cm)	5" (13cm)
55 lbs (25kg)	55 lbs (25kg)	55 lbs (25kg)
20"x28" (51x71cm)	20"x28" (51x71cm)	20"x28" (51x71cm)
Available	Available	Available
0-90°	n/a	n/a
n/a	n/a	0°-90°
E0638	E0638	E0638
Supine, Vertical	Vertical	Vertical, Prone
Adjustable, Swing-Away	Adjustable	Adjustable
Individual Positioning Components, Padded Strapping	Individual Positioning Components, Padded Strapping	Individual Positioning Components, Padded Strapping
Available	n/a	Available
Available	n/a	Available
Flat-to-Load	n/a	Flat-to-Load
Yes	Yes	Yes



Zing TT MPS-Size 1

FITTING THE ZING

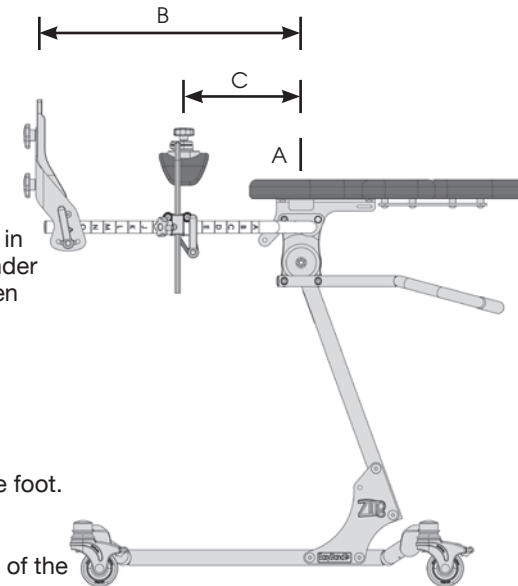

Centering the Hip (A):

The user's hip should be centered in line with the pivot point of the stander ensuring proper hip alignment when using abduction, adjust support components up or down based hip position.

Foot Plate Height (B):

Measure the distance from the hip of the user to the bottom of the foot.

Knee Pad Height (C):

Measure the distance from the hip of the user to center of the knee.

Zing MPS (Multi-Position Stander) Zing Supine

Size 1-Options

Size 1

up to 44"
(112cm)



The MPS (multi-position stander) base includes:

- Four Swivel Locking Casters
- Foot Operated Gas Spring
- Mast Receiver with Prone Position Lockout

The Supine base includes:

- Four Swivel Locking Casters
- Foot Operated Gas Spring
- Mast Receiver



**PA5520 Zing MPS Base
PA5522 Zing Supine Base**
Comes with four swivel locking casters, foot operated gas spring, mast receiver. MPS base comes with prone position lockout.



PA5530 Mast
Mast is the base for positioning options including foot plates, knee supports, pelvic supports, upper body supports and head supports.



PA5532 Mast with Leg Abduction
Mast is the base for support and positioning components and allows for 0-30° of independent leg abduction. Multi-adjustable knee pads or posterior knee pads and multi-adjustable foot plates required for leg abduction.



PA5612 Dual Control
Allows both foot and hand control of the gas spring lift. Push handle PA5594 required.



PA5614 Gas Spring Lift Lockout
Locks gas spring in any position from lying down to fully upright, supine and prone positions.



PA5608 Directional Locking Caster
Great for transporting stander. Directionally locks one caster while leaving the other three free to swivel.



PA5536 Platform Foot Plate
Adjustable in height. Foot holders and foot straps can be added for more precise positioning of the feet.



**PA5624, PA5626, PA5628
Multi-Adjustable Foot Plates**
Foot plates are adjustable forward/aft +/- .75" (2cm) +extra 1.5" (3.8cm), plantar/dorsi +/- 20°, toe-in/toe-out, swivel 30° left/right and in height. Foot holder sizes: PA5624-6"Lx3"W (15x8cm), PA5626-7.75"Lx3.25"W (20x8cm), PA5628-9.75"Lx4"W (25x10cm).



**PA5540, PA5542, PA5544
Foot Holders for Platform Foot Plate**
Use with the platform foot plate, gives added positioning of users feet. Foot holder sizes: PA5540-6"Lx3"W (15x8cm), PA5542-7.75"Lx3.25"W (20x8cm), PA5544-9.75"Lx4"W (25x10cm).



**PA5546 Secure Foot Straps-8"L
PT50082 Secure Foot Straps-10"L**
Velcro® and D-ring adjustment holds feet securely in place at ankles and toes with multiple attachment slots for proper foot positioning. Straps measured in length over top of foot, with approximately 1.5" (4cm) of Velcro® overlap.



**PA5548 Foot Straps-8"L
PT50080 Foot Straps-10"L**
Velcro® and D-ring adjustment holds feet in alignment with multiple attachment slots for proper foot positioning. Straps measured in length over top of foot, with approximately 1.5" (4cm) of Velcro® overlap.



PA5550 Calf/Knee Pad with Strap
4"x10" (10x25cm) pad attached to a 2" (5cm) Velcro® belt with a D-Ring closure, provides calf/knee stability for user. Fits circumference up to 24" (61cm). Gives support from the back of the calf/knee. Adjustable in height and fore/aft.



**PA5556, PA5558, PA5729, PA5730
Multi-Adjustable Knee Pads**
Multi-adjustable knee pads are adjustable in swivel, height +/- .75" (2cm), PA5556 inside width 2.5" (6cm), PA5558 inside width 3.25" (8cm), PA5729 inside width 4.25" (11cm) and PA5730 inside width 5" (13cm). With a depth range of 5" (13cm).



**PA5734 Posterior Knee Pads 3.5"
PA5736 Posterior Knee Pads 5"**
Provides anterior knee support with the strap and posterior knee support with the pad. PA5734 inside width is 3.5" (9cm) and PA5736 inside width is 5" (13cm). Not available with any other knee support options or calf pads.



**PA5560 Multi-Adjustable Calf Pads 3.5"
PA5678 Multi-Adjustable Calf Pads 4.5"**
Great for adapting to knee contractures. Gives support from the back of the calf. Adjustable in height with knee pad and fore/aft 4" (10cm) independently. Must order multi-adjustable knee pads.



PA5731 Knee Depth Stop
For multi-adjustable knee pads and posterior pads only.



**PA5562 Planar Pad-5"Hx7"W
PA5564 Planar Pad-5"Hx9"W**
Cushioned pad covered with Neoprene®. Pad sizes: PA5562-5"Hx7"W (13x18cm), PA5564-5"Hx9"W (13x23cm).



**PA5566 Form to Fit Pad-5"Hx10"W
PA5570 Form to Fit Pad-5"Hx12"W**
Form to fit pad can be custom fit to the user. Pad sizes: PA5566-5"Hx10"W (13x25cm) PA5570-5"Hx12"W (13x30cm). Not recommended with leg abduction mast.



PA5574 Hip Supports
Keeps the hips in symmetrical alignment. Adjustable from 6"-10" (15-25cm) with fore/aft 4" (10cm). Pad size is 3.5"x3.5" (9x9cm). For planar pads only.



PA3011 Pelvic Positioning Belt
2" (5cm) wide belt has a Velcro® belt with a D-Ring closure, provides hip stability for user. Fits circumference up to 24" (61cm).



PA5610 Pelvic Padded Positioning Strap
5"x8" (13x20cm) pad attached to a 2" (5cm) belt, Velcro® belt with a D-Ring closure. Fits circumference up to 24" (61cm).



PA3028, PA3029, PA3030, PA3032 Hygienic Covers
Washable slip on cover available in five different patterns. For planar pads PA5562 and PA5564 and form to fit pads PA5566 and PA5570.



PA5610 Upper Body Padded Positioning Strap
5"x8" (13x20cm) pad attached to a 2" (5cm) Velcro® belt with a D-Ring closure. Fits circumference up to 24" (61cm).



PA5602 Clear Swing Away Tray-11"Lx19"W
Swing-away tray is accessible in all positions and provides anterior support as user moves from supine to upright and prone positions. Adjustable in depth, height and tray angle. Tray size is 11"Lx19"W (28x48cm).



**PA5562 Planar Pad-5"Hx7"W
PA5564 Planar Pad-5"Hx9"W
PA5616 Planar Pad-7"Hx7"W
PA5618 Planar Pad-7"Hx9"W**
Cushioned pad covered with Neoprene®. Pad sizes: PA5562-5"Hx7"W (13x18cm), PA5564-5"Hx9"W (13x23cm), PA5616-7"Hx7"W (18x18cm), PA5618-7"Hx9"W (18x23cm).



PA3028, PA3029, PA3045, PA3046, PA3031, PA3033, PA3047, PA3048 Hygienic Covers
Washable slip on cover available in five different patterns. For planar pads PA5562, PA5564, PA5616, PA5618 and form to fit pads PA5568, PA5572, PA5620, PA5622.



PA5604 Forearm Wings-Black Molded Tray
Forearm wings give additional area to rest arms when in standing position.



**PA5568 Form to Fit Pad-5"Hx10"W
PA5620 Form to Fit Pad-7"Hx10"W
PA5572 Form to Fit Pad-5"Hx12"W
PA5622 Form to Fit Pad-7"Hx12"W**
Form to fit pad with built in lateral support that can be custom fit to the user. Pad size for PA5568-5"Hx10"W (13x25cm), PA5620-7"Hx10"W (18x25cm), PA5572-5"Hx12"W (13x30cm) and PA5622-7"Hx12"W (18x30cm).



PA3039 Hygienic Covers for Lateral Supports
Washable slip on cover available in five different patterns. For lateral supports PA5576.



PA5606 Forearm Wings-Clear Tray
Forearm wings give additional area to rest arms when in standing position.



PA5576 Lateral Supports
Keeps the upper torso in symmetrical alignment. Adjustable from 7-11" (18-28cm) with a 3.5" (9cm) height range. Pad size is 3.5"Hx3.5"W (9x9cm). For planar pads only.

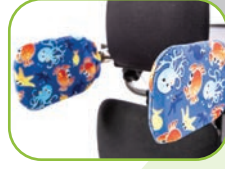

PB3049 Hygienic Covers for Lateral Supports
Washable slip on cover available in five different patterns. For lateral supports PA5743 and PA5744.



PA3038 Hygienic Padded Cover
Washable slip on cover is padded and available in five different patterns.



**PA5743 Lateral Supports with Flat Pads
PA5744 Lateral Supports with Curved Pads**
Keeps the upper torso in symmetrical alignment. Adjustable from 7-11" (18-28cm) with a 3.5" (9cm) height range. Pad size is 4"Hx6"W (10x15cm)-Curved Pad 4"Hx6.25"W (10x16cm)-Flat Pad. For planar pads only.



**PY5626 Head Support-5"Hx8"W
PY5628 Head Support-6"Hx10"W**
Cushion size is 5"Hx8"W (13x20cm), 6"Hx10"W (15x25cm). Depth range is -2.5" (6cm) to +1.5" (4cm) from backrest. Maximum height from top of upper body pad is 8" (20cm).



PNG50042 Hand Grips
Provides additional arm and hand support and alignment. Easily movable for precise arm positioning. Attaches with suction cups. Clear tray required.

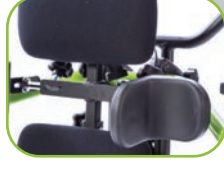

PA5578 Lateral Supports with Elbow Stop
Works as a lateral support and elbow rest. Great for the supine position. For planar pads only.



PA5586 Head Support-Form to Fit
Cushion size 5"Hx10"W (13x25cm). Depth range is -2.5" (6cm) to +1.5" (4cm) from backrest. Maximum height from top of upper body pad is 8" (20cm).



PA5594 Push Handle
Makes pushing the stander easier for the caregiver and also aids in lifting and lowering the child. Required for dual control.



PA5580 Lateral Supports w/Elbow Stop/Arm Rest
Works as a lateral support, elbow rest and armrest. Great for the supine, upright and prone position. For planar pads only. Height and width adjustable.



PA3035, PA3036, PA3037 Hygienic Covers
Washable slip on cover available in five different patterns. For PY5626, PY5628 and PA5586.



P80809 Tool Pouch
Holds the assembly tools provided with the stander. Attaches to unit with Velcro® straps.

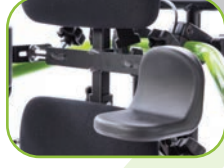

PA5630 Elbow Stop with Arm Rest
Great for loading and bringing to upright. Works with both planar and form to fit upper body supports. Height and width adjustable.



PA5596 Black Molded Tray-11"Lx19"W
Tray is accessible in all positions and provides anterior support as user moves from supine to upright and prone positions. Adjustable in depth and height. Tray size is 11"Lx19"W (28x48cm).



P80246 Angle Locator
Magnetic angle locator can be utilized for standing progress and leg abduction.



**PT50086 X-Style Chest Vest-9.5"Lx9"W
PT50088 X-Style Chest Vest-11"Lx9.5"W**
Neoprene® with camlock adjustment provides anterior trunk support for child.



PA5600 Black Molded Swing-Away Tray-11"Lx19"W
Swing-away tray is accessible in all positions and provides anterior support as user moves from supine to upright and prone positions. Adjustable in depth, height and tray angle. Tray size is 11"Lx19"W (28x48cm).

Zing MPS TT (Tilt Table)

Zing Supine TT (Tilt Table)

Size 1-Options

Size 1

up to 44"
(112cm)



The MPS (multi-position stander) TT base includes:

- Four Swivel Locking Casters
- Foot Operated Gas Spring
- Mast Receiver with Prone Position Lockout

The Supine TT base includes:

- Four Swivel Locking Casters
- Foot Operated Gas Spring
- Mast Receiver



PA5522 Zing Supine TT Base
PA5520 Zing MPS TT Base

Comes with four swivel locking casters, foot operated gas spring, mast receiver. MPS base comes with prone position lockout.



PA5632 Mast

Mast is the base for support and positioning components.



PA5634 Mast with Leg Abduction

Mast is the base for support and positioning components and allows for 0-30° of independent leg abduction. Multi-adjustable knee pads, leg supports, or posterior knee pads and multi-adjustable foot plates required for leg abduction.



PA5612 Dual Control

Allows both foot and hand control of the gas spring lift. Push handle PA5594 required.



PA5614 Gas Spring Lift Lockout

Locks gas spring in any position from lying down to fully upright, supine and prone positions.



PA5608 Directional Locking Caster

Great for transporting stander. Directionally locks one caster while leaving the other three free to swivel.



PA5536 Platform Foot Plate

Adjustable in height. Foot holders and foot straps can be added for more precise positioning of the feet.



PA5624, PA5626, PA5628
Multi-Adjustable Foot Plates

Foot plates are adjustable forward/aft +/- .75" (2cm) +extra 1.5" (3.8cm), plantar/dorsi +/- 20°, toe-in/toe-out, swivel 30° left/right and in height. Foot holder sizes: PA5624-6"Lx3"W (15x8cm), PA5626-7.75"Lx3.25"W (20x8cm), PA5628-9.75"Lx4"W (25x10cm).



PA5540, PA5542, PA5544
Foot Holders for Platform Foot Plate

Use with the platform foot plate, gives added positioning of users feet. Foot holder sizes: PA5540-6"Lx3"W (15x8cm), PA5542-7.75"Lx3.25"W (20x8cm), PA5544-9.75"Lx4"W (25x10cm).



PA5546 Secure Foot Straps-8"L
PT50082 Secure Foot Straps-10"L

Velcro® and D-ring adjustment holds feet securely in place at ankles and toes with multiple attachment slots for proper foot positioning. Straps measured in length over top of foot, with approximately 1.5" (4cm) of Velcro® overlap.



PA5548 Foot Straps-8"L
PT50080 Foot Straps-10"L

Velcro® and D-ring adjustment holds feet in alignment with multiple attachment slots for proper foot positioning. Straps measured in length over top of foot, with approximately 1.5" (4cm) of Velcro® overlap.



PA5644, PA5646, PA5648
Leg Support Planar Pads

Cushioned Neoprene® pad for leg support. Pad sizes: PA5644-4"Hx6"W (10x15cm) PA5646-6"Hx6"W (15x15cm) PA5648-8"Hx6"W (20x15cm)



PA5660, PA5662, PA5664 Hygienic Covers

Washable slip on cover available in five different patterns. For planar pads PA5644, PA5646, PA5648.



PA5550 Calf/Knee Pad with Strap

4"x10" (10x25cm) pad attached to a 2" (5cm) Velcro® belt with a D-Ring closure, provides calf/knee stability for user. Fits circumference up to 24" (61cm). Gives support from the back of the calf/knee. Adjustable in height and fore/aft.



PA5666, PA5668, PA5670 Knee Strap

4"x6" (10x15cm) pad attached to a 2" (5cm) Velcro® belt with a D-Ring closure. Fits circumference up to 15" (38cm). Adjustable in height. For leg supports PA5644, PA5646, PA5648.



PA5556, PA5558, PA5729, PA5730
Multi-Adjustable Knee Pads

Multi-adjustable knee pads are adjustable in swivel, height +/- .75" (2cm), PA5556 inside width 2.5" (6cm), PA5558 inside width 3.25" (8cm), PA5729 inside width 4.25" (11cm) and PA5730 inside width 5" (13cm). With a depth range of 5" (13cm).



PA5734 Posterior Knee Pads 3.5"
PA5736 Posterior Knee Pads 5"

Provides anterior knee support with the strap and posterior knee support with the pad. PA5734 inside width is 3.5" (9cm) and PS5736 inside width is 5" (13cm). Not available with any other knee support options or calf pads.



PA5560 Multi-Adjustable Calf Pads 3.5"
PA5678 Multi-Adjustable Calf Pads 4.5"

Great for adapting to knee contractures. Gives support from the back of the calf. Adjustable in height with knee pad and fore/aft -1"-4" (-2.5-10cm) independently. Must order multi-adjustable knee pads.



PA5731 Knee Depth Stop

For multi-adjustable knee pads and posterior pads only.



PA5638, PA5640, PA5642 Planar Pad

Cushioned pad covered with Neoprene®. Pad sizes: PA5638-14"Hx14"W (36x36cm) PA5640-16"Hx14"W (41x36cm) PA5642-18"Hx14"W (46x36cm)

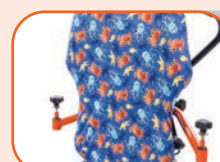

PA3063, PA3064, PA3065 Hygienic Covers

Washable slip on cover available in five different patterns. For planar pads PA5638, PA5640, PA5642.

**PA5636 Hip Supports**

Keeps the hips in symmetrical alignment. Adjustable from 6"-10" (15-25cm) with fore/aft 4" (10cm). Pad size is 3.5"x3.5" (9x9cm).

**PB3049 Hygienic Covers for Lateral Supports**

Washable slip on cover available in five different patterns. For lateral supports PA5745, PA5746, PA5747 and PA5748.

**PA5604 Forearm Wings-Black Molded Tray**

Forearm wings give additional area to rest arms when in standing position.

**PA3062 Pelvic Positioning Strap**

2" (5cm) wide belt has a Velcro® belt with a D-Ring closure, provides hip stability for user. Fits circumference up to 24" (61cm).

**PA5650 Head Support-Planar Pad**

Cushioned Neoprene® pad for head support. Pad size 8"Hx8.5"W (21x22cm).

**PA5606 Forearm Wings-Clear Tray**

Forearm wings give additional area to rest arms when in standing position.

**PA5672 Pelvic Padded Positioning Strap**

5"x8" (13x20cm) pad attached to a 2" (5cm) belt. Fits circumference up to 24" (61cm).

**PY5626 Head Support-5"Hx8"W
PY5628 Head Support-6"Hx10"W**

Cushion size is 5"Hx8"W (13x20cm), 6"Hx10"W (15x25cm). Depth range is -2.5" (6cm) to +1.5" (4cm) from backrest. Maximum height from top of upper body pad is 8" (20cm).

**PA3038 Hygienic Padded Tray Cover**

Washable slip on cover for tray is padded and available in five different patterns.

**PA5652 Lateral Supports-4"-8" Range Square Pads
PA5654 Lateral Supports-7"-11" Range Square Pads**

Keeps the upper torso in symmetrical alignment. PA5652 Adjustable from 4"-8" (10-20cm), PA5654 Adjustable from 7"-11" (18-28cm) with a 3.5" (9cm) height range. Pad size is 3.5"Hx3.5"W (9x9cm).

**PA5586 Head Support-Form to Fit**

Cushion size 5"Hx10"W (13x25cm). Depth range is -2.5" (6cm) to +1.5" (4cm) from backrest. Maximum height from top of upper body pad is 8" (20cm).

**PNG50042 Hand Grips**

Provides additional arm and hand support and alignment. Easily movable for precise arm positioning. Attaches with suction cups. Clear tray required.

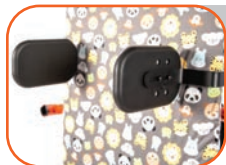
**PA5745 Lateral Supports-4"-8" Range Flat Pads
PA5746 Lateral Supports-7"-11" Range Flat Pads**

Keeps the upper torso in symmetrical alignment. PA5745 Adjustable from 4"-8" (10-20cm), PA5746 Adjustable from 7"-11" (18-28cm) with a 3.5" (9cm) height range. Pad size 4"Hx6.25"W (10x16cm).

**PA5676 Headrest Mounting Bracket**

For use of alternative manufacturer's head supports.

**PA5594 Push Handle**

Makes pushing the stander easier for the caregiver and also aids in lifting and lowering the child. Required for dual control.

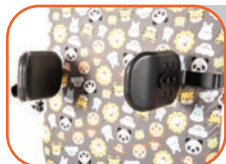
**PA5747 Lateral Supports-4"-8" Range Curved Pads
PA5748 Lateral Supports-7"-11" Range Curved Pads**

Keeps the upper torso in symmetrical alignment. PA5747 Adjustable from 4"-8" (10-20cm), PA5748 Adjustable from 7"-11" (18-28cm) with a 3.5" (9cm) height range. Pad size 4"Hx6"W (10x15cm).

**PA3066, PA3035, PA3036, PA3037
Hygienic Covers**

Washable slip on cover available in five different patterns. For head supports PA5650, PY5626, PY5628, PA5586.

**P80809 Tool Pouch**

Holds the assembly tools provided with the stander. Attaches to unit with Velcro® straps.

**PA5674 Upper Body Padded Positioning Strap**

5"x8" (13x20cm) pad attached to a 2" (5cm) Velcro® belt with a D-Ring closure. Fits circumference up to 24" (61cm).

**PA5596 Black Molded Tray-11"Lx19"W**

Tray is accessible in all positions and provides anterior support as user moves from supine to upright and prone positions. Adjustable in depth and height. Tray size is 11"Lx19"W (28x48cm).

**P80246 Angle Locator**

Magnetic angle locator can be utilized for standing progress and leg abduction.

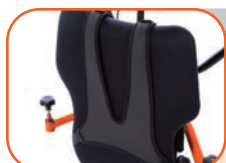
**PT50086 X-Style Chest Vest-9.5"Lx9"W
PT50088 X-Style Chest Vest-11"Lx9.5"W**

Neoprene® with camlock adjustment provides anterior trunk support for child.

**PA5600 Black Molded Swing-Away Tray-11"Lx19"W**

Swing-away tray is accessible in all positions and provides anterior support as user moves from supine to upright and prone positions. Adjustable in depth, height and tray angle. Tray size is 11"Lx19"W (28x48cm).

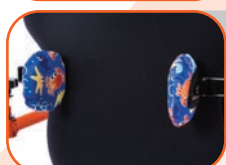
**PA3039 Hygienic Covers for Lateral Supports**

Washable slip on cover available in five different patterns. For lateral supports PA5652 and PA5654.

**PA5602 Clear Swing Away Tray-11"Lx19"W**

Swing-away tray is accessible in all positions and provides anterior support as user moves from supine to upright and prone positions. Adjustable in depth, height and tray angle. Tray size is 11"Lx19"W (28x48cm).

Zing Vertical

Size 1-Options

Size 1

up to 44"
(112cm)



The Vertical base includes:

- Four Swivel Locking Casters
- Mast Receiver



PA5524 Zing Vertical Base

Comes with four swivel locking casters and a mast receiver.



PA5530 Mast

Mast is the base for support and positioning components.



PA5532 Mast with Leg Abduction

Mast is the base for support and positioning components and allows for 0-30° of independent leg abduction. Multi-adjustable knee pads or posterior knee pads and multi-adjustable foot plates required for leg abduction.



PA5608 Directional Locking Caster

Great for transporting stander. Directionally locks one caster while leaving the other three free to swivel.



PA5680 Platform Foot Plate

Adjustable in height. Foot holders and foot straps can be added for more precise positioning of the feet.



PA5624, PA5626, PA5628 Multi-Adjustable Foot Plates

Foot plates are adjustable forward/aft +/- .75" (2cm) +extra 1.5" (3.8cm), plantar/dorsal +/- 20°, toe-in/toe-out, swivel 30° left/right and in height. Foot holder sizes: PA5624-6"Lx3"W (15x8cm), PA5626-7.75"Lx3.25"W (20x8cm), PA5628-9.75"Lx4"W (25x10cm).



PA5540, PA5542, PA5544 Foot Holders for Platform Foot Plate

Use with the platform foot plate, gives added positioning of users feet. Foot holder sizes: PA5540-6"Lx3"W (15x8cm), PA5542-7.75"Lx3.25"W (20x8cm), PA5544-9.75"Lx4"W (25x10cm).



**PA5546 Secure Foot Straps-8"L
PT50082 Secure Foot Straps-10"L**

Velcro® and D-ring adjustment holds feet securely in place at ankles and toes with multiple attachment slots for proper foot positioning. Straps measured in length over top of foot, with approximately 1.5" (4cm) of Velcro® overlap.



**PA5548 Foot Straps-8"L
PT50080 Foot Straps-10"L**

Velcro® and D-ring adjustment holds feet in alignment with multiple attachment slots for proper foot positioning. Straps measured in length over top of foot, with approximately 1.5" (4cm) of Velcro® overlap.



PA5550 Calf/Knee Pad with Strap

4"x10" (10x25cm) pad attached to a 2" (5cm) Velcro® belt with a D-Ring closure, provides calf/knee stability for user. Fits circumference up to 24" (61cm). Gives support from the back of the calf/knee. Adjustable in height and fore/aft.



PA5688, PA5690, PA5727, PA5728 Multi-Adjustable Knee Pads

Multi-adjustable knee pads are adjustable in swivel, height +/- .75" (2cm), PA5688 inside width 2.5" (6cm), PA5690 inside width 3.25" (8cm), PA5727 inside width 4.25" (11cm) and PA5728 inside width 5" (13cm). With a depth range of 5" (13cm).



PA5726 Knee Strap

4"x6" (10x15cm) pad attached to a 2" (5cm) Velcro® belt with a D-Ring closure. Fits circumference up to 15" (38cm). Adjustable in height. For PA5688, PA5690, PA5727 and PA5728.



PA5731 Knee Depth Stop

For multi-adjustable knee pads only.



**PA5562 Planar Pad-5"Hx7"W
PA5564 Planar Pad-5"Hx9"W**

Cushioned pad covered with Neoprene®. Pad sizes: PA5562-5"Hx7"W (13x18cm), PA5564-5"Hx9"W (13x23cm).



**PA5566 Form to Fit Pad-5"Hx10"W
PA5570 Form to Fit Pad-5"Hx12"W**

Form to fit pad can be custom fit to the user. Pad sizes: PA5566-5"Hx10"W (13x25cm) PA5570-5"Hx12"W (13x30cm).



PA5574 Hip Supports

Keeps the hips in symmetrical alignment. Adjustable from 6"-10" (15-25cm) with fore/aft 4" (10cm). Pad size is 3.5"x3.5" (9x9cm). For planar pads only.



PA3011 Pelvic Positioning Strap

2" (5cm) wide belt has a Velcro® belt with a D-Ring closure, provides hip stability for user. Fits circumference up to 24" (61cm).



PA5610 Pelvic Padded Positioning Strap

5"x8" (13x20cm) pad attached to a 2" (5cm) Velcro® belt with a D-Ring closure. Fits circumference up to 24" (61cm).



PA3092 Quick Strap

2" (5cm) wide belt has a airline style buckle for quick closure, provides hip stability for user. Fits circumference up to 24" (61cm).



PA3093 Padded Quick Strap

5"x8" (13x20cm) pad attached to a 2" (5cm) belt has a airline style buckle for quick closure. Fits circumference up to 24" (61cm).



PA3028, PA3029, PA3045, PA3046 Hygienic Cover

Washable slip on cover available in five different patterns. For planar pads PA5562, PA5564, PA5616, PA5618.

**PA3030, PA3032 Hygienic Cover**

Washable slip on cover available in five different patterns. For form to fit pads PA5566 and PA5570.

**PA3039 Hygienic Covers for Lateral Supports**

Washable slip on cover available in five different patterns. For lateral supports PA5702 and PA5704.

**PA5718 Multi-Adjustable Clear Tray-11"Lx19"W**

Tray provides anterior support. Adjustable in depth, height and tray angle. Tray size is 11"Lx19"W (28x48cm).

**PA5692, PA5562, PA5564, PA5616, PA5618 Planar Pad**

Cushioned pad covered with Neoprene®. Pad sizes:
PA5692-5"Hx5"W (13x13cm)
PA5562-5"Hx7"W (13x18cm)
PA5564-5"Hx9"W (13x21cm)
PA5616-7"Hx7"W (18x18cm)
PA5618-7"Hx9"W (18x21cm)

**PB3049 Hygienic Covers for Lateral Supports**

Washable slip on cover available in five different patterns. For lateral supports PA5749, PA5750, PA5751 and PA5752.

**PA5604 Forearm Wings-Black Molded Tray**

Forearm wings give additional area to rest arms when in standing position.

**PA5566 Form to Fit Pad-5"Hx10"W
PA5570 Form to Fit Pad-5"Hx12"W**

Form to fit pad with built in lateral support that can be custom fit to the user. Pad sizes are: PA5566-5"Hx10"W (13x25cm), PA5570-5"Hx12"W (13x30cm).

**PA3084, PA3028, PA3029, PA3045, PA3046 Hygienic Cover**

Washable slip on cover available in five different patterns. For planar pads PA5692, PA5562, PA5564, PA5616 and PA5618.

**PA5606 Forearm Wings-Clear Tray**

Forearm wings give additional area to rest arms when in standing position.

**PA5694 Form to Fit Pad-5"Hx10"W
PA5696 Form to Fit Pad-5"Hx12"W**

Form to fit pad with extra sternum positioning. Built in lateral support that can be custom fit to the user. Pad sizes are: PA5694-5"Hx10"W (13x25cm), PA5696-5"Hx12"W (13x30cm).

**PA3030, PA3032 Hygienic Cover**

Washable slip on cover available in five different patterns. For form to fit pads PA5566 and PA5570.

**PA3038 Hygienic Padded Cover**

Washable slip on cover for tray is padded and available in five different patterns.

**PA5698 Form to Fit Pad-7"Hx10"W
PA5700 Form to Fit Pad-7"Hx12"W**

Form to fit pad with extra sternum positioning. Built in lateral support that can be custom fit to the user. Pad sizes are: PA5698-7"Hx10"W (18x25cm), PA5700-7"Hx12"W (18x30cm).

**PA3085, PA3086, PA3087, PA3088 Hygienic Cover**

Washable slip on cover available in five different patterns. For form to fit pads PA5694, PA5696, PA5698 and PA5700.

**PNG50042 Hand Grips**

Provides additional arm and hand support and alignment. Easily movable for precise arm positioning. Attaches with suction cups. Clear tray required.

**PA5702 Lateral Supports-4"-8" Range Square Pads
PA5704 Lateral Supports-7"-11" Range Square Pads**

Keeps the upper torso in symmetrical alignment. PA5702 Adjustable from 4"-8" (10-20cm), PA5704 Adjustable from 7"-11" (18-28cm) with a 3.5" (9cm) height range. Pad size is 3.5"Hx3.5"W (9x9cm). For planar pads only.

**PA5706 Face Aperture-5"H
PA5708 Face Aperture-7"H**

Pad size is 9"Hx3"W (23x8cm). With a 5" (13cm) or 7" (18cm) range from the upper body support, individual face aperture pads are adjustable. Supports the head.

**PA5720 Push Handle for Tray**

Makes pushing the stander easier for the caregiver.

**PA5749 Lateral Supports-4"-8" Range Flat Pads
PA5750 Lateral Supports-7"-11" Range Flat Pads**

Keeps the upper torso in symmetrical alignment. PA5749 Adjustable from 4"-8" (10-20cm), PA5750 Adjustable from 7"-11" (18-28cm) with a 3.5" (9cm) height range. Pad size 4"Hx6.25"W (10x16cm).

**PA5710 Hygienic Cover**

Washable slip on cover available in five different patterns. For face apertures PA5706 and PA5708.

**P80809 Tool Pouch**

Holds the assembly tools provided with the stander. Attaches to unit with Velcro® straps.

**PA5751 Lateral Supports-4"-8" Range Curved Pads
PA5752 Lateral Supports-7"-11" Range Curved Pad**

Keeps the upper torso in symmetrical alignment. PA5751 Adjustable from 4"-8" (10-20cm), PA5752 Adjustable from 7"-11" (18-28cm) with a 3.5" (9cm) height range. Pad size 4"Hx6"W (10x15cm).

**PA5712 Black Molded Tray-11"Lx19"W**

Tray provides anterior support. Adjustable in depth and height. Tray size is 11"Lx19"W (28x48cm).

**P80246 Angle Locator**

Magnetic angle locator can be utilized for leg abduction.



PA5610 Upper Body Padded Positioning Strap
5"x8" (13x20cm) pad attached to a 2" (5cm) Velcro® belt with a D-Ring closure. Fits circumference up to 24" (61cm).

**PA5716 Multi-Adjustable Black Molded Tray-11"Lx19"W**

Tray provides anterior support. Adjustable in depth, height and tray angle. Tray size is 11"Lx19"W (28x48cm).

Zing Prone

Size 1-Options

Size 1

up to 44"
(112cm)



The Prone base includes:

- Four Swivel Locking Casters
- Foot Operated Gas Spring
- Mast Receiver



PA5522 Zing Prone Base

Comes with four swivel locking casters, foot operated gas spring and a mast receiver.



PA5530 Mast

Mast is the base for support and positioning components.



PA5532 Mast with Leg Abduction

Mast is the base for support and positioning components and allows for 0-30° of independent leg abduction. Multi-adjustable knee pads and multi-adjustable foot plates required for leg abduction.



PA5725 Dual Control

Allows both foot and hand control of the gas spring lift. Push handle PA5720 required.



PA5614 Gas Spring Lift Lockout

Locks gas spring in any position from lying down to fully upright and supine positions.



PA5608 Directional Locking Caster

Great for transporting stander. Directionally locks one caster while leaving the other three free to swivel.



PA5680 Platform Foot Plate

Adjustable in height. Foot holders and foot straps can be added for more precise positioning of the feet.



PA5624, PA5626, PA5628 Multi-Adjustable Foot Plates

Foot plates are adjustable forward/aft +/- .75" (2cm) +extra 1.5" (3.8cm), plantar/dorsi +/- 20°, toe-in/toe-out, swivel 30° left/right and in height. Foot holder sizes: PA5624-6"Lx3"W (15x8cm), PA5626-7.75"Lx3.25"W (20x8cm), PA5628-9.75"Lx4"W (25x10cm).



PA5540, PA5542, PA5544 Foot Holders for Platform Foot Plate

Use with the platform foot plate, gives added positioning of users feet. Foot holder sizes: PA5540-6"Lx3"W (15x8cm), PA5542-7.75"Lx3.25"W (20x8cm), PA5544-9.75"Lx4"W (25x10cm).



PA5546 Secure Foot Straps-8"L PT50082 Secure Foot Straps-10"L

Velcro® and D-ring adjustment holds feet securely in place at ankles and toes with multiple attachment slots for proper foot positioning. Straps measured in length over top of foot, with approximately 1.5" (4cm) of Velcro® overlap.



PA5548 Foot Straps-8"L PT50080 Foot Straps-10"L

Velcro® and D-ring adjustment holds feet in alignment with multiple attachment slots for proper foot positioning. Straps measured in length over top of foot, with approximately 1.5" (4cm) of Velcro® overlap.



PA5550 Calf/Knee Pad with Strap

4"x10" (10x25cm) pad attached to a 2" (5cm) Velcro® belt with a D-Ring closure, provides calf/knee stability for user. Fits circumference up to 24" (61cm). Gives support from the back of the calf/knee. Adjustable in height and fore/aft.



PA5688 PA5690, PA5727, PA5728 Multi-Adjustable Knee Pads

Multi-adjustable knee pads are adjustable in swivel, height +/- .75" (2cm), PA5688 inside width 2.5" (6cm), PA5690 inside width 3.25" (8cm), PA5727 inside width 4.25" (11cm) and PA5728 inside width 5" (13cm). With a depth range of 5" (13cm).



PA5726 Knee Strap

4"x6" (10x15cm) pad attached to a 2" (5cm) Velcro® belt with a D-Ring closure. Fits circumference up to 15" (38cm). Adjustable in height. For PA5688, PA5690, PA5727 and PA5728.



PA5731 Knee Depth Stop

For multi-adjustable knee pads only.



PA5562 Planar Pad-5"Hx7"W PA5564 Planar Pad-5"Hx9"W

Cushioned pad covered with Neoprene®. Pad sizes: PA5562-5"Hx7"W (13x18cm), PA5564-5"Hx9"W (13x23cm).



PA5566 Form to Fit Pad-5"Hx10"W PA5570 Form to Fit Pad-5"Hx12"W

Form to fit pad can be custom fit to the user. Pad sizes: PA5566-5"Hx10"W (13x25cm) PA5570-5"Hx12"W (13x30cm).



PA5574 Hip Supports

Keeps the hips in symmetrical alignment. Adjustable from 6"-10" (15-25cm) with fore/aft 4" (10cm). Pad size is 3.5"x3.5" (9x9cm). For planar pads only.



PA3011 Pelvic Positioning Strap

2" (5cm) wide belt has a Velcro® belt with a D-Ring closure, provides hip stability for user. Fits circumference up to 24" (61cm).



PA5610 Pelvic Padded Positioning Strap

5"x8" (13x20cm) pad attached to a 2" (5cm) Velcro® belt with a D-Ring closure. Fits circumference up to 24" (61cm).



PA3092 Quick Strap

2" (5cm) wide belt has a airline style buckle for quick closure, provides hip stability for user. Fits circumference up to 24" (61cm).

**PA3093 Padded Quick Strap**

5"x8" (13x20cm) pad attached to a 2" (5cm) belt has a airline style buckle for quick closure. Fits circumference up to 24" (61cm).

**PA5610 Upper Body Padded Positioning Strap**

5"x8" (13x20cm) pad attached to a 2" (5cm) Velcro® belt with a D-Ring closure. Fits circumference up to 24" (61cm).

**PA5716 Multi-Adjustable Black Molded Tray-11"Lx19"W**

Tray provides anterior support. Adjustable in depth, height and tray angle. Tray size is 11"Lx19"W (28x48cm).

**PA3028, PA3029, PA3045, PA3046 Hygienic Cover**

Washable slip on cover available in five different patterns. For planar pads PA5562, PA5564, PA5616, PA5618.

**PA3039 Hygienic Cover for Lateral Supports**

Washable slip on cover available in five different patterns. For lateral supports PA5702 and PA5704.

**PA5718 Multi-Adjustable Clear Tray-11"Lx19"W**

Tray provides anterior support. Adjustable in depth, height and tray angle. Tray size is 11"Lx19"W (28x48cm).

**PA3030, PA3032 Hygienic Cover**

Washable slip on cover available in five different patterns. For form to fit pads PA5566 and PA5570.

**PB3049 Hygienic Cover for Lateral Supports**

Washable slip on cover available in five different patterns. For lateral supports PA5749, PA5750, PA5751 and PA5752.

**PA5604 Forearm Wings-Black Molded Tray
PA5606 Forearm Wings-Clear Tray**

Forearm wings give additional area to rest arms when in standing position.

**PA5692, PA5562, PA5564, PA5616, PA5618 Planar Pad**

Cushioned pad covered with Neoprene®. Pad sizes:
PA5692-5"Hx5"W (13x13cm)
PA5562-5"Hx7"W (13x18cm)
PA5564-5"Hx9"W (13x21cm)
PA5616-7"Hx7"W (18x18cm)
PA5618-7"Hx9"W (18x21cm)

**PA3084, PA3028, PA3029, PA3045, PA3046 Hygienic Cover**

Washable slip on cover available in five different patterns. For planar pads PA5692, PA5562, PA5564, PA5616, and PA5618.

**PA3038 Hygienic Padded Cover**

Washable slip on cover for tray is padded and available in five different patterns.

**PA5566 Form to Fit Pad-5"Hx10"W
PA5570 Form to Fit Pad-5"Hx12"W**

Form to fit pad with extra sternum positioning. Built in lateral support that can be custom fit to the user. Pad sizes are: PA5566 5"Hx10"W (13x25cm), PA5570 5"Hx12"W (13x30cm).

**PA3030, PA3032 Hygienic Cover**

Washable slip on cover available in five different patterns. For form to fit pads PA5566 and PA5570.

**PNG50042 Hand Grips**

Provides additional arm and hand support and alignment. Easily movable for precise arm positioning. Attaches with suction cups. Clear tray required.

**PA5694 Form to Fit Pad-5"Hx10"W
PA5696 Form to Fit Pad-5"Hx12"W
PA5698 Form to Fit Pad-7"Hx10"W
PA5700 Form to Fit Pad-7"Hx12"W**

Form to fit pad with extra sternum positioning. Built in lateral support that can be custom fit to the user. Pad sizes are: PA5694-5"Hx10"W (13x25cm), PA5696-5"Hx12"W (13x30cm), PA5698-7"Hx10"W (18x25cm), PA5700-7"Hx12"W (18x30cm).

**PA3085, PA3086, PA3087, PA3088 Hygienic Cover**

Washable slip on cover available in five different patterns. For form to fit pads PA5694, PA5696, PA5698 and PA5700.

**PA5720 Push Handle for Tray**

Makes pushing the stander easier for the caregiver and also aids in lifting and lowering the child. Required for dual control. Not available with PA5712.

**PA5749 Lateral Supports-4"-8" Range Flat Pads
PA5750 Lateral Supports-7"-11" Range Flat Pads**

Keeps the upper torso in symmetrical alignment. PA5702 Adjustable from 4"-8" (10-20cm), PA5704 Adjustable from 7"-11" (18-28cm) with a 3.5" (9cm) height range. Pad size is 3.5"Hx3.5"W (9x9cm). For planar pads only.

**PA5706 Face Aperture-5"H
PA5708 Face Aperture-7"H**

Pad size is 9"Hx3"W (23x8cm). With a 5" (13cm) or 7" (18cm) range from the upper body support, individual face aperture pads are adjustable. Supports the head.

**P80809 Tool Pouch**

Holds the assembly tools provided with the stander. Attaches to unit with Velcro® straps.

**PA5749 Lateral Supports-4"-8" Range Flat Pads
PA5750 Lateral Supports-7"-11" Range Flat Pads**

Keeps the upper torso in symmetrical alignment. PA5749 Adjustable from 4"-8" (10-20cm), PA5750 Adjustable from 7"-11" (18-28cm) with a 3.5" (9cm) height range. Pad size 4"Hx6.25"W (10x16cm).

**PA5710 Hygienic Cover**

Washable slip on cover available in five different patterns. For face apertures PA5706 and PA5708.

**P80246 Angle Locator**

Magnetic angle locator can be utilized for standing progress and leg abduction.

**PA5751 Lateral Supports-4"-8" Range Curved Pads
PA5752 Lateral Supports-7"-11" Range Curved Pad**

Keeps the upper torso in symmetrical alignment. PA5751 Adjustable from 4"-8" (10-20cm), PA5752 Adjustable from 7"-11" (18-28cm) with a 3.5" (9cm) height range. Pad size 4"Hx6"W (10x15cm).

**PA5712 Black Molded Tray-11"Lx19"W**

Tray provides anterior support. Adjustable in depth and height. Tray size is 11"Lx19"W (28x48cm).

Zing-Size 2



MPS, Supine, MPS TT(Tilt Table),
Supine TT(Tilt Table), & Prone

SIZE 2 SPECIFICATIONS

additional specifications at zingstanders.com



Zing MPS-Size 2

	 MPS (Multi-Position Stander)	 Supine	 MPS TT (Tilt Table)
	The Zing MPS is the only multi-position stander that can seamlessly transition from supine to prone without having to transfer the child out and reposition foot plates, pads or trays.	The Zing Supine features a comfortable 31" transfer height and provides all the positioning and support features of the MPS, minus prone.	The Zing MPS TT is identical to the MPS from a positioning standpoint, but features larger, wider support pads and options for padded strapping, that can simplify transferring and securing children.
Weight Limit	154 lbs. (70kg)	154 lbs. (70kg)	154 lbs. (70kg)
Height Range*	40"-60" (102-152cm)	40"-60" (102-152cm)	40"-60" (102-152cm)
Transfer Height	31" (79cm)	31" (79cm)	31" (79cm)
Hip to Foot Plate Range	34" (86cm)	34" (86cm)	34" (86cm)
Upper Body Support Height Range	6" (15cm)	6" (15cm)	6" (15cm)
Knee Pad Depth Range	7" (18cm)	7" (18cm)	7" (18cm)
Weight of Basic Unit	82 lbs (37kg)	82 lbs (37kg)	82 lbs (37kg)
Frame Footprint	26.75"x39.75" (68x101cm)	26.75"x39.75" (68x101cm)	26.75"x39.75" (68x101cm)
30° Independent Leg Abduction	Available	Available	Available
Supine	0-90°	0-90°	0-90°
Prone	0°-20°	n/a	0°-20°
HPCPS	E0641	E0638	E0641
Positions	Supine, Vertical, Prone	Supine, Vertical	Supine, Vertical, Prone
Tray	Adjustable, Swing-Away	Adjustable, Swing-Away	Adjustable, Swing-Away
Support	Individual Positioning Components, Padded Strapping	Individual Positioning Components, Padded Strapping	Individual Positioning Components, Padded Strapping
Dual Control	Available	Available	Available
Gas Spring Lockout	Available	Available	Available
Transfer Aid	Flat-to-Load	Flat-to-Load	Flat-to-Load
Tool Free Adjustment	Yes	Yes	Yes
Pow'r Up Lift Option	Yes	Yes	Yes

*Height ranges are approximate, seat to footplate measurements are more accurate measurements to determine the correct size frame.



Supine TT (Tilt Table)



Prone

The Zing Supine TT features the larger pads and padded strapping options of the MPS TT and positioning from flat to load supine to vertical.

The Zing Prone is a single position stander but is one of the few to offer a flat-to-load transfer position at a comfortable height of 31". Prone positioning from 0-90 degrees.

154 lbs. (70kg)	154 lbs. (70kg)
40"-60" (102-152cm)	40"-60" (102-152cm)
31" (79cm)	31" (79cm)
34" (86cm)	34" (86cm)
6" (15cm)	6" (15cm)
7" (18cm)	7" (18cm)
82 lbs (37kg)	82 lbs (37kg)
26.75"x39.75" (68x101cm)	26.75"x39.75" (68x101cm)
Available	Available
0-90°	n/a
n/a	0°-90°
E0638	E0638
Supine, Vertical	Vertical, Prone
Adjustable, Swing-Away	Adjustable
Individual Positioning Components, Padded Strapping	Individual Positioning Components, Padded Strapping
Available	Available
Available	Available
Flat-to-Load	Flat-to-Load
Yes	Yes
Yes	Yes



Zing Prone-Size 2

FITTING THE ZING

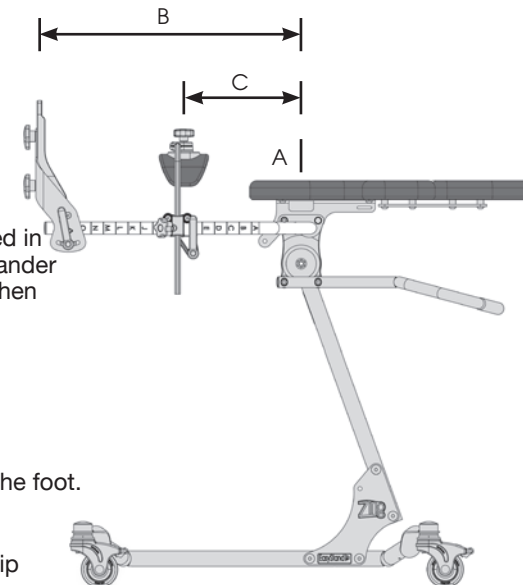

Centering the Hip (A):

The user's hip should be centered in line with the pivot point of the stander ensuring proper hip alignment when using abduction, adjust support components up or down based hip position.

Foot Plate Height (B):

Measure the distance from the hip of the user to the bottom of the foot.

Knee Pad Height (C):

Measure the distance from the hip of the user to center of the knee.

Zing MPS (Multi-Position Stander) Zing Supine

Size 2-Options

Size 2

40"-60"
(102-152cm)



154 lbs
(70 kg)

The MPS (multi-position stander) base includes:

- Four Swivel Locking Casters
- Foot Operated Gas Spring or Pow'r Up Lift
- Mast Receiver with Prone Position Lockout

The Supine base includes:

- Four Swivel Locking Casters
- Foot Operated Gas Spring or Pow'r Up Lift
- Mast Receiver



PB5500 Zing MPS Base Gas Spring Lift
PB5502 Zing Supine Base Gas Spring Lift
Comes with four swivel locking casters, foot operated gas spring, mast receiver. MPS base comes with prone position lockout.



PB5504 Zing MPS Base Pow'r Up Lift
PB5506 Zing Supine Base Pow'r Up Lift
Comes with four swivel locking casters, Pow'r Up Lift, mast receiver. MPS base comes with prone position lockout.



PB5512 Mast
Mast is the base for positioning options including foot plates, knee supports, pelvic supports, upper body supports and head supports.



PB5514 Mast with Leg Abduction
Mast is the base for support and positioning components and allows for 0-30° of independent leg abduction. Multi-adjustable knee pads or posterior knee pads and multi-adjustable foot plates required for leg abduction.



PB5516 Dual Control
Allows both foot and hand control of the gas spring lift. Push handle PB5560 required.



PA5614 Gas Spring Lift Lockout
Locks gas spring in any position from lying down to fully upright, supine and prone positions.



PB5510 Directional Locking Caster
Great for transporting stander. Directionally locks one caster while leaving the other three free to swivel.



PB5518 Platform Foot Plate
Adjustable in height. Foot holders and foot straps can be added for more precise positioning of the feet. Platform 16.75"Wx11.5"L (29-43cm).



PB5520, PB5522, PB5524 Multi-Adjustable Foot Plates
Foot plates are adjustable forward/aft +/- .75" (2cm) +extra 1.5" (3.8cm), plantar/dorsi +/- 20°, toe-in/toe-out, swivel 30° left/right and in height. Foot holder sizes: PB5520 7.75"Lx3.25"W (20x8cm), PB5522 9.75"Lx4"W (25x10cm), PB5524 11.75"Lx5"W (30x13cm).



PA5542, PA5544, PB5526 Foot Holders for Platform Foot Plate
Use with the platform foot plate, provides added positioning of users feet. Foot holder sizes: PA5542 7.75"Lx3.25"W (20x8cm), PA5544 9.75"Lx4"W (25x10cm), PB5526 11.75"Lx5"W (30x13cm).



PT50082 Secure Foot Straps-10"L
PY5638 Secure Foot Straps-15"L
PNG50506 Secure Foot Straps-21"L
Velcro® and D-ring adjustment holds feet securely in place at ankles and toes with multiple attachment slots for proper foot positioning. Straps measured in length over top of foot, with approximately 1.5" (4cm) of Velcro® overlap.



PT50080 Foot Straps-10"L
PY5636 Foot Straps-15"L
PNG50505 Foot Straps-21"L
Velcro® and D-ring adjustment holds feet in alignment with multiple attachment slots for proper foot positioning. Straps measured in length over top of foot, with approximately 1.5" (4cm) of Velcro® overlap.



PB5528 Calf/Knee Pad with Strap
17.5"x5.5" (44x14cm) pad attached to a 2" (5cm) Velcro® belt with a D-Ring closure, provides calf/knee stability for user. Fits circumference up to 28"-38" (71-97cm). Gives support from the back of the calf/knee. Adjustable in height and fore/aft.



PB5530, PB5532, PB5534 Multi-Adjustable Knee Pads
Multi-adjustable knee pads are adjustable in swivel, height +/- .75" (2cm), PA5530 inside width 3.25" (8cm), PA5532 inside width 4.25" (11cm) and PB5534 inside width 5" (13cm). With a depth range of 7" (18cm).



PB5646 Posterior Knee Pads 5"
PB5648 Posterior Knee Pads 7"
PB5650 Posterior Knee Pads 8"
Provides anterior knee support with the strap and posterior knee support with the pad. PB5646 inside width is 5" (13cm), PB5648 inside width is 7" (17cm) and PB5650 inside width is 8" (20cm). Not available with any other knee support options or calf pads.



PA5678 Multi-Adjustable Calf Pads 4.5"
PB5536 Multi-Adjustable Calf Pads 5.5"
Great for adapting to knee contractures. Gives support from the back of the calf. Adjustable in height with knee pad and fore/aft +3"/-2" (+8cm/-5cm) independently. Must order multi-adjustable knee pads.



PA5731 Knee Depth Stop
For multi-adjustable knee pads and posterior pads only.



PB3000 Planar Pad 10"Hx11"W
PB3002 Planar Pad 10"Hx13"W
Cushioned pad covered with Neoprene®. Pad sizes: PB3000-10"Hx11"W (25x28cm) PB3002-10"Hx13"W (25x33cm)



PB3004 Form to Fit Pad 10"Hx11"W
PB3006 Form to Fit Pad 10"Hx13"W
Form to fit pad can be custom fit to the user. Pad sizes: PB3004 10"Hx11"W (25x28cm) PB3006 10"Hx13"W (25x33cm). Not recommended with leg abduction mast.



PB5538, PB5540 Hip Supports
Keeps the hips in symmetrical alignment. Adjustable from PB5538 7"-13" (18-33cm) and PB5540 12"-18" (30-46cm) with fore/aft 4" (10cm). Pad size is 4.5"x4" (11x10cm). For planar pads only.



PT30066 Pelvic Positioning Strap
2" (5cm) wide belt has a Velcro® belt with a D-Ring closure, provides hip stability for user. Fits circumference up to 35" (89cm).



PB5542 Pelvic Padded Positioning Strap
6"x10" (15x25cm) pad attached to a 2" (5cm) Velcro® belt with a D-Ring closure. Fits circumference up to 35" (89cm).



PB5552 Elbow Stop with Arm Rest
Great for loading and bringing to upright. For planar pads only. Height and width adjustable.



PB5556 Black Molded Swing-Away Tray-21"Lx24"W
Swing-away tray is accessible in all positions and provides anterior support as user moves from supine to upright and prone positions. Adjustable in depth, height and tray angle. Tray size is 21"Lx24"W (53x61cm).



PB3025, PB3026 Hygienic Cover
Washable slip on cover available in five different patterns. For planar pads PB3000 and PB3002.



PNG30170 X-Style Chest Vest-11"Lx9.5"W
PNG30056 X-Style Chest Vest-14.5"Lx10.5"W
PNG30171 Y-Style Chest Vest-17.5"Lx11.5"W
PNG30021 Y-Style Chest Vest-20.5"Lx12.5"W
Neoprene® with camlock adjustment provides anterior trunk support for child.



PB5558 Clear Swing Away Tray-21"Lx24"W
Swing-away tray is accessible in all positions and provides anterior support as user moves from supine to upright and prone positions. Adjustable in depth, height and tray angle. Tray size is 21"Lx24"W (53x61cm).



PB3027, PB3028 Hygienic Cover
Washable slip on cover available in five different patterns. For form to fit pads PB3004 and PB3006.



PB5542 Upper Body Padded Positioning Strap
6"x10" (15x25cm) pad attached to a 2" (5cm) Velcro® belt with a D-Ring closure. Fits circumference up to 35" (89cm).



PT50156 Elbow Pad-9.25" Cutout
PT50160 Elbow Pad-11" Cutout
PY5582 Elbow Pad-13" Cutout
Additional padded support surface on the black molded or clear tray. 9.25" (24cm), 11" (28cm) and 13" (33cm) cutout width. Overall width 21.5" (55cm), pad extends back 3.75" (10cm) posterior from current table edge for additional upper body/extremity support.



PB3053 Planar Pad-8"Hx8"W
PB3001 Planar Pad-8"Hx11"W
PB3003 Planar Pad-8"Hx13"W
Cushioned pad covered with Neoprene®. Pad size for PB3053 is 8"Hx8"W (20x20cm). Pad size for PB3001 is 8"Hx11"W (20x28cm) and PB3003 is 8"Hx13"W (20x33cm).



PB3054, PB3029, PB3030 Hygienic Cover
PB3031, PB3032 Hygienic Covers
Washable slip on cover available in five different patterns. For planar pads PB3053, PB3001 and PB3003 and form to fit pads PB3005 and PB3007.



PNG30295 Hygienic Padded Cover
Washable slip on cover is padded and available in five different patterns.



PB3005 Form to Fit Pad-8"Hx11"W
PB3007 Form to Fit Pad-8"Hx13"W
Form to fit pad with built in lateral support that can be custom fit to the user. Pad size for PB3005 is 8"Hx11"W (20x28cm) and PB3007 is 8"Hx13"W (20x33cm).



PB3049 Hygienic Cover for Lateral Supports
Washable slip on cover available in five different patterns. For PB5653, PB5654, PB5544 and PB5546. Not available with elbow stop or arm rest.



PNG50042 Hand Grips
Provides additional arm and hand support and alignment. Easily movable for precise arm positioning. Attaches with suction cups. Clear tray required.



PB5653 Lateral Supports Flat Pads
PB5654 Lateral Supports Flat Pads
Keeps the upper torso in symmetrical alignment. For planar pads only. Adjustable Range: PB5653 5"-7.25"W with PB3053, 7"-11"W with PB3001 and 9"-13"W PB3003. PB5654 8"-10.25"W with PB3053, 10"-14"W PB3001 and 12"-16"W PB3003 with a 3.5" (9cm) height range. Pad size is 4"Hx6"W (10x15cm).



PY5626 Head Support 5"Hx8"W
PY5628 Head Support 6"Hx10"W
PY5630 Head Support 7"Hx14"W
Cushion sizes are: PY5626 5"Hx8"W (13x20cm), PY5628 6"Hx10"W (15x25cm), PY5630 7"Hx14"W (18x36cm). Depth range is +1" to -2.75" (+2 to -7cm) from backrest. Maximum height from top of upper body pad is 10" (25cm).



PB5560 Push Handle
Makes pushing the stander easier for the caregiver and also aids in lifting and lowering the child. Required for dual control.



PB5544 Lateral Supports with Curved Pads
PB5546 Lateral Supports with Curved Pads
Keeps the upper torso in symmetrical alignment. For planar pads only. Adjustable Range: PB5544 5"-7.25"W with PB3053, 7"-11"W with PB3001 and 9"-13"W PB3003. PB5546 8"-10.25"W with PB3053, 10"-14"W PB3001 and 12"-16"W PB3003 with a 3.5" (9cm) height range. Pad size is 4"Hx6.25"W (10x16cm).



PA5586 Head Support-Form to Fit
Cushion size 5"Hx10"W (13x25cm). Depth range is -2.5" (6cm) to +1.5" (4cm) from backrest. Maximum height from top of upper body pad is 10" (25cm).



P80809 Tool Pouch
Holds the assembly tools provided with the stander. Attaches to unit with Velcro® straps.



PB5548 Lateral Supports with Elbow Stop
PB5639 Lateral Supports with Elbow Stop
Works as a lateral support and elbow rest. Great for the supine position. Range: 7"-11" (18-28cm) with planar pad B3053 10"-17" (25-43cm) with planar pad B3001 and 12"-19" (30-48cm) with planar pad B3003. For planar pads only.



PA3035, PA3036, PB3033, PA3037 Hygienic Cover
Washable slip on cover available in five different patterns. For PY5626, PY5628, PY5630 and PA5586.



P80246 Angle Locator
Magnetic angle locator can be utilized for standing progress and leg abduction.



PB5550 Lateral Supports w/Elbow Stop/Arm Rest
Works as a lateral support, elbow rest and armrest. Great for the supine, upright and prone position. For planar pads only. Height and width adjustable.



PB5554 Black Molded Tray-21"Lx24"W
Tray is accessible in all positions and provides anterior support as user moves from supine to upright and prone positions. Adjustable in depth and height. Tray size is 21"Lx24"W (53x61cm).

Zing MPS TT (Tilt Table)

Zing Supine TT (Tilt Table)

Size 2-Options

Size 2
40"-60"
(102-152cm)



154 lbs
(70 kg)

The MPS (multi-position stander) TT base includes:

- Four Swivel Locking Casters
- Foot Operated Gas Spring or Pow'r Up Lift
- Mast Receiver with Prone Position Lockout

The Supine TT base includes:

- Four Swivel Locking Casters
- Foot Operated Gas Spring or Pow'r Up Lift
- Mast Receiver



PB5562 Zing MPS TT Base Gas Spring Lift
PB5564 Zing Supine TT Base Gas Spring Lift
Comes with four swivel locking casters, foot operated gas spring, mast receiver. MPS base comes with prone position lockout.



PB5566 Zing MPS TT Base Pow'r Up Lift
PB5568 Zing Supine TT Base Pow'r Up Lift
Comes with four swivel locking casters, Pow'r Up Lift, mast receiver. MPS base comes with prone position lockout.



PB5512 Mast
Mast is the base for positioning options including foot plates, knee supports, pelvic supports, upper body supports and head supports.



PB5514 Mast with Leg Abduction
Mast is the base for support and positioning components and allows for 0-30° of independent leg abduction. Multi-adjustable knee pads, leg supports or posterior knee pads and multi-adjustable foot plates required for leg abduction.



PB5516 Dual Control
Allows both foot and hand control of the gas spring lift. Push handle PB5560 required.



PA5614 Gas Spring Lift Lockout
Locks gas spring in any position from lying down to fully upright, supine and prone positions.



PB5510 Directional Locking Caster
Great for transporting stander. Directionally locks one caster while leaving the other three free to swivel.



PB5518 Platform Foot Plate
Adjustable in height. Foot holders and foot straps can be added for more precise positioning of the feet.



PB5520, PB5522, PB5524 Multi-Adjustable Foot Plates
Foot plates are adjustable forward/aft +/- .75" (2cm) +extra 1.5" (3.8cm), plantar/dorsi +/- 20°, toe-in/toe-out, swivel 30° left/right and in height. Foot holder sizes: PB5520 7.75"Lx3.25"W (20x8cm), PB5522 9.75"Lx4"W (25x10cm), PB5524 11.75"Lx5"W (30x13cm).



PA5542, PA5544, PB5526 Foot Holders for Platform Foot Plate
Use with the platform foot plate, gives added positioning of users feet. Foot holder sizes: PA5542 7.75"Lx3.25"W (20x8cm), PA5544 9.75"Lx4"W (25x10cm), PB5526 11.75"Lx5"W (30x13cm).



PT50082 Secure Foot Straps-10"L
PY5638 Secure Foot Straps-15"L
PNG50506 Secure Foot Straps-21"L
Velcro® and D-ring adjustment holds feet securely in place at ankles and toes with multiple attachment slots for proper foot positioning. Straps measured in length over top of foot, with approximately 1.5" (4cm) of Velcro® overlap.



PT50080 Foot Straps-10"L
PY5636 Foot Straps-15"L
PNG50505 Foot Straps-21"L
Velcro® and D-ring adjustment holds feet in alignment with multiple attachment slots for proper foot positioning. Straps measured in length over top of foot, with approximately 1.5" (4cm) of Velcro® overlap.



PB5570, PB5572, PB5574 Leg Support Planar Pads
Cushioned Neoprene® pad for leg support. Pad sizes:
PB5570- 9"Hx7.5"W (19x23cm)
PB5572-12"Hx7.5"W (19x30cm)
PB5574-15"Hx7.5"W (19x38cm)



PB5600, PB5602, PB5604 Hygienic Covers
Washable slip on cover available in five different patterns. For planar pads PB5570, PB5572, PB5574.



PB5528 Calf/Knee Pad with Strap
17.5"x5.5" (44x14cm) pad attached to a 2" (5cm) Velcro® belt with a D-Ring closure, provides calf/knee stability for user. Fits circumference up to 28"-38" (71-97cm). Gives support from the back of the calf/knee. Adjustable in height and fore/aft.



PB5576, PB5578, PB5580 Knee Strap
4"x6" (10x15cm) pad attached to a 2" (5cm) Velcro® belt with a D-Ring closure. Fits circumference up to 19" (48cm). Adjustable in height. For leg supports PB5570, PB5572, PB5574.



PB5530, PB5532, PB5534 Multi-Adjustable Knee Pads
Multi-adjustable knee pads are adjustable in swivel, height +/- .75" (2cm), PA5530 inside width 3.25" (8cm), PA5532 inside width 4.25" (11cm) and PB5534 inside width 5" (13cm). With a depth range of 7" (18cm).



PB5646 Posterior Knee Pads 5"
PB5648 Posterior Knee Pads 7"
PB5650 Posterior Knee Pads 8"
Provides anterior knee support with the strap and posterior knee support with the pad. PB5646 inside width is 5" (13cm), PB5648 inside width is 7" (17cm) and PB5650 inside width is 8" (20cm). Not available with any other knee support options or calf pads.



PA5678 Multi-Adjustable Calf Pads 4.5"
PB5536 Multi-Adjustable Calf Pads 5.5"
Great for adapting to knee contractures. Gives support from the back of the calf. Adjustable in height with knee pad and fore/aft 4" (10cm) independently. Must order multi-adjustable knee pads.



PA5731 Knee Depth Stop
For multi-adjustable knee pads and posterior pads only.



PB3012, PB3015, PB3018 Planar Pad
Cushioned pad covered with Neoprene®. Pad sizes:
PB3012-19"Hx16"W (48x41cm)
PB3015-22"Hx16"W (56x41cm)
PB3018-25"Hx16"W (64x41cm)



PB3035, PB3036, PB3037 Hygienic Cover
Washable slip on cover available in five different patterns. For planar pads PB3012, PB3015, PB3018.



PB3049 Hygienic Cover
Washable slip on cover available in five different patterns. For PB5588 and PB5599.



PB5558 Clear Swing Away Tray-21"Lx24"W
Swing-away tray is accessible in all positions and provides anterior support as user moves from supine to upright and prone positions. Adjustable in depth, height and tray angle. Tray size is 21"Lx24"W (53x61cm).



PB5584, PB5586 Hip Supports
Keeps the hips in symmetrical alignment. Adjustable from PB5538 7"-13" (18-33cm) and PB5540 10"-16" (25-41cm) with fore/aft 4" (10cm). Pad size is 4.5"x4" (11x10cm).



PB5582 Head Support Planar Pad
Cushioned Neoprene® pad for head support. Pad size 9"Hx10"W (23x25cm).



PT50156 Elbow Pad-9.25" Cutout
Additional padded support surface on the black molded or clear tray. 9.25" (24cm) cutout width. Overall width 21.5" (55cm), pad extends back 3.75" (10cm) posterior from current table edge for additional upper body/extremity support.



**PA3062 Pelvic Positioning Strap
PB3052 Pelvic Positioning Strap**
2" (5cm) wide belt has a Velcro® belt with a D-Ring closure, provides hip stability for user. Fits circumference up to PA3011 45" (114cm) and PB3052 57" (145cm).



**PY5626 Head Support 5"Hx8"W
PY5628 Head Support 6"Hx10"W
PY5630 Head Support 7"Hx14"W**
Cushion sizes are: PY5626-5"Hx8"W (13x20cm), PY5628-6"Hx10"W (15x25cm), PY5630-7"Hx14"W (18x36cm). Depth range is +1" to -2.75" (+2 to -7cm) from backrest. Maximum height from top of upper body pad is 10" (25cm).



PT50160 Elbow Pad-11" Cutout
Additional padded support surface on the black molded or clear tray. 11" (28cm) cutout width. Overall width 21.5" (55cm), pad extends back 3.75" (10cm) posterior from current table edge for additional upper body/extremity support.



**PB5592 Pelvic Padded Positioning Strap
PB5594 Pelvic Padded Positioning Strap**
6"x10" (15x25cm) pad attached to a 2" (5cm) Velcro® belt with a D-Ring closure. Fits circumference up to PB5592 45" (114cm) and PB5594 57" (145cm).



PA5586 Head Support-Form to Fit
Cushion size 5"Hx10"W (13x25cm). Depth range is -2.5" (6cm) to +1.5" (4cm) from backrest. Maximum height from top of upper body pad is 10" (25cm).



PY5582 Elbow Pad-13" Cutout
Additional padded support surface on the black molded or clear tray. 13" (33cm) cutout width. Overall width 21.5" (55cm), pad extends back 3.75" (10cm) posterior from current table edge for additional upper body/extremity support.



**PB5655 Lateral Supports-7"-11" Range Flat Pads
PB5656 Lateral Supports-10"-16" Range Flat Pads**
Keeps the upper torso in symmetrical alignment. Adjustable from PB5655 7-11" (18-28cm) and PB5656 10-16" (25-41cm) with a 3.5" (9cm) height range. Pad size is 4"Hx6"W (10x15cm). For planar pads only.



PB3038 Hygienic Cover for Head Support Planar Pad
Washable slip on cover available in five different patterns. For PB5582.



PNG30295 Hygienic Padded Cover
Washable slip on cover is padded and available in five different patterns.



**PB5588 Lateral Supports-7"-11" Range Curved Pads
PB5590 Lateral Supports-10"-16" Range Curved Pads**
Keeps the upper torso in symmetrical alignment. Adjustable from PB5655 7-11" (18-28cm) and PB5656 10-16" (25-41cm) with a 3.5" (9cm) height range. Pad size is 4"Hx6.25"W (10x16cm). For planar pads only.



PA3035, PA3036, PB3033 Hygienic Covers
Washable slip on cover available in five different patterns. For PY5626, PY5628 and PY5630.



PNG50042 Hand Grips
Provides additional arm and hand support and alignment. Easily movable for precise arm positioning. Attaches with suction cups. Clear tray required.



**PNG30170 X-Style Chest Vest-11"Lx9.5"W
PNG30056 X-Style Chest Vest-14.5"Lx10.5"W**
Neoprene® with camlock adjustment provides anterior trunk support for child.



PA3037 Hygienic Cover
Washable slip on cover available in five different patterns. For PA5586.



PB5560 Push Handle
Makes pushing the stander easier for the caregiver and also aids in lifting and lowering the child. Required for dual control.



**PNG30171 Y-Style Chest Vest-17.5"Lx11.5"W
PNG30021 Y-Style Chest Vest-20.5"Lx12.5"W**
Neoprene® with camlock adjustment provides anterior trunk support for child.

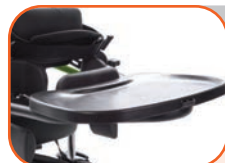

PB5554 Black Molded Tray-21"Lx24"W
Tray is accessible in all positions and provides anterior support as user moves from supine to upright and prone positions. Adjustable in depth and height. Tray size is 21"Lx24"W (53x61cm).



P80809 Tool Pouch
Holds the assembly tools provided with the stander. Attaches to unit with Velcro® straps.

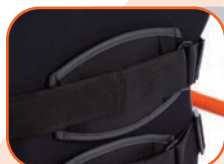

**PB5596 Upper Body Padded Positioning Strap
PB5598 Upper Body Padded Positioning Strap**
6"x10" (15x25cm) pad attached to a 2" (5cm) Velcro® belt with a D-Ring closure. Fits circumference up to PB5596 45" (114cm) and PB5598 57" (145cm).



PB5556 Black Molded Swing-Away Tray-21"Lx24"W
Swing-away tray is accessible in all positions and provides anterior support as user moves from supine to upright and prone positions. Adjustable in depth, height and tray angle. Tray size is 21"Lx24"W (53x61cm).



P80246 Angle Locator
Magnetic angle locator can be utilized for standing progress and leg abduction.

The Prone base includes:

- Four Swivel Locking Casters
- Foot Operated Gas Spring or Pow'r Up Lift
- Mast Receiver



PB5606 Zing Prone Base Gas Spring Lift

Comes with four swivel locking casters, foot operated gas spring and a mast receiver.



PB5608 Zing Prone Base Pow'r Up Lift

Comes with four swivel locking casters, Pow'r Up Lift, mast receiver.



PB5512 Mast

Mast is the base for support and positioning components.



PB5514 Mast with Leg Abduction

Mast is the base for support and positioning components and allows for 0-30° of independent leg abduction. Multi-adjustable knee pads and multi-adjustable foot plates required for leg abduction.



PB5640 Dual Control

Allows both foot and hand control of the gas spring lift. Push handle PB5632 required.



PA5614 Gas Spring Lift Lockout

Locks gas spring in any position from lying down to fully upright and supine positions.



PB5510 Directional Locking Caster

Great for transporting stander. Directionally locks one caster while leaving the other three free to swivel.



PB5612 Platform Foot Plate

Adjustable in height. Foot holders and foot straps can be added for more precise positioning of the feet.



PB5616, PB5618, PB5620 Multi-Adjustable Foot Plates

Foot plates are adjustable forward/aft +/- .75" (2cm) +extra 1.5" (3.8cm), plantar/dorsi +/- 20°, toe-in/toe-out, swivel 30° left/right and in height. Foot holder sizes: PB5616 7.75"Lx3.25"W (20x8cm), PB5618 9.75"Lx4"W (25x10cm), PB5620 11.75"Lx5"W (30x13cm).



PA5542, PA5544, PB5526 Foot Holders for Platform Foot Plate

Use with the platform foot plate, gives added positioning of users feet. Foot holder sizes: PA5542 7.75"Lx3.25"W (20x8cm), PA5544 9.75"Lx4"W (25x10cm), PB5526 11.75"Lx5"W (30x13cm).



**PT50082 Secure Foot Straps-10"L
PY5638 Secure Foot Straps-15"L
PNG50506 Secure Foot Straps-21"L**

Velcro® and D-ring adjustment holds feet securely in place at ankles and toes with multiple attachment slots for proper foot positioning. Straps measured in length over top of foot, with approximately 1.5" (4cm) of Velcro® overlap.



**PT50080 Foot Straps-10"L
PY5636 Foot Straps-15"L
PNG50505 Foot Straps-21"L**

Velcro® and D-ring adjustment holds feet in alignment with multiple attachment slots for proper foot positioning. Straps measured in length over top of foot, with approximately 1.5" (4cm) of Velcro® overlap.



PB5528 Calf/Knee Pad with Strap

17.5"x5.5" (44x14cm) pad attached to a 2" (5cm) Velcro® belt with a D-Ring closure, provides calf/knee stability for user. Fits circumference up to 28"-38" (71-97cm). Gives support from the back of the calf/knee. Adjustable in height and fore/aft.



PB5622, PB5624, PB5626 Multi-Adjustable Knee Pads

Multi-adjustable knee pads are adjustable in swivel, height +/- .75" (2cm), PA5622 inside width 3.25" (8cm), PA5624 inside width 4.25" (11cm) and PB5626 inside width 5" (13cm). With a depth range of 7" (18cm).



PB5636 Knee Strap

4"x6" (10x15cm) pad attached to a 2" (5cm) Velcro® belt with a D-Ring closure. Fits circumference up to 19" (48cm). Adjustable in height. For PB5622, PB5624 and PB5626.



PA5731 Knee Depth Stop

For multi-adjustable knee pads only.



**PB3000 Planar Pad-10"Hx11"W
PB3002 Planar Pad-10"Hx13"W**

Cushioned pad covered with Neoprene®. Pad sizes: PB3000 10"Hx11"W (25x28cm) PB3002 10"Hx13"W (25x33cm).



**PB3004 Form to Fit Pad-10"Hx11"W
PB3006 Form to Fit Pad-10"Hx13"W**

Form to fit pad can be custom fit to the user. Pad sizes: PB3004 10"Hx11"W (25x28cm) PB3006 10"Hx13"W (25x33cm).



PB5538, PB5540 Hip Supports

Keeps the hips in symmetrical alignment. Adjustable from PB5538 7"-13" (18-33cm) and PB5540 12"-18" (30-46cm) with fore/aft 4" (10cm). Pad size is 4.5"x4" (11x10cm). For planar pads only.



PT30066 Pelvic Positioning Strap

2" (5cm) wide belt has a Velcro® belt with a D-Ring closure, provides hip stability for user. Fits circumference up to 35" (89cm).



PB5542 Pelvic Padded Positioning Strap

6"x10" (15x25cm) pad attached to a 2" (5cm) Velcro® belt with a D-Ring closure. Fits circumference up to 35" (89cm).



PB3025, PB3026 Hygienic Cover
Washable slip on cover available in five different patterns. For planar pads PB3000 and PB3002.



PB3049 Hygienic Cover for Lateral Supports
Washable slip on cover available in five different patterns. For lateral supports PA5627 and PB5627.



PNG50042 Hand Grips
Provides additional arm and hand support and alignment. Easily movable for precise arm positioning. Attaches with suction cups.



PB3027, PB3028 Hygienic Cover
Washable slip on cover available in five different patterns. For form to fit pads PB3004 and PB3006.



PB5638 Face Aperture-9"H
Pad size is 9"Hx3"W (23x8cm). With a 7" (18cm) range from the upper body support, individual face aperture pads are adjustable. Supports the head.



PB5632 Push Handle for Tray
Makes pushing the stander easier for the caregiver and also aids in lifting and lowering the child. Required for dual control.



PA3006, PA3007, PA3041, PA3042 Planar Pad
Cushioned pad covered with Neoprene®. Pad sizes:
PA3006-5"Hx7"W (13x18cm)
PA3007-5"Hx9"W (13x21cm)
PA3041-7"Hx7"W (18x18cm)
PA3042-7"Hx9"W (18x21cm)



PA5710 Hygienic Cover
Washable slip on cover available in five different patterns. For face aperture PB5638.



P80809 Tool Pouch
Holds the assembly tools provided with the stander. Attaches to unit with Velcro® straps.



PA3079, PB3046, PA3081, PB3047 Form to Fit Pad
Form to fit pad with extra sternum positioning. Built in lateral support that can be custom fit to the user. Pad sizes are:
PA3079-5"Hx12"W (13x30cm)
PB3046-6"Hx13"W (15x33cm)
PA3081-7"Hx12"W (18x30cm)
PB3047-10"Hx13"W (25x33cm)



PB5628 Black Molded Tray-21"Lx24"W
Tray provides anterior support. Adjustable in depth and height. Tray size is 21"Lx24"W (53x61cm).



P80246 Angle Locator
Magnetic angle locator can be utilized for standing progress and leg abduction.



PB5657 Lateral Supports Flat Pads
Keeps the upper torso in symmetrical alignment. Adjustable range of 7"-12" (18-30cm) with 7"W planar pads, 9"-14" (23-36cm) with 9"W planar pads. Pad size is 4"Hx6"W (10x15cm). For planar pads only.



PB5630 Clear Tray-21"Lx24"W
Tray provides anterior support. Adjustable in depth, height and tray angle. Tray size is 21"Lx24"W (53x61cm).



PB5627 Lateral Supports Curved Pads
Keeps the upper torso in symmetrical alignment. Adjustable range of 7"-12" (18-30cm) with 7"W planar pads, 9"-14" (23-36cm) with 9"W planar pads. Pad size is 4"Hx6.25"W (10x16cm). For planar pads only.



PT50156 Elbow Pad-9.25" Cutout
Additional padded support surface on the black molded or clear tray. 9.25" (24cm) cutout width. Overall width 21.5" (55cm), pad extends back 3.75" (10cm) posterior from current table edge for additional upper body/extremity support.



PB5542 Upper Body Padded Positioning Strap
6"x10" (15x25cm) pad attached to a 2" (5cm) Velcro® belt with a D-Ring closure. Fits circumference up to 35" (89cm).



PT50160 Elbow Pad-11" Cutout
Additional padded support surface on the black molded or clear tray. 11" (28cm) cutout width. Overall width 21.5" (55cm), pad extends back 3.75" (10cm) posterior from current table edge for additional upper body/extremity support.



PA3028, PA3029, PA3045, PA3046 Hygienic Cover
Washable slip on cover available in five different patterns. For planar pads PA3006, PA3007, PA3041 and PA3042.



PY5582 Elbow Pad-13" Cutout
Additional padded support surface on the black molded or clear tray. 13" (33cm) cutout width. Overall width 21.5" (55cm), pad extends back 3.75" (10cm) posterior from current table edge for additional upper body/extremity support.



PA3086, PB3050, PA3088, PB3051 Hygienic Cover
Washable slip on cover available in five different patterns. For form to fit pads PA3079, PB3046, PA3081 and PB3047.

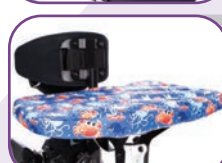

PT30093 Hygienic Padded Cover
Washable slip on cover is padded and available in five different patterns.