



# EasyStand Zing size 2

Owner's Manual

Please ensure the Owner's Manual stays with the unit at all times.

## SYMBOL LEGEND



**CAUTION/ATTENTION**



**ENVIRONMENTAL  
CONDITIONS**



**TYPE BF APPLIED PART**



**DATE OF MANUFACTURE**



**PINCHPOINT**



**SEE INSTRUCTIONS FOR USE**

**SN**

**SERIAL NUMBER**



**MANUFACTURER**



Please be environmentally responsible and recycle this product through your recycling facility at its end of life.

**R<sub>x</sub>only**

Afin de préserver l'environnement, veuillez confier ce produit à votre centre de recyclage à la fin de sa durée de vie.

Nachdem dieses Produkt ausgedient hat, entsorgen Sie es bitte auf umweltfreundliche Weise, indem Sie es zu der entsprechenden Recyclingstelle bringen.

Wees a.u.b. milieubewust en recycleer dit product via uw recycleerder na het verstrijken van de levensduur.

Sea responsable con respecto al medio ambiente y recicle este producto al finalizar su vida útil en el lugar de reciclaje correspondiente.

Siate responsabili verso l'ambiente e riciclate questo prodotto, al termine della sua vita d'uso, presso la vostra sede di riciclaggio.

Kierrätä tämä tuote sen käyttöiän lopussa ympäristövastuullisella tavalla paikallisella kierrätyslaitoksella.

Var miljomedveten och återvinn denna produkt efter dess användning.

Vi ber deg ta hensyn til miljøet og resyklere dette produktet ved hjelp av de rette resyklingsfasilitetene når produktet ikke lenger kan brukes.

Vis venligst hensyn til miljøet ved at levere produktet til det nærmeste genbrugsanlæg, når det ikke længere fungerer.

Por favor, assumo responsabilidade ambiental, reciclando este produto em suas instalações de reciclagem no final de sua vida útil.

# Table of Contents

<b>Introduction</b> .....	<b>1</b>
<b>Safety Precautions</b> .....	<b>2</b>
<b>Assembly</b> .....	<b>3</b>
<b>Pow'r Up Lift</b> .....	<b>22</b>
<b>Option Adjustments and Usage</b> .....	<b>26</b>
<b>Parts Detail</b> .....	<b>34</b>
<b>Maintenance</b> .....	<b>39</b>
<b>Limited Warranty</b> .....	<b>40</b>

Date Purchased \_\_\_\_\_ Serial # \_\_\_\_\_

# Introduction

Congratulations on your purchase of the EasyStand Zing standing frame. We at Altimate Medical have designed the EasyStand Zing with your needs in mind.

## EasyStand Description

The EasyStand line of products is intended for individuals who are able to transfer with assistance from a caregiver and/or lifting device. It is a useful tool for rehabilitation, home, school, and work use. EasyStand standing frames support the user from various positions to the standing position. Various support and positioning options may be added to facilitate individual needs.

## Indications for Use

The Zing Size 2 is indicated for most individuals weighing up to 154 lbs. and within the height range of 40 to 60 inches.

## Intended Use

The EasyStand Zing products have a manual or electrically operated flat surface (electric option offered on Zing Size 2 only) that can be adjusted to various positions (i.e. prone or supine) to increase tolerance to an upright standing position.

**This manual is an integral part of your standing system and should be read completely and thoroughly by anyone that will be operating the unit.** This will ensure the EasyStand Zing is assembled properly and used in the most beneficial manner.

It is necessary to inspect your EasyStand Zing at least weekly to ensure it is in safe operating condition. EasyStand adjustments that are listed in the product owner's manual can be made by the operator by following the instructions for use. After an adjustment is made, inspect the EasyStand to ensure all hardware and adjustable components are properly secured per the instructions for use. Replacement of worn parts, major adjustments, or any other important corrections should be handled by an authorized supplier or service center. Only Altimate Medical, Inc., approved replacement parts should be used to ensure safety and performance.

**The EasyStand Zing shall be prescribed by a qualified physician or occupational/physical therapist. Do not use the EasyStand Zing without consulting your physician and receiving protocol for a standing program. Failure to consult a qualified physician prior to using the EasyStand Zing could lead to medical problems. The EasyStand Zing must be used with a qualified adult attendant present. Should any problems arise that you cannot solve by reading this manual, please contact your local supplier or call Altimate Medical, Inc., at 800-342-8968 or 507-697-6393. **

## Join the Standing Community!

Our goal is simple - to empower people with disabilities to stand up for their health. Connect, share, and learn from other people with disabilities, special needs parents, clinical professionals, and the experts in standing on one of our social networking communities.

Read, share, and comment on the EasyStand Blog at [blog.easystand.com](http://blog.easystand.com)  
Find EasyStand on these social networking sites:



# Safety Precautions

- Please read and understand all safety precautions and user instructions prior to use. Call Altimate Medical at 800-342-8968 or 507-697-6393 with any questions or for additional information.
- If a user does not meet the specifications below and has not been properly fitted by a qualified therapist or physician, Altimate Medical, Inc., does not recommend using the EasyStand Zing.

**Zing Size 2-** is designed to accommodate most individuals up to 40"-60" (102-152cm) and up to 154 lbs. (70 kg).

**Overall dimensions of Zing Size 2 (approximate):**

- The maximum mass plus its safe working load is approximately 299 lbs. (136 kg)
    - The maximum width is 28.75" (730 mm)
  - The maximum height while unit is in standing position is 71" (1803 mm)
  - The maximum length while unit is in supine position is 72" (1829 mm)
- For more detailed specifications visit our website [www.easystand.com](http://www.easystand.com)*

- The EasyStand Zing should not be used without first consulting a qualified physician. Failure to consult a qualified physician prior to using the EasyStand Zing could lead to medical problems. We recommend a good standing program be established and supervised by a qualified, registered physical/occupational therapist.
- The EasyStand Zing should always be used with a qualified adult attendant present. Consult with your therapist or physician for proper foot placement and angle. Never leave a child unattended in the Zing.
- Do not make foot plate adjustments to the Zing while a child is standing.
- It is necessary to inspect the EasyStand Zing at least weekly to ensure it is in safe operating condition. Pay particular attention for loose hardware. If the EasyStand is equipped with the optional Pow'r up option, please inspect the electrical cables for any wear and ensure they are attached properly. Replacement of worn parts, major adjustments, or other important corrections should be handled by an authorized dealer or service center. Only Altimate Medical, Inc., approved replacement parts should be used to ensure safety and performance.
- If the EasyStand is being used in the home environment, please inspect the unit prior to each use to ensure there is no damage or unexpected wear to the EasyStand that may have been caused unintentionally by pets, pests or children.
- Ensure the necessary support and alignment options are in position prior to bringing the child into the standing position.
- If the unit was exposed to temperatures of less than 50°F (23.5°C), the unit must warm to room temperature before use.
- **Operating Conditions:** Temperature: 41°F (5°C) -95°F (35°C), Relative humidity: 20% - 90% at 86°F (30°C), Atmospheric Pressure: 700 to 1060hPa.
- **Storage/Transport Conditions:** Temperature: 14°F (-10°C) -122°F (50°C), Relative humidity: 20% - 90% at 86°F (30°C), Atmospheric Pressure: 700 to 1060hPa.
- The EasyStand can be used at a maximum altitude of 10,000 feet (3,050 meters).
- The expected service life of an EasyStand is considered 5 years under normal use conditions. Note: This may vary based on frequency of use.
- If you must transport the EasyStand in a vehicle, secure the unit so it does not move around. After transport inspect the EasyStand to ensure hardware is properly tightened and all options are secured.
- Standing equipment is designed for indoor use on level surfaces only. Keep casters locked while in use.
- Transporting the unit with a user in the standing position is not recommended.
- Extreme movements laterally or front to back may cause the unit to tip.
- It is recommended the equipment be stored at normal room temperature and humidity levels.
- Altimate Medical products are specifically designed to be used with Altimate Medical accessories and options. Unless otherwise noted, accessories and options from other manufacturers have not been tested by Altimate Medical and are not recommended for use with Altimate Medical products.
- Product Modifications made without express written consent (including, but not limited to, modification through the use of unauthorized parts or attachments) are not recommended and will void the product warranty.
- The EasyStand Zing with the Pow'r Up Option meets the requirements of IEC 60601-1 and 60601-1-2.\*

**⚠ Caution:** The EasyStand is constructed of materials that do not support combustion under normal conditions. For the safety of the patient and attending personnel, do not allow clutter or debris to be stored or accumulate on or around the equipment.

**⚠ Caution:** This equipment is designed to accommodate a range of users; therefore the unit has various adjustment slots and holes. Avoid placing fingers or other body parts in any of these areas.

**⚠ Caution:** While in use this equipment has various moving parts, familiarize yourself with the unit and avoid placing hands or fingers near any of these areas.

**⚠ Caution:** Advise bystanders to keep clear of the unit while in use.

\* Zing Pow'r Up Lift Option Only

# Assembly

1. Remove everything from the box.

Remove all plastic wrap and parts from the boxes.



2. Remove the bag of hardware from the wheelbase. It contains the 4 bolts for the mast assembly.



3. Position the mast as shown, place the wheelbase as shown onto the mast.



4A. Start all 4 bolts. Do not tighten at this time.

4B. Once all 4 bolts have been started, tighten them securely.



5. Remove the wrapping and bolts from the foot pedal and place the foot pedal onto the bottom of the gas spring as shown.



6. Line up holes and insert the 2 bolts, start both bolts first, then tighten securely.





7. Place unit onto its wheels as shown, and lock casters.



8. If the Gas Spring Lockout was ordered, unlock the gas spring by pulling the plunger. (see page 33)  
If the Gas Spring Lockout was not ordered, remove the bolt from the lower part of the cylinder on the mast as shown, discard bolt.

If the Pow'r Up Lift was ordered, plug the battery and controller in.

See Fig. B on page 22 for information on the Pow'r Up Lift.



9. Remove the nut, bolt and two washers from the brace. These will be used in steps 10-15.





10. Flip up the brace as shown.

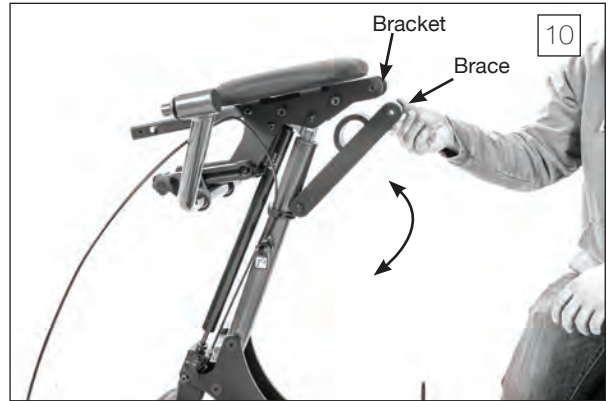

11. Depress the foot pedal to allow the mast to expand about 2 inches.

For the Pow'r Up Lift, use the controller to allow the unit to expand about 2 inches.



12. Insert brace into the bracket and line up holes. Insert washer in between the bracket and the brace. You may need a rubber mallet to assist.



13. Insert bolt into the hole about halfway through the brace.



14A. Insert washer on the other side of the brace and line up holes. You may need to use a flat head screwdriver to assist with the opening.



14B. Insert the bolt all the way through the holes. You may need a rubber mallet to assist.



15. Place nut onto bolt and tighten securely with hex wrench and open ended wrench.

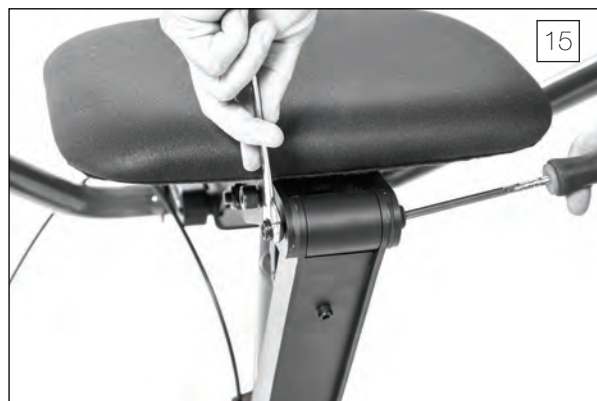

16. For the leg assembly, remove the two bolts behind the support pad. Set aside.



17. Place leg assembly onto unit as shown and line up holes. Making sure the ratchet handle and knee clamp are facing towards the rear of the unit. Insert both bolts and tighten securely. Repeat steps 16 and 17 for the other leg.

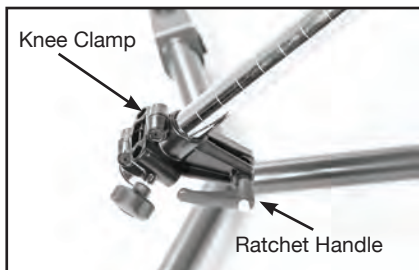

18. Legs should be installed as shown.



*If a Tilt Table (TT) model was ordered, skip to step 23.  
If a Prone model was ordered, skip to step 29.*

MPS and Supine

19. Loosen the knob on the upper body support.



MPS and Supine

20. Place upper body support onto post as shown. Depress spring button and place into position.



MPS and Supine

21. Tighten knob securely.



22. Loosen knob on head support bracket, insert head support and tighten knob securely.



23. If a Tilt Table (TT) model was ordered follow steps 23-27, remove the 6 bolts from the back of the upper body support pad.

Tilt Table



24. Place pad onto unit as shown. Line up the 2 middle holes on the pad with the bracket on the unit, insert 2 bolts and tighten snug.

Tilt Table





Tilt Table

25. Using a hex wrench, insert 2 lower bolts into the holes on the pad. Tighten snug.

Note: Use the 2 holes on the bracket to access the lower holes in the pad.



Tilt Table

26. Place head support/push handle bracket into support tube as shown.



Tilt Table

27. Line up 2 holes on the bracket with the 2 upper holes on the pad. Insert bolts and tighten all 6 bolts on the pad securely.



28A. If the optional chest strap was ordered, place it around the pad as shown.

28B. Position strap in the grooves on the support bracket as shown.



Tilt Table



29. If the Prone model was ordered follow steps 29-35, remove the cap on the support tube and discard. A flat screw driver may be needed.



Prone

30. Using a hex wrench, loosen the set screw some, but do not remove.



Prone



31. Loosen knob and insert upper body support into the support tube and tighten knob securely. Tighten set screw.

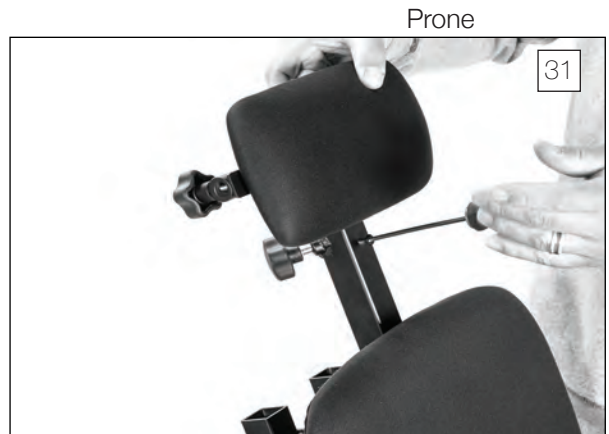

32. If the face aperture was ordered. Depress the spring button and place it onto the support tube.



33. If the push handle for the tray was ordered, place tray as shown, remove the 2 bolts from the support brackets on the tray. Make sure the covered brackets stay in place.



34. Place the push handle for the tray onto the support brackets as shown.

Prone



35A. Line up holes on support brackets and push handle. Insert bolts and tighten securely.

35B. Repeat steps 33-35 for other side of tray.

Prone



*If a Prone model was ordered, skip to step 43.*

36. If the tray with the arms was ordered, place the tray upside down as shown. Flip the chrome arms as shown, remove 4 bolts from bottom of the tray. Place arm brackets onto tray and line up holes in arm bracket with holes on the tray. Insert 4 bolts and tighten securely. If the swing-away tray was ordered, skip to step 39.

MPS, Supine, TT

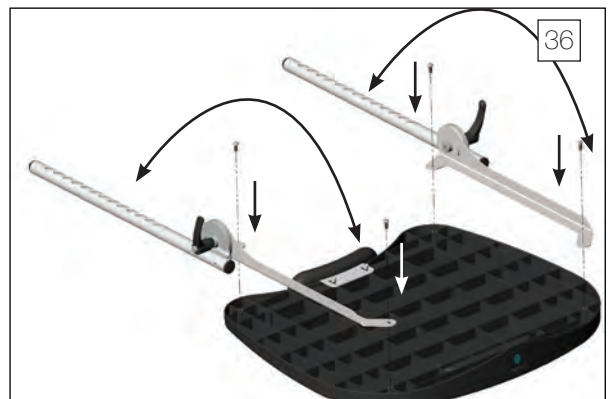

37. Loosen knobs on the tray brackets and flip open the gray latch all the way as shown below.



38. Lock the casters, insert the two tray arms into the tray bracket on the bottom of the tray as shown. Flip gray latch closed, and tighten knob securely.

⚠ **Caution:** After placing the tray into position, ensure the ratchet handles on both sides of the tray are tightened securely.



39. If the swing-away tray was ordered follow steps 39-42, using a wrench, remove the nut from the bolt on the tray arm and discard the nut. Make sure all other hardware stays on the bolt.

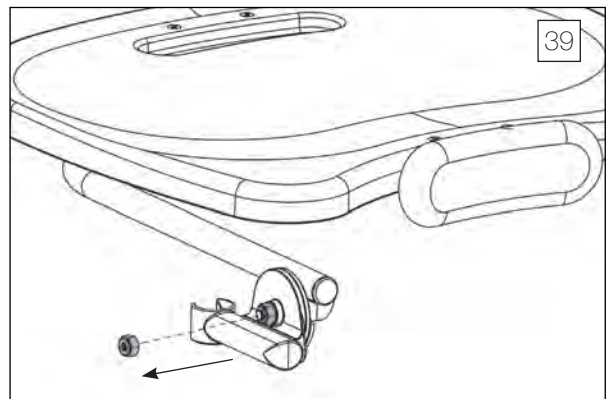

40. Flip the tray arm as shown.

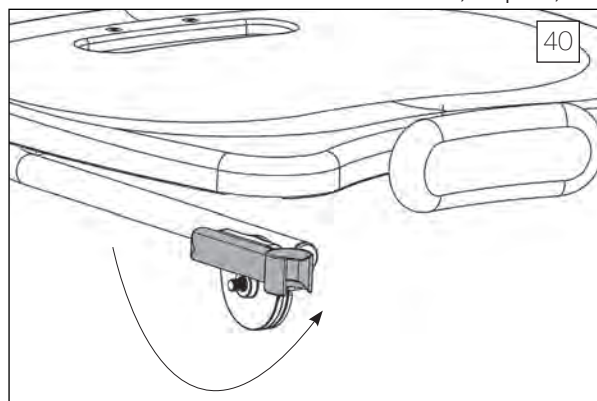

41. Place the ratchet handle that was sent with the manual onto the bolt and tighten securely.

Repeat steps for the other side.

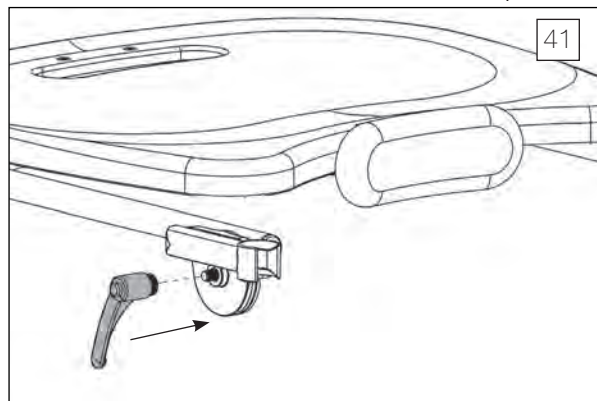

42. There are 2 knobs in the parts bag. Screw each knob slightly into the tray bracket on the unit. Place tray onto unit. Tighten both knobs securely.



43. If the Prone model was ordered. Loosen ratchet handles on the side of the tray. Flip tray support brackets up as shown. Tighten ratchet handles securely.



44. Insert tray support brackets into the following tubes as shown. Depress spring button and place tray into desired position, tighten knobs securely.



45. If the lateral supports were ordered, loosen knob on the lateral support clamp behind the upper body support pad. Insert lateral supports and tighten knob securely. Repeat steps for other lateral support.

Prone Lateral Supports



Lateral Supports



Elbow Stop/Arm Rest

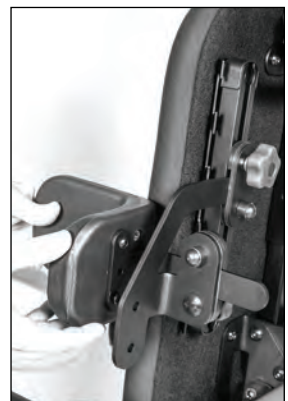



46. If hip supports were ordered, loosen knob on the hip support bracket on the leg. Insert hip support as shown, tighten knob securely. Repeat steps for other hip support bracket.



47. If the multi-adjustable knee pads were ordered, loosen ratchet handles on the knee clamps. Raise up into desired position and tighten ratchet handle securely. Repeat steps for other knee clamp.

Calf Pad with Knee Strap



Loosen knobs and place onto legs as shown.  
Tighten knobs securely when in position.

48. Loosen knob on knee clamp, insert knee pad bracket and tighten knob securely. Repeat steps for other knee.



MPS, Supine, TT



Prone



49. If the multi-adjustable foot plates were ordered, loosen ratchet handle on foot plate, place foot plate bracket onto the leg as shown, place in desired position and tighten ratchet handle securely. Repeat steps for other foot plate.

Platform Foot Plate

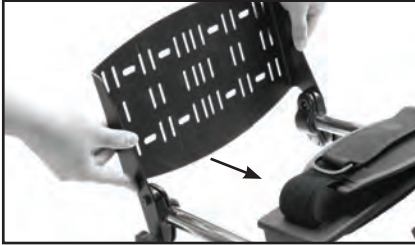

Loosen knobs and place onto legs as shown.  
Tighten knobs securely when in position.

***If a Prone model was ordered, skip to step 55.***

50. If the dual control option was ordered, insert handle and cable behind the support bracket and leg bracket.

MPS, Supine, TT



Prone



MPS, Supine, TT



51. Pull handle and cable through between the pad and the leg bracket as shown.

MPS, Supine, TT





52. Guide cable up behind pad. Make sure to guide cable on the back side of the push handle.



53. Remove bolt from the controller handle, place controller handle onto the push handle as shown. Insert bolt through the hole and tighten to the controller handle.



54. Use zip tie to secure cable to lower part of the push handle.



55. If the dual control was ordered, remove bolt from the controller handle, place controller handle onto the push handle as shown. Insert bolt through hole and tighten to the controller handle.

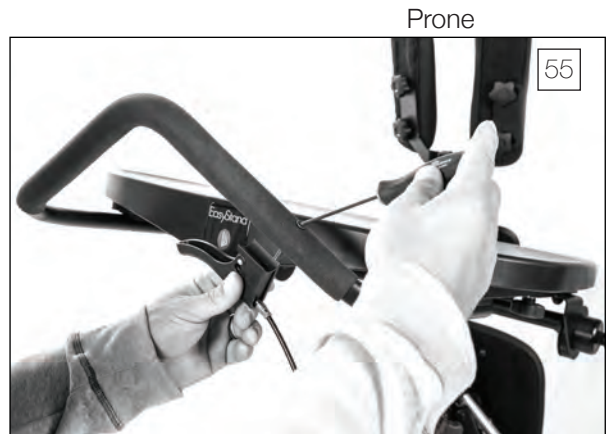

56. Guide the cable under the tray and use provided zip tie to secure the cable.

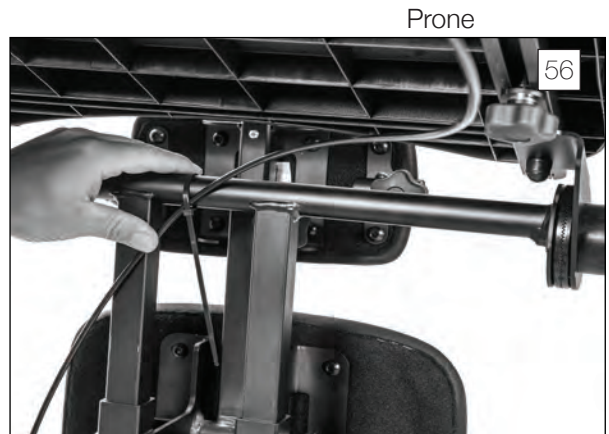

57. Guide the cable following the push handle and use provided zip tie to secure the cable.



# Pow'r Up Lift Option Usage

## Charging the Battery

The EasyStand Zing Pow'r Up Lift uses two 12-volt sealed lead batteries rated at 2.9 amps each. An EasyStand Zing can be lifted approximately 100 times on one full battery charge. An audible alarm will sound when the battery is low. Please charge the battery after the alarm sounds. A battery needing to be fully recharged will take approximately 8 hours. The EasyStand Zing Pow'r Up Lift can be used while being charged. The function of the charger is to detect a full battery and then provide a constant potential power supply to hold the battery at a full condition without overcharging. When the battery EMF rises to a factory preset point, the charger circuit will not allow the peak output voltage to exceed that value. This factory setting protects a battery from excessive depletion of electrolyte, which can occur from overcharging. The charger can be found in the tool pouch on the back of the unit.

**CAUTION:** Use only the Linak charger, model number 10CH01S-00, provided by Altimate Medical with the Pow'r Up option.

1. Plug the receptacle into a wall outlet. The length of the charger cable is 80" (203cm). The light on the charger will be green indicating an open circuit.
2. **FIG. A-** Plug the charger cord into the side of the hand control. The light on the charger will turn yellow indicating the batteries are being charged. The length of the hand pendant cable is 30" (76cm), retracted.
3. **FIG. B-** The unit will arrive unplugged from the battery, plug in the white cord that supplies power to the actuator and the black cord that supplies power to the remote. The black cord has a notch on it to orient the connector properly. Fully charge battery before use.  
*Note:* The white cord has a rubber washer on it, which makes it very sticky and sometimes will not get pushed in completely, make sure to push the cord all the way into the battery.
4. When the batteries are charged, the light on the charger will turn green.
5. Fully charge the batteries every three months or less during periods of intermittent or non-use.

**CAUTION:** The Zing Pow'r Up Option is not designed for continuous use. Duty Cycle 5% Max, 1 min. / 19 min.

**Raising the Lift** - Press the UP (arrow up) button on the hand control to lift the Zing.

**Lowering the Lift** - Press the DOWN (arrow down) button on the hand control to lower the Zing.

**CAUTION:** Ensure the cables are attached properly per the instructions for use. Do not allow the cables to drag on the floor or to catch on objects.

**FIG. A**

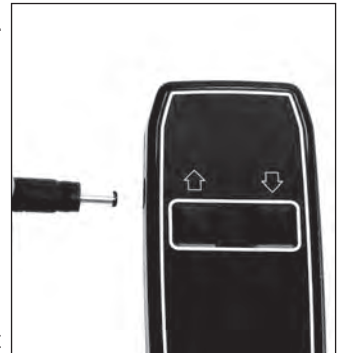

The hand pendant is a Type BF applied part.

**FIG. B**

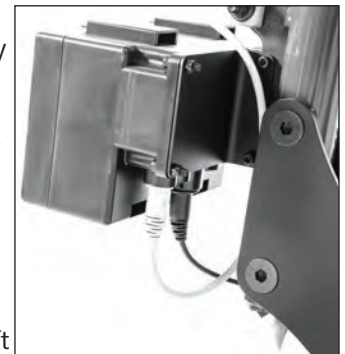

## Battery Replacement

The batteries are enclosed in the control box of the Pow'r Up Lift (the black box where the cords are plugged in). Once the batteries have reached their end of life and need to be replaced, do not open the control box; please contact Altimate Medical Customer Service or your medical equipment dealer for information about purchasing a replacement control box. It is recommended that the batteries be replaced every four years. Please contact a local recycling authority for information about disposing of the old batteries.

## IP Rating

The IP rating is a classification system indicating the protection degree from dust, water and impact for electrical equipment and enclosures. Pow'r Up Lift components are rated at IP21. The definition for IP21 is as follows:

**First character definition:** 2 - Protected against solid foreign objects of 12.5mm diameter and greater.

**Second character definition:** 1 - Protected against vertically falling water drops.

## Electromagnetic compatibility

Pow'r Up Option components have been designed and tested to meet the applicable EMC requirements. It is unlikely that you will encounter problems with your EasyStand due to inadequate electromagnetic compatibility. However, if you notice any unusual (such as intermittent) behavior of your Pow'r Up option and the EasyStand is being used next to possible interfering equipment such as mobile phones, microwaves, or radio broadcast masts, this could be an indication of electromagnetic interference. If such behavior occurs move the EasyStand away from the interfering equipment. Please report any instance of possible electromagnetic interference to AMI's Customer Service Department.



**WARNING:** Use of accessories, transducers and cables other than those specified or provided by the manufacturer of this equipment could result in increased electromagnetic emissions or decreased electromagnetic immunity of this equipment and result in improper operation.

### Recommended separation distances between portable and mobile RF communications equipment and the EasyStand Zing.

The EasyStand Zing is intended for use in an electromagnetic environment in which radiated RF disturbances are controlled. The customer or the user of the EasyStand Zing can help prevent electromagnetic interference by maintaining a minimum distance between portable and mobile RF communications equipment (transmitters) and the EasyStand Zing as recommended below, according to the maximum output power of the communications equipment.			
Rated maximum output power of transmitter W	Separation distance according to frequency of transmitter m		
	150 kHz to 80 MHz $d = 1.2 \sqrt{P}$	80 MHz to 800 MHz $d = 1.2 \sqrt{P}$	800 MHz to 2.5 GHz $d = 2.3 \sqrt{P}$
0.01	.12	.12	.23
0.1	.38	.38	.73
1	1.2	1.2	2.3
10	3.8	3.8	7.3
100	12	12	23

For transmitters rated at a maximum output power not listed above, the recommended separation distance  $d$  in meters (m) can be estimated using the equation applicable to the frequency of the transmitter, where  $P$  is the maximum output power rating of the transmitter in watts (W) according to the transmitter manufacturer.

*NOTE 1: At 80 MHz and 800 MHz, the higher frequency range applies.*

*NOTE 2: These guidelines may not apply in all situations. Electromagnetic propagation is affected by absorption and reflection from structures, objects, and people.*

## Guidance and Manufacturer's Declaration - Electromagnetic Immunity

The EasyStand Zing is intended for use in the electromagnetic environment specified below. The customer or the user of the EasyStand Zing should assure that it is used in such an environment.

Immunity Test	IEC 60601 Test Level	Compliance Level	Electromagnetic Environment - Guidance
<p>Conducted RF IEC 61000-4-6</p> <p>Radiated RF IEC 61000-4-3</p>	<p>6 Vrms 150 kHz to 80 MHz</p> <p>3 V/m 80 MHz to 2.7 GHz</p>	<p>6 Vrms</p> <p>3 V/m</p>	<p>Portable and mobile RF communications equipment should be used no closer to any part of the EasyStand Zing, including cables, than the recommended separation distance calculated from the equation applicable to the frequency of the transmitter.</p> <p>Recommended separation distance</p> $d = 1.2 \sqrt{P}$ <p><math>d = 1.2 \sqrt{P}</math> 80 MHz to 800 MHz</p> <p><math>d = 2.3 \sqrt{P}</math> 800 MHz to 2.7 GHz</p> <p>Where <math>P</math> is the maximum output power rating of the transmitter in watts (W) according to the transmitter manufacturer and <math>d</math> is the recommended separation distance in meters (m).</p> <p>Field strengths from fixed RF transmitters, as determined by an electromagnetic site survey<sup>a</sup>, should be less than the compliance level in each frequency range.<sup>b</sup></p> <p>Interference may occur in the vicinity of equipment marked with the following symbol:</p> <div style="text-align: center;">  </div>

*NOTE 1: At 80 MHz and 800 MHz, the higher frequency range applies.*

*NOTE 2: These guidelines may not apply in all situations. Electromagnetic propagation is affected by absorption and reflection from structures, objects, and people.*

<sup>a</sup> Field strengths from fixed transmitters, such as base stations for radio (cellular/cordless) telephones and land mobile radios, amateur radio, AM and FM radio broadcast and TV broadcast cannot be predicted theoretically with accuracy. To assess the electromagnetic environment due to fixed RF transmitters, an electromagnetic site survey should be considered. If the measured field strength in the location in which the EasyStand Zing is used exceeds the applicable RF compliance level above, the EasyStand Zing should be observed to verify normal operation. If abnormal performance is observed, additional measures may be necessary, such as re-orienting or relocating the EasyStand Zing.

<sup>b</sup> Over the frequency range 150 kHz to 80 MHz, field strengths should be less than 3 V/m.

Note: The EMISSIONS characteristics of this equipment make it suitable for use in industrial areas and hospitals (CISPR 11 class A). If it is used in a residential environment (for with CISPR 11 class B is normally required) this equipment might not offer adequate protection to radio-frequency communication services. The user might need to take mitigation measures, such as relocating or re-orienting the equipment.

## Guidance and Manufacturer's Declaration - Electromagnetic Emissions

The EasyStand Zing is intended for use in the electromagnetic environment specified below. The customer or the user of the EasyStand Zing should assure that it is used in such an environment.		
Emissions Test	Compliance	Electromagnetic Environment - Guidance
RF emissions CISPR 11	Group 1	The EasyStand Zing uses RF energy only for its internal function. Therefore, its RF emissions are very low and are not likely to cause any interference in nearby electronic equipment.
RF emissions CISPR 11	Class B	The EasyStand Zing is suitable for use in all establishments, including domestic establishments and those directly connected to the public low-voltage power supply network that supplies buildings used for domestic purposes.
Harmonic emissions IEC 61000-3-2	Class A	
Voltage fluctuations/ Flicker emissions IEC 61000-3-3	Complies	

## Guidance and Manufacturer's Declaration - Electromagnetic Immunity

The EasyStand Zing is intended for use in the electromagnetic environment specified below. The customer or the user of the EasyStand Zing should assure that it is used in such an environment.			
Immunity Test	IEC 60601 Test Level	Compliance Level	Electromagnetic Environment - Guidance
Electrostatic Discharge (ESD) IEC 61000-4-2	± 8 kV contact ± 15 kV air	± 8 kV contact ± 15 kV air	Floors should be wood, concrete, or ceramic tile. If floors are covered with synthetic material, the relative humidity should be at least 30 %.
Electrical Fast Transient/Burst IEC 61000-4-4	± 2 kV for power supply lines ± 1 kV for input/output lines	± 2 kV for power supply lines ± 1 kV for input/output lines	Mains power quality should be that of a typical commercial or hospital environment.
Surge IEC 61000-4-5	± 1 kV line(s) to line(s) ± 2 kV line(s) to earth	± 1 kV line(s) to line(s) ± 2 kV line(s) to earth	Mains power quality should be that of a typical commercial or hospital environment.
Voltage dips, short interruptions and voltage variations on power supply input lines IEC 61000-4-11	<5 % $U_T$ (>95 % dip in $U_T$ ) for 0,5 cycle 40 % $U_T$ (60 % dip in $U_T$ ) for 5 cycles 70 % $U_T$ (30 % dip in $U_T$ ) for 25 cycles <5 % $U_T$ (>95 % dip in $U_T$ ) for 5 s	<5 % $U_T$ (>95 % dip in $U_T$ ) for 0,5 cycle 40 % $U_T$ (60 % dip in $U_T$ ) for 5 cycles 70 % $U_T$ (30 % dip in $U_T$ ) for 25 cycles <5 % $U_T$ (>95 % dip in $U_T$ ) for 5 s	Mains power quality should be that of a typical commercial or hospital environment. If the user of the EasyStand Zing requires continued operation during power mains interruptions, it is recommended that the EasyStand Zing be powered from an uninterruptible power supply or a battery.
Power frequency (50/60 Hz) magnetic field IEC 61000-4-8	30 A/m	30 A/m	Power frequency magnetic fields should be at levels characteristic of a typical location in a typical commercial or hospital environment.
<i>NOTE: <math>U_T</math> is the a.c. mains voltage prior to application of the test level.</i>			



# Option Adjustments & Usage

## Trays

### Black Molded/Swing-Away Tray Height

58. To adjust tray height, loosen knobs on the back of unit and set to desired position. Tighten securely.

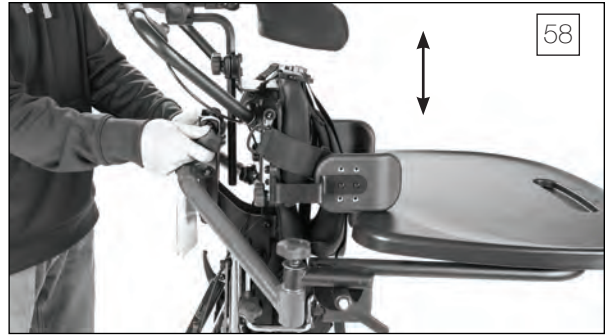

### Black Molded Tray Depth

59. To adjust the tray, loosen the knobs on each side until resistance is felt, then flip the gray lever in the center of the knob fully open.

**⚠ DO NOT** continue to turn the knob counterclockwise. Forcing the knob past its stop will damage the mechanism.

The tray may now be removed completely, or adjusted to the desired position using the click detent positions as a guide. Once desired position is achieved, tighten knobs securely.



### Swing-Away Tray Depth

60. Loosen knob under the tray, pull or push into desired position. Tighten securely.

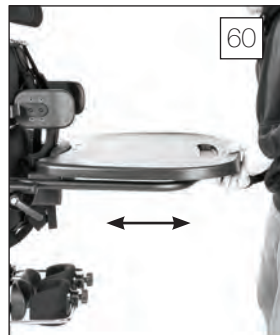

### Swing-Away Tray Angle

61. To adjust tray angle, loosen ratchet handles on both sides of the tray, set to desired position. Tighten securely.

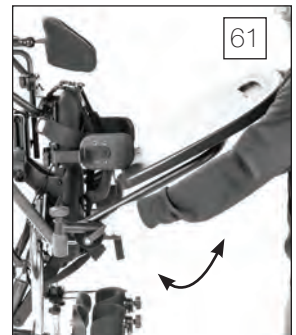

### Swing-Away Tray Swing-Away

62. Loosen knob on one side only until you are able to swing tray away.



63. Swing tray away to allow for transfers.

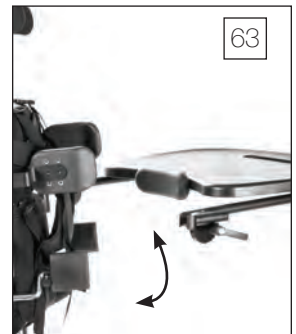



## Hip Supports

64. The hip support width can be adjusted by loosening the knobs behind the pelvic pad. Adjust to desired position and tighten securely.



65. To adjust the fore/aft positioning on the hip supports, loosen the thumb knobs and put in desired position. Adjust to desired position and tighten securely.



## Lateral Supports

66. The lateral support width and height can be adjusted by loosening the knobs on the back of the unit. Adjust to desired position and tighten securely.

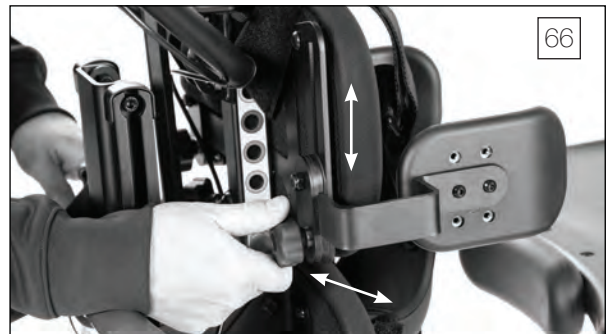

67. The lateral supports have a number of attachment holes on the back of the pad which will allow for additional positions vertically and horizontally. The pads may also be bolted at a high, low, or neutral position for greater pad range.



### Calf Pad with Knee Strap

68. To adjust the calf pad with knee strap, loosen knobs on each side. Position fore/aft and up/down to the desired setting. Tighten securely.



### Multi-Adjustable Knee Pads

69. To adjust the multi-adjustable knee pad height, loosen the ratchet handle. Adjust to desired position. Tighten securely.

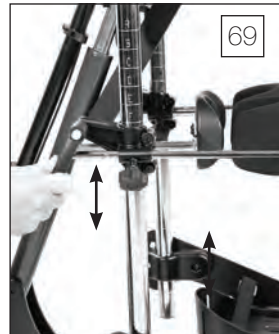

70. To adjust the multi-adjustable knee pad depth, loosen the knob. Adjust to desired position. Tighten securely.

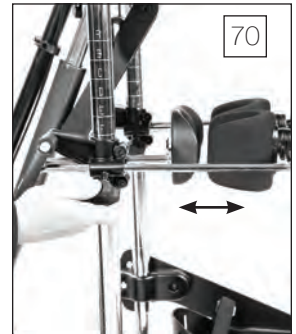

71. To adjust the multi-adjustable knee pad position, loosen knob and rotate to desired position. Tighten securely.



### Independent Adjustable Calf Pads

72. To adjust the independent adjustable calf pad depth, loosen the knob. Adjust to desired position. Tighten securely.



73. Remove bolts and position as desired to adjust calf pad height. Tighten securely.



## Upper Body Support Pad

74. To adjust the upper body support pad height, loosen knob.

75. Depress spring button and adjust to desired position. Tighten knob securely.

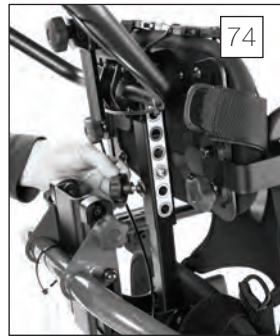

## Head Support

76. To adjust the head support depth, loosen the knob on the back of the headrest and slide into desired position. Tighten securely.



77. To adjust the head support angle, loosen the ratchet handle and place into desired position. Tighten securely.



78. To adjust the head support height, loosen the knob on the back, move to desired position. Tighten securely.



## Leg Abduction

79. Loosen knob behind the pelvic pad.



80. Abduct each leg out to the desired position up to 30 degrees per leg. Tighten securely.



## Face Aperture

81. To adjust the aperture height, loosen the knob on the support bracket. Place into desired position and tighten securely.

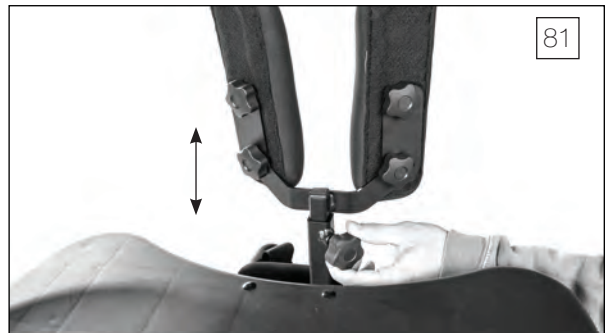

82. To adjust the angle or width of the aperture pads, loosen the knobs and place into desired position. Tighten knobs securely.





## Platform Foot Plates

83. **Height**-Platform Foot Plates are only height adjustable. Loosen knob, set to desired position. Tighten securely.

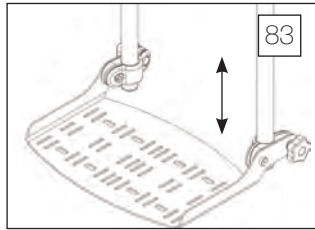

84A. **Straps (if ordered)**-Position straps into desired slots.

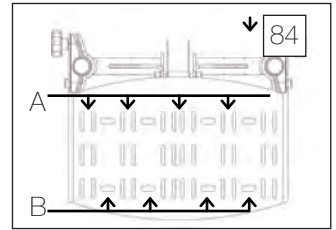

84B. **Foot Holders**-Position foot holders into desired position. Insert bolt and tighten knob securely.

## Multi-Adjustable Foot Plates

85. **Height**-Loosen the ratchet handles connecting the foot bracket to vertical leg tubes to adjust foot plate height.

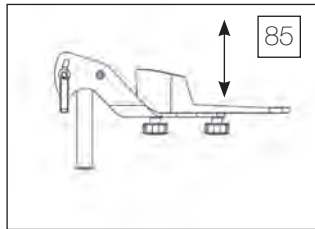

86. **Plantar/Dorsi**-Loosen ratchet handles to tilt foot plates. Tighten securely.

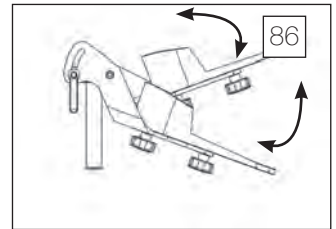

87. **Abduction**-Loosen knobs to slide foot plates together. Tighten knobs securely.

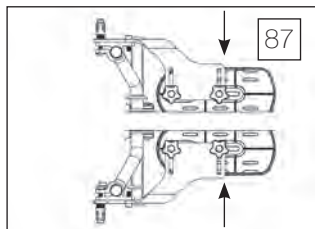

88. **Forward/Aft**-Loosen knobs underneath foot plates, slide foot plates into position. Tighten knobs securely.

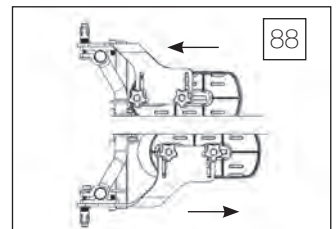

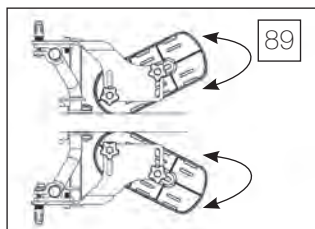

89. **Toe-in/Toe-out**-Loosen knobs underneath foot plates, slide foot plates into position. Tighten knobs securely.

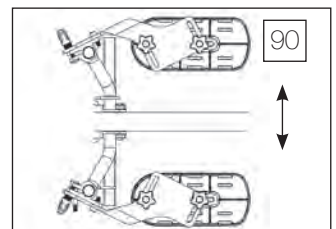

90. **Abduction**-Loosen ratchet handles to spread apart foot plates, tighten securely. Loosen knobs under foot plates and slide foot plates apart. Tighten knobs securely.



 **Caution:** Never reposition the foot plates with the child in the standing position.

 **Caution:** Avoid placing fingers in the adjustment slot.

## Supine

91. Flip the lever located behind the pelvic pad to the “supine to stand” position.

92. Adjust to the desired supine position by depressing the foot pedal or using the hand pendant on the Pow’r Up option and tilting. This can be done with the user in the unit.

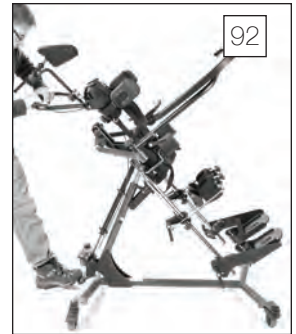

## Prone

93. Flip the lever located behind the pad to the “prone” position.

94. Adjust to the desired prone position by depressing the foot pedal or using the hand pendant on the Pow’r Up option and tilting. This can be done with the user in the unit.



## Dual Control

95. Squeeze the hand lever to place the unit in the desired position.

96. Use the foot pedal to place the unit in the desired position.



### Gas Spring Lockout

97. Pull the lockout knob out and twist to unlock. Your unit can now be positioned using the foot pedal or hand lever.

98. Twist until the knob is vertical and locks into position. The gas spring is now locked from unintended movement.



### Directional Locking Caster

99. Lock the right rear caster to allow the unit to guide straight. Locking the directional caster locks the directional position of the caster. This will not prevent the caster from rolling.





# Parts Detail- MPS

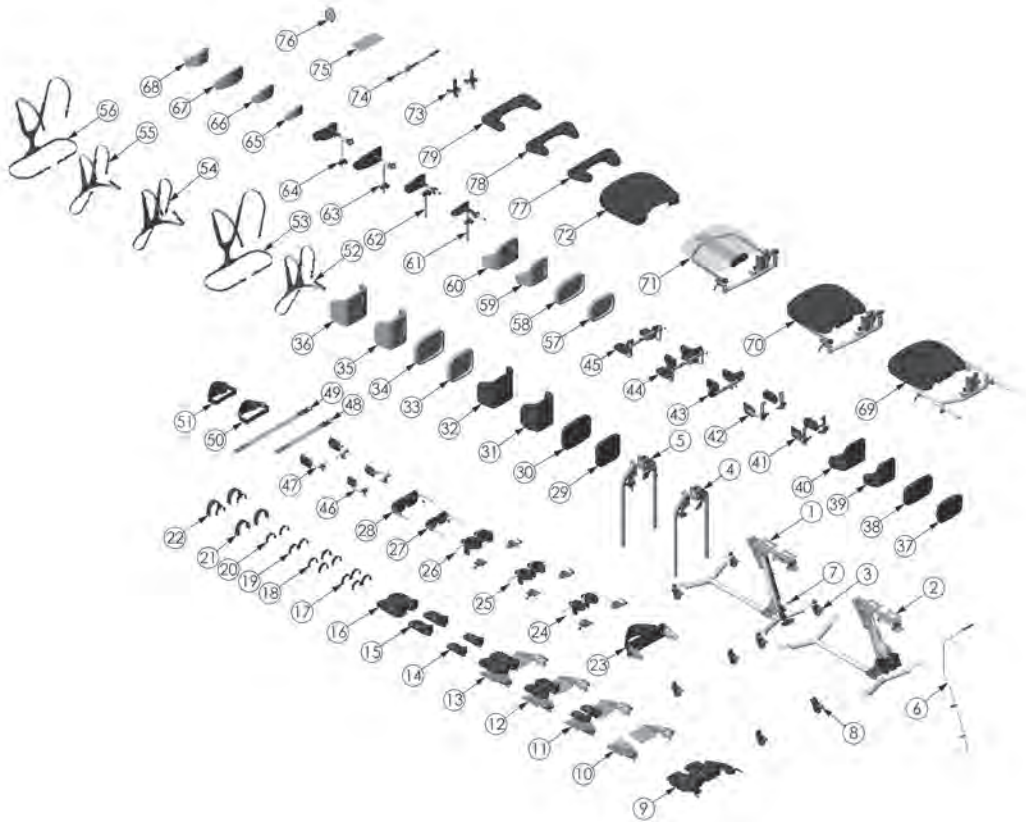

ITEM NO.	PART NO.	NAME	ITEM NO.	PART NO.	NAME
1	85500	ASMBLY ZING 2 MPS BASE GAS	51	85542	POSITIONING STRAP W/BT X 13" W PAD
2	85504	ASMBLY ZING 2 MPS BASE EL	52	T5008B	ASMBLY CHEST VEST SM
3	85508	ASMBLY CASTERS ZING SIZE 2	53	NG30021	VEST CHEST Y SHAPE ASSEMBLY LARGE
4	85512	ASMBLY LEGS BASIC ZING 2	54	NG30056	LARGE CHEST VEST EVOLV
5	85514	ASMBLY LEGS ABDUCTION ZING 2	55	NG30170	X-STYLE CHEST VEST MEDIUM
6	85516	ASMBLY DIAL LIT ZING 2	56	NG30171	Y-STYLE CHEST VEST MEDIUM
7	A5614	ASMBLY GAS SPRING LOCK OUT	57	83029	COVER HYGIENIC FOR 83001
8	85510	ASMBLY CASTERS DIRECTIONAL ZING 2	58	83030	COVER HYGIENIC FOR 83003
9	85518	ASMBLY PLATFORM FOOTPLATE ZING 2	59	83031	COVER HYGIENIC FOR 83005
10	85519	ASMBLY FOOT PLATE BRACKETS ZING 2	60	83032	COVER HYGIENIC FOR 83007
11	85520	ASMBLY FOOT MULTI-ADJ 7.75" X 3.25"	61	Y5626	ASMBLY HEAD SUPPORT XS
12	85522	ASMBLY FOOT MULTI-ADJ 9.75" X 4"	62	Y5628	ASMBLY HEAD SUPPORT SMALL
13	85524	ASMBLY FOOT MULTI-ADJ 11.75" X 5.00"	63	Y5630	ASMBLY HEAD SUPPORT LARGE
14	A5542	ASMBLY FOOT PLATES XS	64	A5586	ASMBLY HEAD REST CONTOUR SM
15	A5544	ASMBLY FOOT PLATES SM	65	A3035	SLIP COVER HEAD REST XS
16	85526	ASMBLY FOOT PLATES 11.75" X 5.00"	66	A3036	SLIP COVER HEAD REST SM
17	T50092	ASMBLY FOOT STRAP SECURE PED	67	83023	COVER HYGIENIC FOR Y5630
18	Y5638	ASMBLY FOOT STRAP SECURE 16"L	68	83057	COVER HEAD REST CONTOUR SM
19	T50080	ASMBLY FOOT STRAP PED	69	85554	ASMBLY TILT TRAY ZING 2
20	Y5636	ASMBLY FOOT STRAP 16"L	70	85556	ASMBLY TRAY SWING AWAY BLACK
21	NG50505	FOOT STRAPS 21"L	71	85558	ASMBLY TRAY SWING AWAY CLEAR
22	NG50506	SECURE FOOT STRAPS 21"L	72	NG30295	PADDED TRAY COVER
23	85528	ASMBLY CALF PAD W/STRAP ZING 2	73	NG50049	SUPPORT CRIP OPTION
24	85530	ASMBLY KNEE MULTI-ADJ ZING 2 3.25"	74	85540	ASMBLY HANDLES ZING 2
25	85532	ASMBLY KNEE MULTI-ADJ ZING 2 4.25"	75	80809	TOOL POUCH
26	85534	ASMBLY KNEE MULTI-ADJ ZING 2 5"	76	80246	SEAT ANGLE LOCATOR
27	A5678	ASMBLY CALF PAD 4.5" X 4.5"	77	T50156	ASSEMBLY ELBOW PAD 9.25" CUTOUT
28	85536	ASMBLY CALF PAD 5.5" X 5.5"	78	T50160	ASSEMBLY ELBOW PAD 5M
29	83000	PAD PELVIC 11" W ZING 2	79	Y5582	ASSEMBLY ELBOW PAD 13"
30	83002	PAD PELVIC 12" W ZING 2			
31	83004	PAD PELVIC F2F 11" W ZING 2			
32	83006	PAD PELVIC F2F 13" W ZING 2			
33	83025	COVER HYGIENIC FOR 83000			
34	83026	COVER HYGIENIC FOR 83002			
35	83027	COVER HYGIENIC FOR 83004			
36	83028	COVER HYGIENIC FOR 83006			
37	83001	PAD TORSO 11" W ZING 2			
38	83003	PAD TORSO 13" W ZING 2			
39	83005	PAD TORSO F2F 11" W ZING 2			
40	83007	PAD TORSO F2F 13" W ZING 2			
41	85544	ASMBLY LAT GUIDES ZING 2 7"-11"			
42	85546	ASMBLY LAT GUIDES ZING 2 10"-14"			
43	85548	ASMBLY ELBOW STOP ZING 2			
44	85550	ASMBLY LAT ELBOW & ARM REST ZING 2			
45	85552	ASMBLY ELBOW & ARM REST ZING 2			
46	85538	ASMBLY HIP GUIDES 7-13 ZING 2			
47	85540	ASMBLY HIP GUIDES 10-18 ZING 2			
48	A3011	POSITIONING BELT ADJUSTABLE 25 - 38"			
49	T30066	POSITIONING BELT ADJUSTABLE 34.5 - 44.5"			
50	A5610	ASMBLY CHEST STRAP MPS			

# Parts Detail- Supine

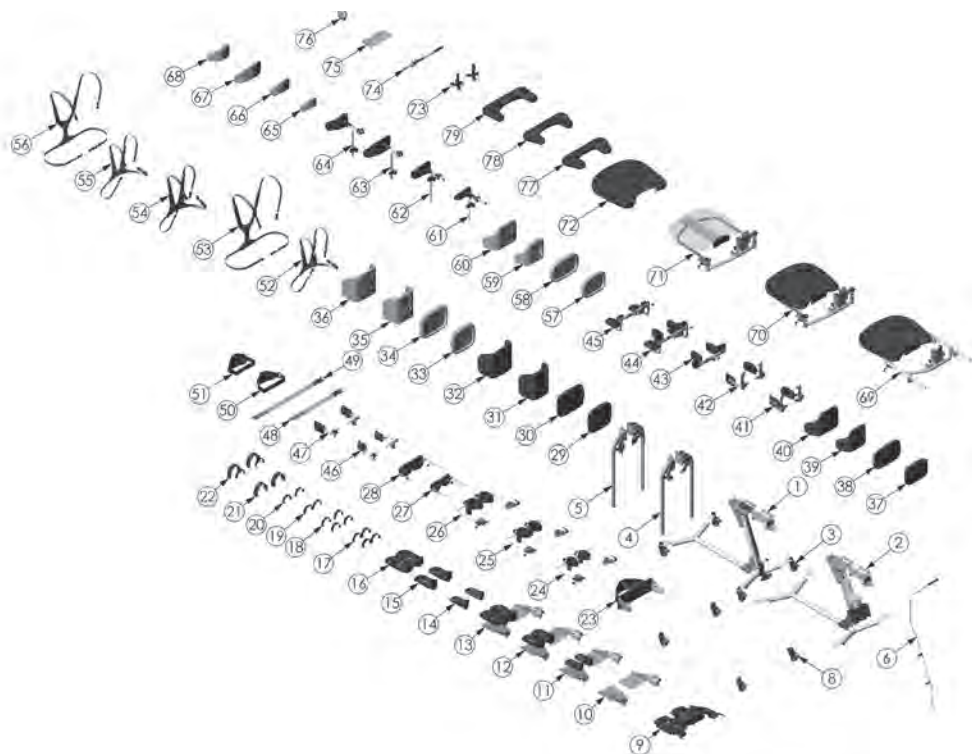

ITEM NO.	PART NO.	NAME	ITEM NO.	PART NO.	NAME
1	B5502	ASMBLY ZING 2 SUPINE BASE GAS	51	B5542	POSITIONING STRAP W/6" X 13" W PAD
2	B5504	ASMBLY ZING 2 SUPINE BASE EL	52	T50088	ASMBLY CHEST VEST SM
3	B5508	ASMBLY CASTERS ZING SIZE 2	53	NG-30021	VEST CHEST Y SHAPE ASSEMBLY LARGE
4	B5512	ASMBLY LEGS BASIC ZING 2	54	NG-30056	LARGE CHEST VEST EVOLV
5	B5514	ASMBLY LEGS ABDUCTION ZING 2	55	NG30170	X-STYLE CHEST VEST MEDIUM
6	B5516	ASMBLY DUAL LIFT ZING 2	56	NG-30171	Y-STYLE CHEST VEST MEDIUM
7	A5614	ASMBLY GAS SPRING LOCK OUT	57	B3029	COVER HYGIENIC FOR B3001
8	B5510	ASMBLY CASTERS DIRECTIONAL ZING 2	58	B3030	COVER HYGIENIC FOR B3003
9	B5518	ASMBLY PLATFORM FOOTPLATE ZING 2	59	B3031	COVER HYGIENIC FOR B3005
10	B5519	ASMBLY FOOT PLATE BRACKETS ZING 2	60	B3032	COVER HYGIENIC FOR B3007
11	B5520	ASMBLY FOOT MULTI-ADJ 7.75" X 3.25"	61	Y5626	ASMBLY HEAD SUPPORT XS
12	B5522	ASMBLY FOOT MULTI-ADJ 9.75" X 4"	62	Y5628	ASMBLY HEAD SUPPORT SMALL
13	B5524	ASMBLY FOOT MULTI-ADJ 11.75 X 5.00	63	Y5630	ASMBLY HEAD SUPPORT LARGE
14	A5542	ASMBLY FOOT PLATES XS	64	A5586	ASMBLY HEAD REST CONTOUR SM
15	A5544	ASMBLY FOOT PLATES SM	65	A3035	SLIP COVER HEAD REST XS
16	B5526	ASMBLY FOOT PLATES 11.75 X 5.00	66	A3036	SLIP COVER HEAD REST SM
17	T50082	ASMBLY FOOT STRAP SECURE PED	67	B3033	COVER HYGIENIC FOR Y5630
18	Y5638	ASMBLY FOOT STRAP SECURE 15"L	68	A3037	COVER HEAD REST CONTOUR SM
19	T50080	ASMBLY FOOT STRAP PED	69	B5554	ASMBLY TILT TRAY ZING 2
20	Y5636	ASMBLY FOOT STRAP 15"L	70	B5556	ASMBLY TRAY SWING AWAY BLACK
21	NG-50505	FOOT STRAPS 21"L	71	B5558	ASMBLY TRAY SWING AWAY CLEAR
22	NG-50506	SECURE FOOT STRAPS 21"L	72	NG-30295	PADDED HEAD COVER
23	B5528	ASMBLY CALF PAD W/STRAP ZING 2	73	NG-50042	SUPPORT GRIP OPTION
24	B5530	ASMBLY KNEE MULTI-ADJ ZING 2 3.25"	74	B5560	ASMBLY HANDLES ZING 2
25	B5532	ASMBLY KNEE MULTI-ADJ ZING 2 4.25"	75	80809	TOOL POUCH
26	B5534	ASMBLY KNEE MULTI-ADJ ZING 2 5"	76	B0246	SEAT ANGLE LOCATOR
27	A5678	ASMBLY CALF PAD 4.5" X 4.5"	77	T50156	ASSEMBLY ELBOW PAD 9.25" CUTOUT
28	B5536	ASMBLY CALF PAD 5.5" X 5.5"	78	T50160	ASSEMBLY ELBOW PAD SM
29	B3000	PAD PELVIC 11"W ZING 2	79	Y5582	ASSEMBLY ELBOW PAD 13"
30	B3002	PAD PELVIC 13"W ZING 2			
31	B3004	PAD PELVIC F2F 11"W ZING 2			
32	B3006	PAD PELVIC F2F 13"W ZING 2			
33	B3025	COVER HYGIENIC FOR B3000			
34	B3026	COVER HYGIENIC FOR B3002			
35	B3027	COVER HYGIENIC FOR B3004			
36	B3028	COVER HYGIENIC FOR B3006			
37	B3001	PAD TORSO 11"W ZING 2			
38	B3003	PAD TORSO 13"W ZING 2			
39	B3005	PAD TORSO F2F 11"W ZING 2			
40	B3007	PAD TORSO F2F 13"W ZING 2			
41	B5544	ASMBLY LAT GUIDES ZING 2 7"-11"			
42	B5544	ASMBLY LAT GUIDES ZING 2 10"-14"			
43	B5548	ASMBLY ELBOW STOP ZING 2			
44	B5550	ASMBLY LAT ELBOW & ARM REST ZING 2			
45	B5552	ASMBLY ELBOW & ARM REST ZING 2			
46	B5538	ASMBLY HIP GUIDES 7-13 ZING 2			
47	B5540	ASMBLY HIP GUIDES 10-18 ZING 2			
48	A3011	POSITIONING BELT ADJUSTABLE 25 - 38"			
49	T30066	POSITIONING BELT ADJUSTABLE 34.5 - 44.5"			
50	A5610	ASMBLY CHEST STRAP MP5			

# Parts Detail- TT MPS

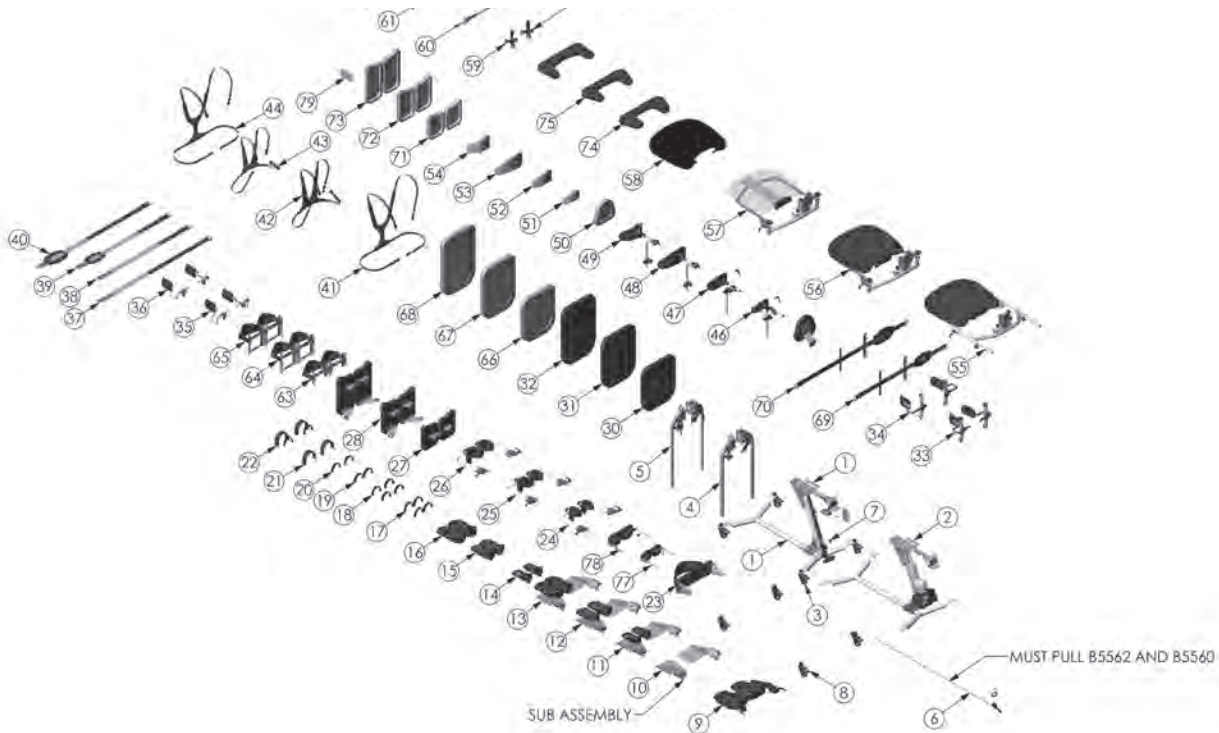

ITEM NO.	PART NO.	NAME	ITEM NO.	PART NO.	NAME
1	B5562	ASMBLY ZING 2 MPS BASE TT GAS	51	A3035	SLIP COVER HEAD REST 5" H X 8" W
2	B5566	ASMBLY ZING 2 MPS BASE TT EL	52	A3036	SLIP COVER HEAD REST 6" H X 10" W
3	B5506	ASMBLY CASTERS ZING SIZE 2	53	B3033	COVER HYGIENIC FOR Y5A30
4	B5512	ASMBLY LEGS BASIC ZING 2	54	A3037	COVER HEAD REST FORM TO FIT
5	B5514	ASMBLY LEGS ABDUCTION ZING 2	55	B5554	ASMBLY TILT TRAY ZING 2
6	B5516	ASMBLY DUAL LIFT ZING 2	56	B5556	ASMBLY TRAY SWING AWAY BLACK
7	A5614	ASMBLY GAS SPRING LOCK OUT	57	B5558	ASMBLY TRAY SWING AWAY CLEAR
8	B5510	ASMBLY CASTERS DIRECTIONAL ZING 2	58	T30093	PADDED SLIP COVER LARGE TRAY
9	B5518	ASMBLY PLATFORM FOOTPLATE ZING 2	59	NG50042	SUPPORT GRIP OPTION
10	B5519	ASMBLY FOOT PLATE BRACKETS ZING 2	60	B5560	ASMBLY HANDLES ZING 2
11	B5520	ASMBLY FOOT MULTI-ADJ 7.75" X 3.25"	61	B0809	TOOL POUCH
12	B5522	ASMBLY FOOT MULTI-ADJ 9.75" X 4"	62	B0246	SEAT ANGLE LOCATOR
13	B5524	ASMBLY FOOT MULTI-ADJ 11.75" X 5"	63	B5576	ASMBLY KNEE STRAP FOR 9" T PADS
14	A5542	FOOT HOLDERS 7.75" L X 3.25" W	64	B5578	ASMBLY KNEE STRAP FOR 12" T PADS
15	A5544	FOOT HOLDERS 9.75" L X 4" W	65	B5590	ASMBLY KNEE STRAP FOR 15" T PADS
16	B5526	ASMBLY FOOT PLATES 11.75" X 5"	66	B3035	SLIP COVER FOR B3012
17	T50082	ASMBLY FOOT STRAP SECURE PED	67	B3036	SLIP COVER FOR B3015
18	Y5638	ASMBLY FOOT STRAP SECURE 15"L	68	B3037	SLIP COVER FOR B3018
19	T50080	ASMBLY FOOT STRAP PED	69	B5596	PADDED CHEST STRAP 44" L W/ 8" L PAD
20	Y5636	ASMBLY FOOT STRAP 15"L	70	B5598	PADDED CHEST STRAP 54" L W/ 10" L PAD
21	NG50505	FOOT STRAPS 21"L	71	B5600	SLIP COVERS FOR B5570
22	NG50506	SECURE FOOT STRAPS 21"L	72	B5602	SLIP COVERS FOR B5572
23	B5528	ASMBLY CALF PAD W/ STRAP ZING 2	73	B5604	SLIP COVERS FOR B5574
24	B5530	ASMBLY KNEE MULTI-ADJ ZING 2 3.25"	74	T50186	ASSEMBLY ELBOW PAD 9.25" CUTOUT
25	B5532	ASMBLY KNEE MULTI-ADJ ZING 2 4.25"	75	T50160	ASSEMBLY ELBOW PAD 11" CUTOUT
26	B5534	ASMBLY KNEE MULTI-ADJ ZING 2 5"	76	Y5582	ASSEMBLY ELBOW PAD 13"
27	B5570	ASMBLY LEG PADS ZING 2 TT 9"L	77	A5678	ASMBLY CALF PAD 4.5" X 4.5"
28	B5572	ASMBLY LEG PADS ZING 2 TT 12"L	78	B5536	ASMBLY CALF PAD 5.5" X 5.5"
29	B5574	ASMBLY LEG PADS ZING 2 TT 15"L	79	B3049	SLIP COVER 6" LATERAL PAD
30	B3012	PAD PLANAR 18" W X 19" L			
31	B3015	PAD PLANAR 16" W X 22" L			
32	B3018	PAD PLANAR 16" W X 25" L			
33	B5588	ASMBLY LAT GUIDES 7-11" ZING 2 TT			
34	B5590	ASMBLY LAT GUIDES 10-16" ZING 2 TT			
35	B5584	ASMBLY HIP GUIDES 7-13" ZING 2 TT			
36	B5586	ASMBLY HIP GUIDES 10-16" ZING 2 TT			
37	A3062	POSITIONING BELT ADJUSTABLE 25 - 54"			
38	T30066	POSITIONING BELT ADJUSTABLE 34.5 - 44.5"			
39	B5592	PADDED STRAP 44" L W/ 8" L PAD			
40	B5594	PADDED STRAP 54" L W/ 10" L PAD			
41	NG30021	Y-STYLE CHEST VEST 20.5" L X 12.5" W			
42	NG30056	X-STYLE CHEST VEST 11" L X 9.5" W			
43	NG30170	X-STYLE CHEST VEST 9.5" W X 9" W			
44	NG30171	Y-STYLE CHEST VEST 17.5" L X 11.5" W			
45	B5582	ASMBLY PLANAR HEAD ZING 2 TT			
46	Y5626	ASMBLY HEAD SUPPORT XS			
47	Y5628	ASMBLY HEAD SUPPORT SMALL			
48	Y5630	ASMBLY HEAD SUPPORT LARGE			
49	A5586	ASMBLY HEAD REST CONTOUR SM			
50	B3038	SLIP COVER FOR B3011			



# Parts Detail- TT Supine

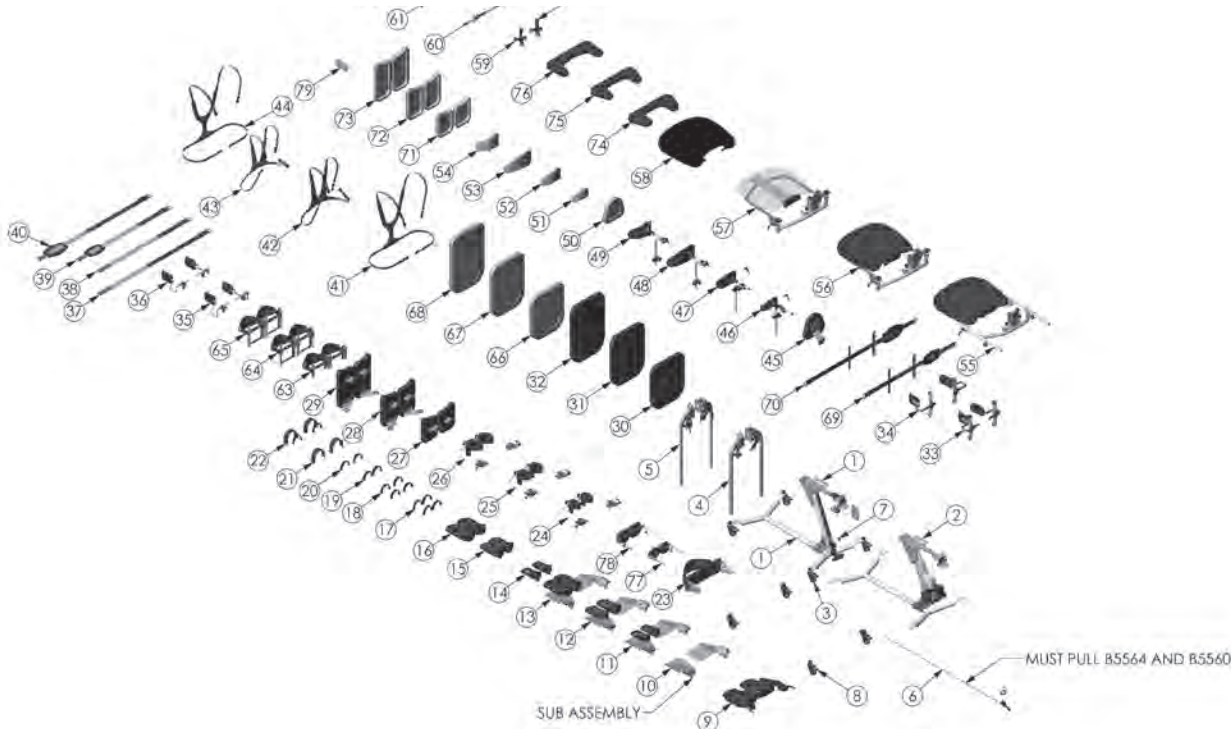

ITEM NO.	PART NO.	NAME	ITEM NO.	PART NO.	NAME
1	B5564	ASMBLY ZING 2 SUPINE BASE TT GAS	51	A3035	SLIP COVER HEAD REST 5'H X 8'W
2	B5568	ASMBLY ZING 2 SUPINE BASE TT EL	52	A3036	SLIP COVER HEAD REST 6'H X 10'W
3	B5508	ASMBLY CASTERS ZING SIZE 2	53	B3033	COVER HYGIENIC FOR Y5430
4	B5512	ASMBLY LEGS BASIC ZING 2	54	A3037	COVER HEAD REST FORM TO FIT
5	B5514	ASMBLY LEGS ABDUCTOR ZING 2	55	B5554	ASMBLY TILT TRAY ZING 2
6	B5516	ASMBLY DUAL LIFT ZING 2	56	B5556	ASMBLY TRAY SWING AWAY BLACK
7	A5614	ASMBLY GAS SPRING LOCK OUT	57	B5558	ASMBLY TRAY SWING AWAY CLEAR
8	B5510	ASMBLY CASTERS DIRECTIONAL ZING 2	58	T30093	PADDED SLIP COVER LARGE TRAY
9	B5518	ASMBLY PLATFORM FOOTPLATE ZING 2	59	NG50042	SUPPORT GRIP OPTION
10	B5519	ASMBLY FOOT PLATE BRACKETS ZING 2	60	B5560	ASMBLY HANDLES ZING 2
11	B5520	ASMBLY FOOT MULTI-ADJ 7.75" X 3.25"	61	B0809	TOOL POUCH
12	B5522	ASMBLY FOOT MULTI-ADJ 7.75" X 4"	62	B0246	SEAT ANGLE LOCATOR
13	B5524	ASMBLY FOOT MULTI-ADJ 11.75" X 5"	63	B5576	ASMBLY KNEE STRAP FOR 9'T PADS
14	A5542	FOOT HOLDERS 7.75" X 3.25" W	64	B5578	ASMBLY KNEE STRAP FOR 12'T PADS
15	A5544	FOOT HOLDERS 9.75" X 4" W	65	B5580	ASMBLY KNEE STRAP FOR 15'T PADS
16	B5524	ASMBLY FOOT PLATES 11.75" X 5"	66	B3035	SLIP COVER FOR B3012
17	T50082	ASMBLY FOOT STRAP SECURE PED	67	B3036	SLIP COVER FOR B3015
18	Y5638	ASMBLY FOOT STRAP SECURE 15"L	68	B3037	SLIP COVER FOR B3018
19	T50080	ASMBLY FOOT STRAP PED	69	B5596	PADDED CHEST STRAP 44" L W/ 8" L PAD
20	Y5636	ASMBLY FOOT STRAP 15"L	70	B5598	PADDED CHEST STRAP 54" L W/ 10" L PAD
21	NG50505	FOOT STRAPS 21"L	71	B5600	SLIP COVERS FOR B5570
22	NG50506	SECURE FOOT STRAPS 21"L	72	B5602	SLIP COVERS FOR B5572
23	B5528	ASMBLY CALF PAD W/ STRAP ZING 2	73	B5604	SLIP COVERS FOR B5574
24	B5530	ASMBLY KNEE MULTI-ADJ ZING 2 3.25"	74	T50156	ASSEMBLY ELBOW PAD 9.25" CUTOUT
25	B5532	ASMBLY KNEE MULTI-ADJ ZING 2 4.25"	75	T50160	ASSEMBLY ELBOW PAD 11" CUTOUT
26	B5534	ASMBLY KNEE MULTI-ADJ ZING 2 5"	76	Y5582	ASSEMBLY ELBOW PAD 13"
27	B5570	ASMBLY LEG PADS ZING 2 IT 9"L	77	A5678	ASMBLY CALF PAD 4.5" X 4.5"
28	B5572	ASMBLY LEG PADS ZING 2 IT 12"L	78	B5536	ASMBLY CALF PAD 5.5" X 5.5"
29	B5574	ASMBLY LEG PADS ZING 2 IT 15"L	79	B3049	SLIP COVER 6" LATERAL PAD
30	B3012	PAD PLANAR 16" W X 19" L			
31	B3015	PAD PLANAR 16" W X 22" L			
32	B3018	PAD PLANAR 16" W X 25" L			
33	B5588	ASMBLY LAT GUIDES 7-11" ZING 2 TT			
34	B5590	ASMBLY LAT GUIDES 10-16" ZING 2 TT			
35	B5584	ASMBLY HIP GUIDES 7-13" ZING 2 TT			
36	B5586	ASMBLY HIP GUIDES 10-16" ZING 2 TT			
37	A3062	POSITIONING BELT ADJUSTABLE 25 - 54"			
38	T30066	POSITIONING BELT ADJUSTABLE 34.5 - 44.5"			
39	B5592	PADDED STRAP 44" L W/ 8" L PAD			
40	B5594	PADDED STRAP 54" L W/ 10" L PAD			
41	NG30021	Y-STYLE CHEST VEST 20.5" L X 12.5" W			
42	NG30056	X-STYLE CHEST VEST 11" L X 9.5" W			
43	NG30170	X-STYLE CHEST VEST 9.5" W X 9" W			
44	NG30171	Y-STYLE CHEST VEST 17.5" L X 11.5" W			
45	B5582	ASMBLY PLANAR HEAD ZING 2 IT			
46	Y5626	ASMBLY HEAD SUPPORT XS			
47	Y5628	ASMBLY HEAD SUPPORT SMALL			
48	Y5630	ASMBLY HEAD SUPPORT LARGE			
49	A5586	ASMBLY HEAD REST CONTOUR SM			
50	B3038	SLIP COVER FOR B3011			

# Parts Detail- Prone

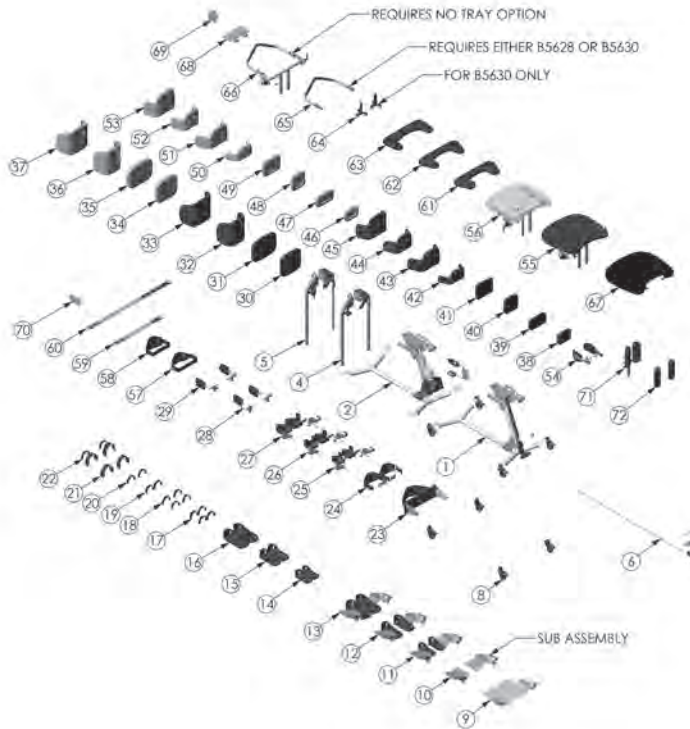

ITEM NO.	PART NO.	NAME	ITEM NO.	PART NO.	NAME
1	B5606	ASMBLY ZING 2 PRONE BASE GAS	51	B3050	SLIP COVER FOR B3046
2	B5608	ASMBLY ZING 2 PRONE BASE EL	52	A3088	SLIP COVER F2F PRONE 7'H X 12'W
3	B5606	ASMBLY CASTERS ZING SIZE 2	53	B3051	SLIP COVER FOR B3047
4	B5512	ASMBLY LEGS BASIC ZING 2	54	B5627	ASMBLY LATS ZING 2 PRONE
5	B5514	ASMBLY LEGS ABDUCTION ZING 2	55	B5628	ASMBLY TRAY ZING 2 PRONE BLK
6	B5540	ASMBLY DUAL LIFT PRONE ZING 2	56	B5630	ASMBLY TRAY ZING 2 PRONE CLEAR
7	A5614	ASMBLY GAS SPRING LOCK OUT	57	A5510	ASMBLY CHEST STRAP MPS
8	B5510	ASMBLY CASTERS DIRECTIONAL ZING 2	58	B5542	POSITIONING STRAP W/8" X 13" W PAD
9	B5612	PLATFORM FOOTPLATE ZING 2 PRONE	59	A3011	POSITIONING BELT ADJUSTABLE 25 - 38"
10	B5614	FOOT PLATE BRACKETS ZING 2 PRONE	60	T30066	POSITIONING BELT ADJUSTABLE 34.5 - 44.5"
11	B5616	ASMBLY FOOT MULTI-ADJ 7.75" X 3.25"	61	T50156	ASSEMBLY ELBOW PAD 9.25" CUTOUT
12	B5618	ASMBLY FOOT MULTI-ADJ 9.75" X 4"	62	T50160	ASSEMBLY ELBOW PAD 11" CUTOUT
13	B5620	ASMBLY FOOT MULTI-ADJ 11.75" X 5"	63	Y5582	ASSEMBLY ELBOW PAD 13"
14	A5542	FOOT HOLDERS 7.75" L X 3.25" W	64	NG50042	SUPPORT GRIP OPTION
15	A5544	FOOT HOLDERS 9.75" L X 4" W	65	B5632	HANDLE TRAY ZING 2 PRONE
16	B5526	ASMBLY FOOT PLATES 11.75" X 5"	66	B5634	HANDLE NO-TRAY ZING 2 PRONE
17	T50082	ASMBLY FOOT STRAP SECURE PED	67	T30093	PADDED SLIP COVER LARGE TRAY
18	Y5638	ASMBLY FOOT STRAP SECURE 15"L	68	80809	TOOL POUCH
19	T50080	ASMBLY FOOT STRAP PED	69	80246	SEAT ANGLE LOCATOR
20	Y5636	ASMBLY FOOT STRAP 15"L	70	B3049	SLIP COVER 6" LATERAL PAD
21	NG50505	FOOT STRAPS 21"L	71	B5638	ASMBLY FACE PROMPT ZING 2 PRONE
22	NG50506	SECURE FOOT STRAPS 21"L	72	A5710	ASMBLY SLIP COVERS FACE PROMPT 9"
23	B5528	ASMBLY CALF PAD W/STRAP ZING 2			
24	B5636	ASMBLY KNEE STRAP PRONE SIZE 2			
25	B5622	MULTI-ADJ KNEE PADS 3.25" PRONE			
26	B5624	MULTI-ADJ KNEE PADS 4.25" PRONE			
27	B5626	MULTI-ADJ KNEE PADS 5" PRONE			
28	B5538	ASMBLY HIP GUIDES 7"-12" ZING 2			
29	B5540	ASMBLY HIP GUIDES 12"-18" ZING 2			
30	B3000	PAD PELVIC 11" W ZING 2			
31	B3002	PAD PELVIC 13" W ZING 2			
32	B3004	PAD PELVIC F2F 11" W ZING 2			
33	B3006	PAD PELVIC F2F 13" W ZING 2			
34	B3025	SLIP COVER FOR B3000			
35	B3026	SLIP COVER FOR B3002			
36	B3027	SLIP COVER FOR B3004			
37	B3028	SLIP COVER FOR B3006			
38	A3006	PAD PLANAR 5" X 7"			
39	A3007	PAD PLANAR 5" X 9"			
40	A3041	PAD PLANAR 2" X 7"			
41	A3042	PAD PLANAR 7" X 9"			
42	A3079	PAD F2F PRONE 5" H X 12" W			
43	B3046	PAD F2F PRONE 6" H X 13" W			
44	A3081	PAD F2F PRONE 7" H X 12" W			
45	B3047	PAD F2F PRONE 10" H X 13" W			
46	A3028	SLIP COVER PLANAR 5" X 7"			
47	A3029	SLIP COVER PLANAR 5" X 9"			
48	A3045	SLIP COVER PLANAR 7" X 7"			
49	A3046	SLIP COVER PLANAR 7" X 9"			
50	A3086	SLIP COVER F2F PRONE 5" H X 12" W			



# Maintenance

## **Cleaning/Disinfecting**

- Clean the EasyStand with a mild, non-abrasive disinfectant or soap and water.
- Check the EasyStand at least weekly to ensure all nuts, bolts and adjustable parts are tightened securely, failure to do so may result in parts falling off which may cause a choking hazard for children.
- Do not use bleach or any other bleach-based cleaners on the EasyStand.
- Disinfecting wipes are safe to use on metal and non-porous surfaces.
- Use a damp sponge with mild soap or a mild, non-abrasive disinfectant.
- Spot clean Neoprene with mild soap and water.
- Hygienic covers may be removed and hand washed with water. Air dry the covers. Always use care when removing and replacing the covers.
- Do not dry clean any upholstery items.
- If the EasyStand is being used with one user, clean the EasyStand on a monthly basis or as needed.
- If the EasyStand is being used in a multiple-user environment, the EasyStand should be cleaned after each use.

## **Urethane Coated Fabrics and Hygienic Washable Covers (Dartex or generic equivalent)**

- The recommended cleaning and disinfection instructions should be followed whenever possible to avoid damage to the PU membrane which could lead to premature failure of the cover.
- For superficial dirt, use a disposable wipe and a warm solution of neutral detergent. Do not use abrasive cleaners.
- Disinfect using a 0.1% sodium hypochlorite solution (1000ppm chlorine), stronger bleach solutions not recommended.
- Thoroughly rinse any remaining cleaning solution with water and dry fabric before re-use or storage.
- Do not iron.

# Limited Warranty

This warranty is extended only to the original purchaser/customer (or supplier/non consumer who does not buy or resell). Altimate Medical, Inc., warrants the EasyStand against defects in materials and workmanship as listed below.

- Steel Frames - 5 year warranty
- Gas Spring- 2 year warranty
- Upholstered components, plastic pads, rubber parts, painted surfaces, bearings and other parts not specifically identified above - 90 day warranty

Warranty on Electric lift option components is as follows:

- Actuator & Hand Pendant - 2 year warranty
- Control Box & Battery - 90 days
- Battery Charger - 90 days

The warranty period commences for the consumer on the purchase date from the seller/supplier. If the product is rented or otherwise not sold to a consumer, the warranty period commences from the date of invoice from Altimate Medical. Any product proven to Altimate Medical satisfaction to be defective and within warranty period, shall be repaired or replaced at Altimate Medical's option.

ALTIMATE MEDICAL SOLE OBLIGATION AND YOUR EXCLUSIVE REMEDY UNDER THIS WARRANTY SHALL BE LIMITED TO SUCH REPAIR AND/OR REPLACEMENT. This warranty does not include any labor charges incurred in replacement parts installation. Freight charges to factory are at the expense of consumer to seller. Return freight charges will be prepaid by Altimate Medical. For warranty service, please contact the authorized supplier from whom you purchased your Altimate Medical product. In the event you do not receive satisfactory warranty service, please write directly to Altimate Medical at the address below. Do not return products to our factory without prior authorization.

LIMITATIONS AND EXCLUSIONS: The foregoing warranty shall not apply to serial numbered products if the serial number has been removed or defaced. Products subject to negligence, abuse, misuse, improper operation, improper maintenance, improper storage, or damages beyond Altimate Medical's control are not covered by this warranty, and that evaluation will be solely determined by Altimate Medical. Products modified without Altimate Medical's express written consent (including, but not limited to, modification through the use of unauthorized parts or attachments) are not covered by this warranty. The warranty shall not apply to problems arising from normal wear or failure to follow instructions. The warranty will be void if parts not manufactured by Altimate Medical or parts not complying with original equipment specifications are added to an Altimate Medical product.

THE FOREGOING WARRANTY IS EXCLUSIVE AND IN LIEU OF ALL OTHER EXPRESS WARRANTIES. ALTIMATE MEDICAL SHALL NOT BE LIABLE FOR ANY CONSEQUENTIAL OR INCIDENTAL DAMAGES WHATSOEVER.

Altimate Medical maintains a policy of continual product improvement and reserves the right to change features, specifications, and prices without prior notification. Check with Altimate Medical for latest information.

Altimate Medical, Inc., 262 W. 1st St., Morton, MN 56270 USA  
Phone: 507.697.6393 Toll Free: 800.342.8968 Fax: 507.697.6900  
easystand.com info@easystand.com

## Environmental Issues

After life of the product:

- Recycle in accordance with the recycling codes of your country.
- Recycle all metal parts.
- Plastic parts should be disposed of or recycled according to the directive in your country.
- Please inquire at your local disposal management and recycling center for local codes.
- Return gas spring cylinder to Altimate Medical, Inc. if no local recycling is available.